

| Industry General Catalogue

> Welcome to the SNR Universe



Industry





SNR, a renowned brand, essential values

For more than a century, SNR has focused its bearing design, development and manufacturing activity in sectors where this component, which is often unseen, plays an essential and sometimes vital role.

SNR is now present on the five continents. This worldwide success is grounded on the essential values which made the company's strength: permanent innovation, experience of the teams and a close relationship to our clients.

Innovation, which has always been and will always be a major asset for SNR, is now expressed through the corporate policy devoted to fundamental and applied research. Strengthened by its success in major programs in all sectors of aerospace, rail, automotive (ASB bearing) and general industry, this policy purports to address the needs expressed by more and more demanding clients.

Long term team experience and expertise are complementary and indispensable for the company's prominence and renown. They are a guarantee of professional experience and credibility: values upon which our clients can rely.

Acknowledged as a human-sized business, SNR has always favoured confidence and close contact relationships with its clients and cooperating contractors, grounded on a sense of respect.

"United, we stand": SNR has now initiated a process of integration into the NTN Group, world No. 5 in the bearing sector.

With SNR's capacities and strength, NTN obtains a powerful ally in order to extend its activities worldwide and particularly in Europe. For SNR, this evolution is a new opportunity to offer an even wider product range, and even higher performance in its service.

You have clearly understood that expertise, service and innovation are the company's true drivers.

To promote the international development of its clients, SNR wishes to share its passion of the bearing with you. Do not hesitate to contact us.

"SNR, our bearings revolve around you"

Patrick Désire
SNR Industry Division Manager



Foreword

SNR industry's general catalogue provides all information on standard bearings and accessories used both for OEM and Aftermarket. Therefore, this catalog exhibits SNR's experience and state-of-the art know-how.

A system of tabs was implemented to facilitate the identification of the various product families. In addition, you will find in each chapter technical information necessary to determine the optimum bearing selection.

The SNR Technical Catalogue is designed to give you the information you will need to:

- become familiar with the SNR bearings and their characteristics
- select the bearing that meets the specification of the application in question and to calculate its service life
- determine its means of retention, adjustment and maintenance.

The SNR Technical Services are at your disposal to assist you with the interpretation of the information given, and to complete the advice and recommendations regarding the bearings and their integration into your application. If the economic and technical conditions justify it, SNR can propose an adapted or completely customized bearing.

To obtain the best performance from an SNR bearing, it is recommended to use it in accordance with the general instructions given in this Technical Catalogue, observing the operating and environmental conditions that determined its selection.

SNR assistance applies to the complete bearing rotation function without extending to the function of the host application, which remains the responsibility of the original equipment manufacturer.

This catalogue is also available in electronic version and can be downloaded from our website: www.snr-bearings.com

Although every effort has been made to ensure the accuracy of the information contained in the Technical Catalogue, SNR ROULEMENTS assumes no liability for any errors or omissions. Owing to our continuing research and development policy, we reserve the right to change all or part of the design and specifications of all or part of the products mentioned in this document without notice.

This Technical Catalogue supersedes document TN04.

SNR copyright international 2009

Content



General Data	5
Bearing Technology	37
Bearing life	55
Bearing retention and clearances	89
Lubrication	121
Fitting-removal and maintenance	135
Appendices and terminology	147

→ Single-row radial ball bearings	153
Single-row angular contact ball bearings	231
Double row ball bearings	261
Cylindrical roller bearings	291
Tapered roller bearings	313
Double-row spherical roller bearings	333
Thrust bearings	377
Sleeves and Accessories	391
Self-aligning bearings	421
Split pillow blocks	637
Maintenance	669
Other products	677
Mechatronics	695



- SNR has standardised the designations of dimensions within the various types of bearings.

Across all types, the subscript of a dimension now becomes the same. Technical drawings will be easier to understand.

This standardisation will help you select your bearings.

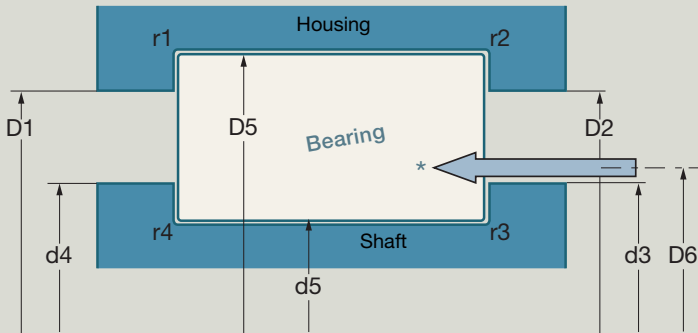

*direction of oil flow (for machine tool bearings)

General Data

Types of bearings	6
■ Definitions	6
■ Vocabulary	8
■ Capabilities	9
Standardization and interchangeability	12
■ The Standards	12
■ Interchangeability	12
Dimensions and part numbers	14
■ General designations	14
<i>Complete reference</i>	14
<i>Basic reference</i>	15
■ Designations of tapered roller bearing	16
■ Designation of special bearings	17
Bearing manufacturing precision	18
■ Standardization	18
<i>Tolerance definition</i>	19
<i>Equivalence of bearing precision standards</i>	22
■ Bearing tolerances	22
<i>Radial bearings - Normal tolerance classes</i>	23
<i>High-precision radial bearings - Tolerance class 6</i>	24
<i>High-precision radial bearings - Tolerance class 5</i>	25
<i>High-precision radial bearings - Tolerance class 4</i>	26
<i>High-precision radial bearings - Tolerance class 2</i>	27
<i>Tapered roller bearings - Normal tolerance class</i>	28
<i>High-precision tapered roller bearings - Tolerance class 6X</i>	29
<i>High-precision tapered roller bearings - Tolerance class 5</i>	30
<i>Ball thrust bearings - Normal tolerance class</i>	31
<i>Tapered bores: 1:12 and 1:30 taper</i>	32
Bearings initial radial internal clearance	34
■ Radial clearance of radial contact bearings. Definition	34
■ Internal radial clearance groups	34
Axial clearance of angular contact bearings	35
■ Recommended axial clearance	35

Types of bearings

Definitions

A bearing is a mechanical unit that provides a mobile link between two parts that rotate in relation to one another. Its function is to permit relative rotation of these parts, under load, with accuracy and minimum friction.

















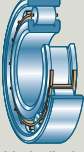





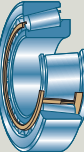





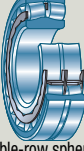



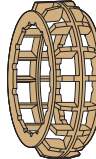
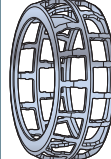

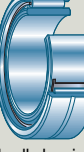



■ A bearing consists of:

- two rings, one associated with a fixed element, the other with the moving element and featuring raceways
- rolling elements allowing relative displacement of the two rings with minimum friction
- a cage separating the rolling elements

■ There are two large bearing families:

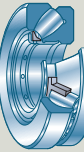
- ball bearings, allowing high speeds of rotation and where the ball-raceway interface is theoretically point contact
- roller bearings, where the ball-raceway interface is theoretically line contact. Roller bearings can withstand higher radial loads than ball bearings



Type	Outer ring	Inner ring	Rolling elements	Synthetic material	Pressed steel	Integrally machined
 Ball bearing						
 Cylindrical roller bearing						
 Tapered roller bearing	 (cup)	 (cone)				
 Double-row spherical roller bearing						
 Needle bearing						
 Ball thrust bearing	 (housing ring)	 (shaft ring)				
 Spherical roller thrust bearing	 (housing ring)	 (shaft ring)				

Types of bearings (continued)

Vocabulary

Standard ISO 5593 has established a vocabulary of standard terms applicable to bearings and bearing technology.

The terms and definitions are given in a multilingual glossary.

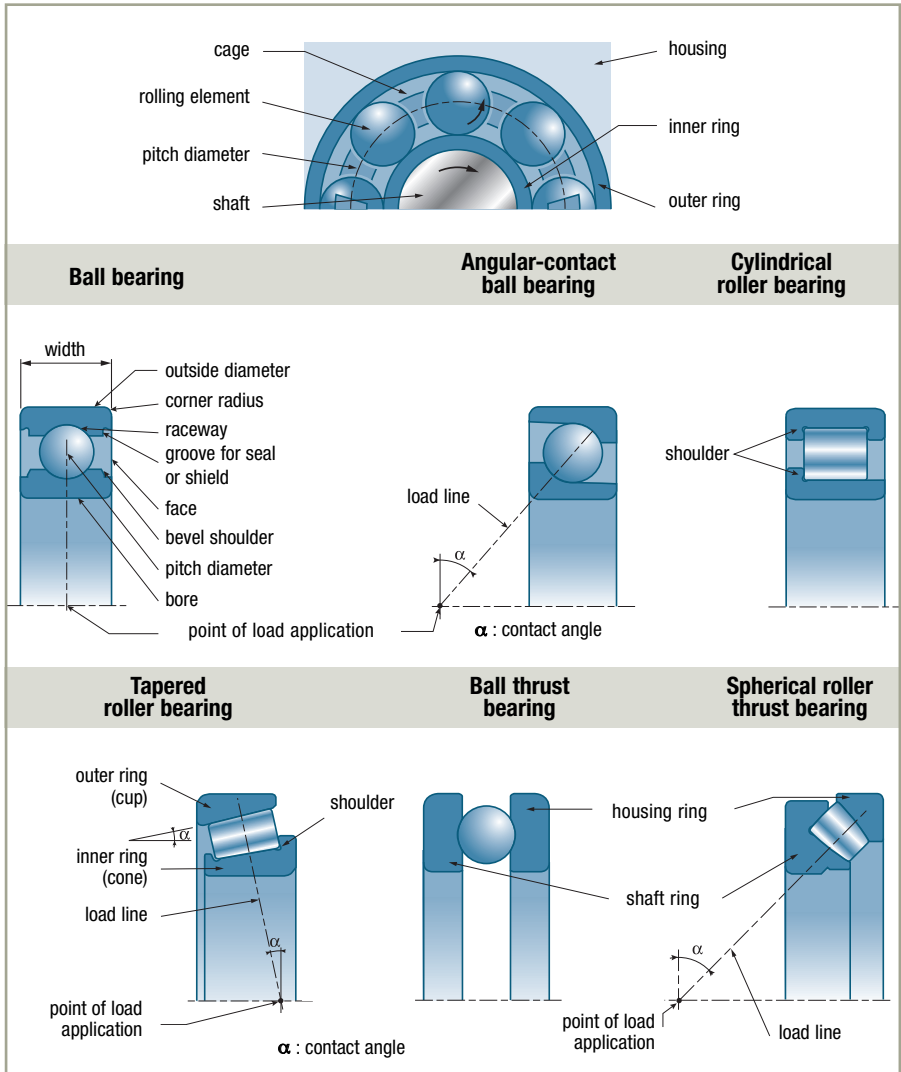

Capabilities

General characteristics and capabilities

Application examples

■ Ball bearings

▶ Single- or double-row radial ball bearings

Popular bearings due to their cost/performance compromise.

Numerous variants (shielded, sealed etc.) and large selection of dimensions.

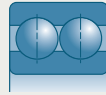

Electric motor
Wheel of trailer
Household electrical appliances
Woodworking machine spindles
Small reducing gear
Gear box

▶ Single-row angular-contact ball bearings

Always mounted in opposition with another bearing of the same type.

Give great assembly rigidity, especially when preloaded

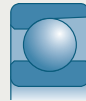

Reduction gear box
Machine-tool spindle

▶ Double-row angular-contact ball bearings

Withstand axial loads in both directions.

Can be used alone as a double bearing.

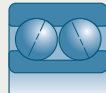

Reducing gear
Automobile wheels
Agricultural machinery

▶ 4-point angular contact ball bearings

Withstand axial loads in both directions.

Often associated with a radial contact bearing.



Reducing gear

■ Double-row self-aligning ball or spherical roller bearings

▶ Double-row self-aligning ball bearings

The spherical raceway of the outer ring permits angular displacement.

A variant with a tapered bore simplifies fitting.



For long shaft with deflection

▶ Spherical roller bearings

The spherical raceway of the outer ring permits angular displacement

A variant with a tapered bore simplifies fitting.



Roll stand
Large reducing gear
Large industrial fan
Printing machine roller
Quarry machine

Types of bearings *(continued)*

General characteristics and capabilities

Application examples

■ Roller bearings

▶ Cylindrical roller bearings

Excellent resistance to instantaneous overloads and shocks.

Simplification of installation thanks to their detachable elements.

Certain types allow axial displacement; others allow a low axial load.



Heavy-duty electric motor
Wagon axle box
Pressure roller
Rolling machine roll

▶ Single-row tapered roller bearings

Always mounted in opposition with another bearing of the same type.

Give great assembly rigidity, especially when preloaded.

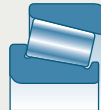

Reducing gear shaft
Truck wheel
Bevel gear transfer gearbox

▶ Double-row tapered roller bearings (SNR TWINLINE)

Accept axial loads in both directions.

Often used alone as a double bearing.



TGV high-speed train axle box
Automobile wheel

▶ Needle bearings

Accept relatively high radial loads with small space requirement and high radial rigidity.



■ Thrust bearings

Thrust bearings are often used with other types of bearing.

▶ Ball thrust bearings

Withstand axial loads only.

If radial load is applied must be associated with a radial bearing.



Vertical shaft
Tailstock
Plate pump

▶ Spherical roller thrust bearings

Can withstand a radial and axial load while accepting misalignment.



Heavy-duty vertical shaft
Turbo-generator
Crane pivot
Plastic injection screw

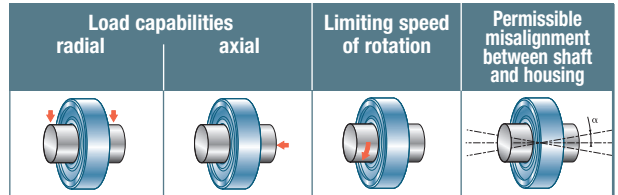

Types	Cross-section	low			medium			good			low		good	
Radial ball bearing														●
Double-row radial ball bearing														●
Angular-contact ball bearing														●
4-point angular-contact ball bearing														●
Double-row angular contact ball bearing														●
TWINLINE angular contact ball bearing														●
Double-row self-aligning ball bearing														●
Cylindrical roller bearing (1)														●
Tapered roller bearing														●
TWINLINE tapered roller bearing														●
Double-row spherical roller bearing														●
Single-direction ball thrust bearing														●
Spherical roller thrust bearing														●

(1) Types NJ and NUP accept low axial loads

Standardization and interchangeability

The standards

The mission of the International Standard Organisation (ISO) is to develop and coordinate standardization to facilitate the trade of products and services between nations. It encompasses the standards committees of 89 countries (AFNOR-France, DIN-Germany, UNI-Italy, BS-Great Britain, ANSI-United States, etc.).

Bearing standardization is the responsibility of the ISO Technical Committee "TC 4" in which SNR plays an active part. The main standards used for bearings and thrust bearings are specified in the appendix page 147.

Interchangeability

■ **Dimensional interchangeability** is guaranteed by the values and tolerances on the bearing dimensions: d , D , B , C , r and T .

- d Bore diameter
- D Outside diameter
- B Width of bearing or width of inner ring (cone)
- C Width of bearing or width of outer ring (cup)
- T Width or total height
- r Corner radius

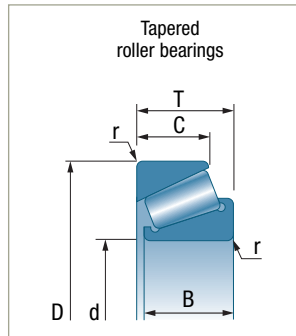
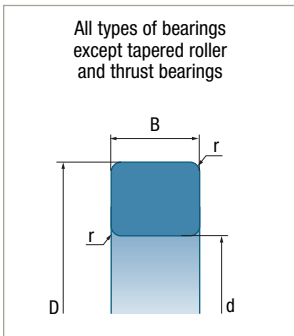

Strict application of the standards in the manufacture of the bearing enables one to obtain full interchangeability between bearings of the same part number, whoever the manufacturer, place or date of production.

Standardization of the bearing also allows **dimensional interchangeability between bearings of different types**, either total or partial. It is necessary to ensure the functional interchangeability.

■ Bearing series codes according to the different outside diameters and widths

For a given bore the standards provide for several diameter series (series 8, 9, 0, 1, 2, 3, 4 in ascending order).

For each diameter series there are several width series (series 0, 1, 2, 3, 4 in ascending order).

■ Interchangeability of detachable elements of cylindrical or tapered roller bearings

Cylindrical or tapered roller bearings can be separated into two parts: a ring that is joined to the cage and rollers and a bare ring.

Cylindrical roller bearings

Interchangeability is ensured by the dimensions below the rollers F and above the rollers E .

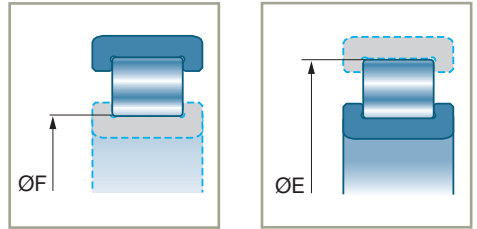

Tapered roller bearings

The interchangeability of the internal sub-assemblies (fitted cones) and outer rings (cups) is ensured by standard ISO 355 which defines the contact angle α and the theoretical inside diameter of the cup E . One must check that the bearings are indeed identical (same suffix).

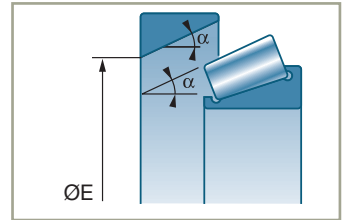

Caution : There is full interchangeability between SNR elements. ISO has standardized the values of the above dimensions without specifying their tolerances. Consequently, although the assembly of elements from different manufacturers presents no risk, it does not always give optimum performance and should therefore be avoided.

Dimensions and part numbers

General designations

ISO has established standards in the form of a general plan of dimensions corresponding to standards ISO 15, ISO 355 and ISO 104. These standards allow universal use of the different types of bearings.

- The general designation system taken from standards ISO 15 and ISO 104 applies to all types of standardized bearings
 - Tapered roller bearings have specific designations taken from standard ISO 355
- The special bearings have a specific numbering system.

→ Complete part number

- Each bearing part number is comprised of the following components:

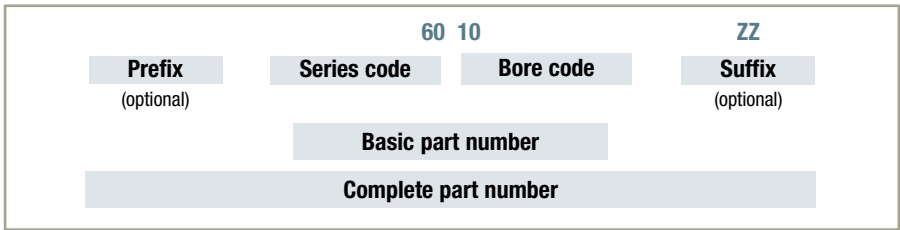



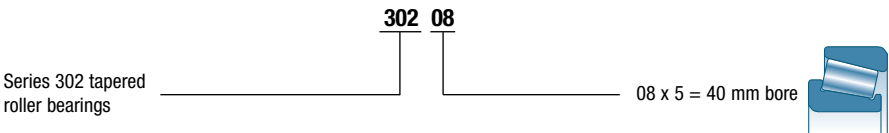
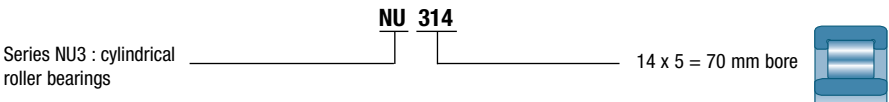
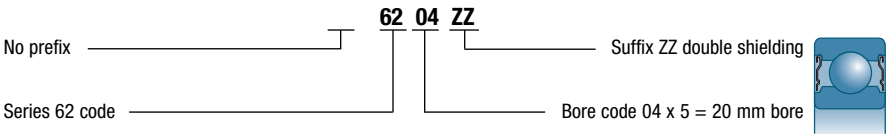









Examples:



The table on the following page specifies the different possibilities for the series codes and bore codes. The main suffixes and prefixes are specified in the chapter corresponding to each family.

→ **Basic part number**

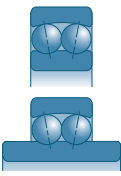
60 XX

Part number	Type of bearing	Part number	Type of bearing	Bore code	Bore diameter mm
60 X 62 X 63 XX 64 XX 160 XX 618 XX 619 XX 622 XX 623 XX	Radial ball bearing  With 1 row of balls	72 XX 73 XX 718 XX	Angular-contact ball bearing  With 1 row of balls	3 /4 4	3 4 4
2 XX 3 XX	 With a filling slot	QJ2 XX QJ3 XX	 With 4 points of contact	5 6 /6	5 6 6
42 XX 43 XX	 With 2 rows of balls	32 XX 33 XX	 With 2 rows of balls	7 /7	7 7
		52 XX 53 XX	 With 2 rows of balls ZZ or EE	8 /8	8 8
302 XX 303 XX 313 XX 320 XX 322 XX 323 XX 330 XX 331 XX 332 XX	Tapered roller bearing 	213 XX 222 XX 223 XX 230 XX 231 XX 232 XX 240 XX 241 XX	Double-row spherical roller bearing 	9 00 01 02 03 /22 /28 /32	10 12 15 17 22 28 32
N..2 XX N..3 XX N..4 XX N..10 XX N..22 XX N..23 XX	Cylindrical roller bearing  NU N NJ NUP	511 XX 512 XX 513 XX 514 XX	Ball thrust bearing 	04 05 06 07 08 09 10	04x5 = 20 05x5 = 25 06x5 = 30 07x5 = 35 08x5 = 40
12 XX 13 XX 22 XX 23 XX 112 XX 113 XX	Double-row self-aligning ball bearing  Wide inner ring	293 XX 294 XX	Spherical roller thrust bearing 		

Dimensions and part numbers (continued)

Designations of tapered roller bearings

Standard ISO 355 defines the series of dimensions of tapered roller bearings.

➔ The old part numbering system has been maintained in this catalog. The new designation is however mentioned for the bearings of the new series.

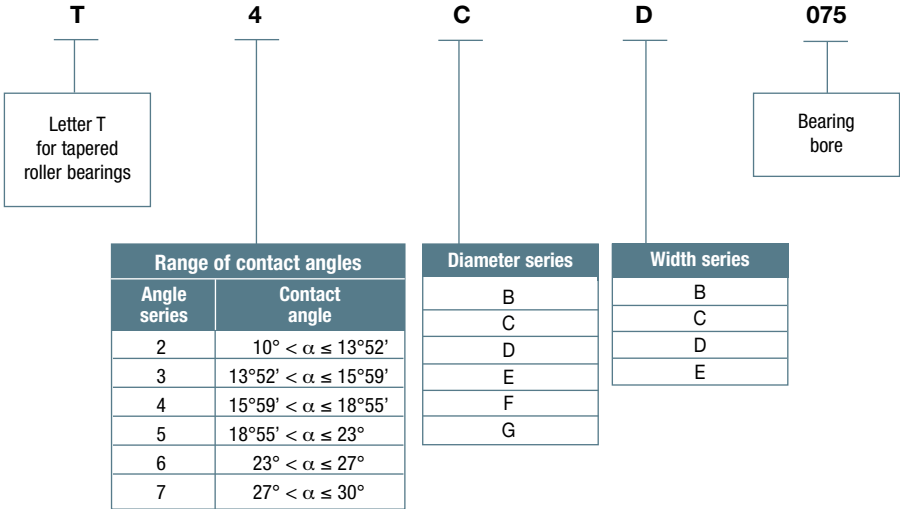



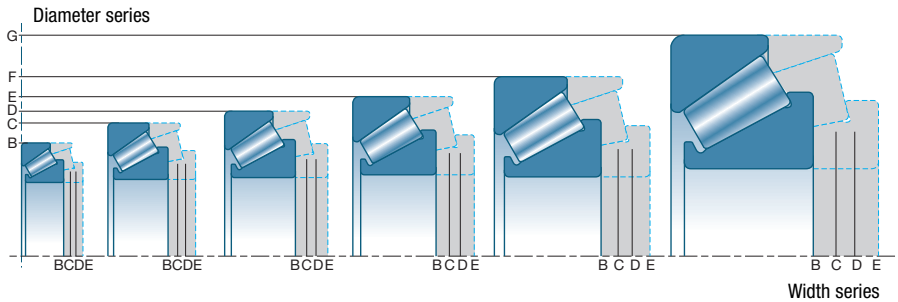





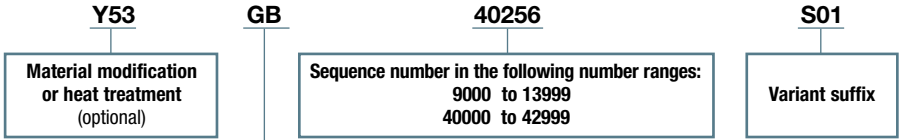





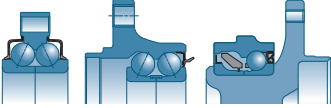

Width and diameter series



Designation of special bearings

The part numbers of special bearings is not standard and is specific to each manufacturer. The designation system defined by SNR is given below.



	Type of bearing	Examples
AB	Single-row radial contact ball bearing	
BB	Single-row angular contact ball bearing	
GB	Two-part double-row angular contact ball bearing	
TGB	Single-flange double-row angular contact ball bearing	
HGB	Two-flange double-row angular contact ball bearing	
DB	Double-row radial contact ball bearing	
AP	Ball thrust bearing	
QJ	4-point angular contact bearings	
TJ	3-point angular contact bearings	
N..	Cylindrical roller bearing: N, NU, NUP	
GNU	Cylindrical roller bearing	
EC	Single-row tapered roller bearing	
FC	Double-row tapered roller bearing	
TFC	Single-flange double-row tapered roller bearing	
QR	Crossed roller bearing	
X...	Sensor bearings XGB, XTGB, XHGB, XFC, XTFC	
CH	Ceramic Rolling Elements	

Bearing manufacturing precision

Standardization

■ Standard **ISO 492** specifies the tolerances applicable to the dimensions and precision of rotation of metric series radial bearings.

The dimensional tolerances defined by this standard bear the following symbols:

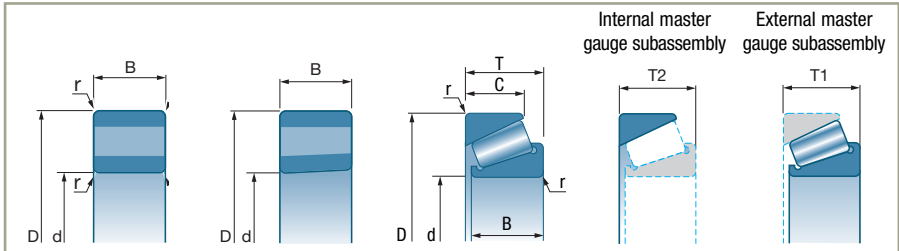

■ Tolerance classes defined by standard **ISO 492**:

- ▶ The **Normal** class, which is that of all the standard bearings, and is not usually indicated in the bearing designation
- ▶ The **High precision** classes which are, in ascending order of precision: ISO 6, ISO 5, ISO 4, ISO 2

These classes are indicated in the suffix added to the bearing reference.

Example:

Clearance category 3 C3 P5 ISO precision class 5

Standard **ISO 199** sets the tolerances on thrust bearing dimensions.

Standard **ISO 582** sets the tolerances on bearing corner radii. The dimensions applicable to fillets and shoulders are indicated in the table of bearing characteristics.

Standard **ISO 5753** defines the tolerances on the radial clearance of the bearings.

→ Tolerance definition

The tolerance classes fix several types of tolerances and characteristics given for a temperature of $20^{\circ}\text{C} \pm 1^{\circ}\text{C}$ ($68^{\circ}\text{F} \pm 1.8$).

■ Dimensional tolerances

Standard **ISO 492** sets the tolerances for the three main dimensions of a bearing:

- the bore diameter d
- the outside diameter D
- the width of each ring B and C with, in addition, for tapered bearings, the total width T

■ Functional tolerances

The standard also defines the precision of rotation of the bearings:

- the raceway radial runout of each ring. It is measured on the moving ring with respect to the fixed ring
- side face runout with reference to the bore of the inner ring
- outer ring side face runout with respect to the outer diameter
- side face runout with respect to the track

Bearing manufacturing precision *(continued)*

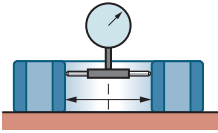
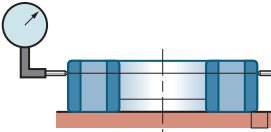
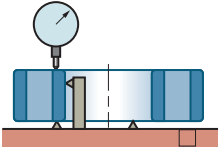
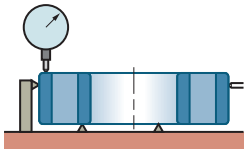
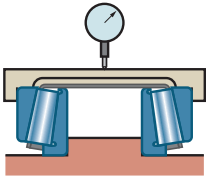
Dimensional tolerances	Deviations
<p>d: nominal bore diameter</p> 	<p>Δd_{mp} • Deviation of a mean bore diameter in an isolated plane (tolerance on the mean diameter)</p> <p>V_{dp} • Variation in the bore diameter in an isolated radial plane (ovality)</p> <p>V_{dmp} • Variation in the mean bore diameter (applies only to a supposedly cylindrical bore) in different planes</p>
<p>D: nominal outside diameter</p> 	<p>ΔD_{mp} • Deviation of a mean outside diameter in an isolated plane (tolerance on the mean diameter)</p> <p>V_{Dp} • Variation in the outside diameter in an isolated radial plane (ovality)</p> <p>V_{Dmp} • Variation in the mean outside diameter in different planes</p>
<p>B: nominal width of ring</p> 	<p>ΔB_s • Deviation of an isolated width of the inner ring (width tolerance)</p> <p>V_{B_s} • Variation in the width of the inner ring (face parallelism)</p>
<p>C: nominal width of ring</p> 	<p>ΔC_s • Deviation of an isolated width of the outer ring (width tolerance)</p> <p>V_{C_s} • Variation in the width of the outer ring (face parallelism)</p>
<p>T : nominal width of tapered bearing</p> <p>T1: effective nominal width of the internal sub-assembly</p> <p>T2: effective nominal width of the external sub-assembly</p> 	<p>ΔT_s • Deviation in the actual width of the bearing</p> <p>$\Delta T1_s$ • Deviation in the effective actual width of the internal sub-assembly</p> <p>$\Delta T2_s$ • Deviation in the effective actual width of the external sub-assembly</p>

Functional tolerances

Deviations

radial run-out

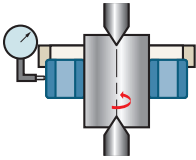

Kia

- Radial run-out of the inner ring on the assembled bearing

Kea

- Radial run-out of the outer ring on the assembled bearing

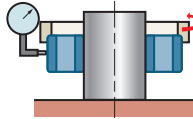

run-out of the reference face

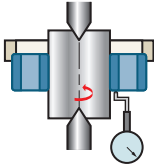

Sd

- Axial run-out of the reference face (or large face if applicable) of the inner ring with respect to the bore (run-out of the face of the inner ring)

SD

- Perpendicularity error of the external surface with respect to the reference face (or large face) of the outer ring (external surface run-out)

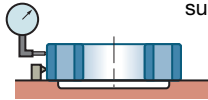

bearing raceway run-out

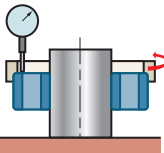

Sea

- Axial run-out of the reference face (or large face) of the outer ring with respect to the bearing raceway, on the assembled bearing (run-out of outer ring raceway)

Sia

- Axial run-out of the reference face (or large face) of the inner ring with respect to the bearing raceway on the assembled bearing (run-out of the inner ring raceway)

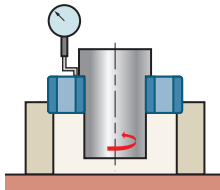

Consult SNR for the method of measurement.

Bearing manufacturing precision *(continued)*

→ Equivalence of bearing precision standards

	ISO tolerance class	AFNOR tolerance class	ABEC tolerance class	DIN tolerance class
Standard Precision	Normal	Normal	1	P0
High Precision	6	6	3	P6
	5	5	5	P5
	4	4	7	P4
	2	2	9	P2

The values given by the various standards for certain characteristics are not rigorously identical.

The tolerance class, when indicated on the bearing, imposes compliance with all the tolerances in the said class.

Nevertheless, certain bearing applications require special tolerances on certain dimensions or characteristics.

To avoid using an excessively expensive high-precision bearing, SNR can supply bearings with reduced tolerances on certain dimensions or characteristics. For example, run-out of inner ring of high-speed bearings for wood-working machine spindles.

Consult SNR.

Bearing tolerances

■ Radial bearings

- Normal tolerance class
- Tolerance class 6
- Tolerance class 5
- Tolerance class 4
- Tolerance class 2

Standard ISO 492

- page 23
- page 24
- page 25
- page 26
- page 27

■ Tapered roller bearings

- Normal tolerance class
- Tolerance class 6X
- Tolerance class 5

Standard ISO 492

- page 28
- page 29
- page 30

■ Thrust bearings

- Normal tolerance class, 6 and 5

Standard ISO 199

- page 31

■ Tapered bores

- Bore with 1:12 and 1:30 taper

Standard ISO 492

- page 32

→ Radial bearings - Normal tolerance classes

With the exception of tapered roller bearings and thrust bearings. Standard ISO 492.

■ Inner ring

Tolerances in micrometers

d mm	Δmp		Vdp ⁽¹⁾			Vdmp	Kia	ΔBs			VBs
			Diameter series					all	normal	modified ⁽¹⁾	
	upper	lower	9	0,1	2,3,4	max	max				max
0,6 ≤ d ≤ 2,5	0	-8	10	8	6	6	10	0	-40	-	12
2,5 < d ≤ 10	0	-8	10	8	6	6	10	0	-120	-250	15
10 < d ≤ 18	0	-8	10	8	6	6	10	0	-120	-250	20
18 < d ≤ 30	0	-10	13	10	8	8	13	0	-120	-250	20
30 < d ≤ 50	0	-12	15	12	9	9	15	0	-120	-250	20
50 < d ≤ 80	0	-15	19	19	11	11	20	0	-150	-380	25
80 < d ≤ 120	0	-20	25	25	15	15	25	0	-200	-380	25
120 < d ≤ 180	0	-25	31	31	19	19	30	0	-250	-500	30
180 < d ≤ 250	0	-30	38	38	23	23	40	0	-300	-500	30
250 < d ≤ 315	0	-35	44	44	26	26	50	0	-350	-500	35
315 < d ≤ 400	0	-40	50	50	30	30	60	0	-400	-630	40
400 < d ≤ 500	0	-45	56	56	34	34	65	0	-450	-	50
500 < d ≤ 630	0	-50	63	63	38	38	70	0	-500	-	60
630 < d ≤ 800	0	-75	-	-	-	-	80	0	-750	-	70
800 < d ≤ 1000	0	-100	-	-	-	-	90	0	-1000	-	80

(1) Relates to the rings of isolated bearings for installation in pairs or per unit.

■ Outer ring

Tolerances in micrometers

D mm	ΔDmp		VDp ⁽¹⁾				VDmp ⁽¹⁾	Kea	ΔCs		VCs
			Open bearings			Shielded bearings			ΔC1s ⁽²⁾		
	upper	lower	9	0,1	2,3,4		2,3,4	max	max	upper	lower
2,5 ≤ D ≤ 6	0	-8	10	8	6	10	6	15			
6 < D ≤ 18	0	-8	10	8	6	10	6	15			
18 < D ≤ 30	0	-9	12	9	7	12	7	15			
30 < D ≤ 50	0	-11	14	11	8	16	8	20			
50 < D ≤ 80	0	-13	16	13	10	20	10	25			
80 < D ≤ 120	0	-15	19	19	11	26	11	35			
120 < D ≤ 150	0	-18	23	23	14	30	14	40			
150 < D ≤ 180	0	-25	31	31	19	38	19	45			
180 < D ≤ 250	0	-30	38	38	23	-	23	50			
250 < D ≤ 315	0	-35	44	44	26	-	26	60			
315 < D ≤ 400	0	-40	50	50	30	-	30	70			
400 < D ≤ 500	0	-45	56	56	34	-	34	80			
500 < D ≤ 630	0	-50	63	63	38	-	38	100			
630 < D ≤ 800	0	-75	94	94	55	-	55	120			
800 < D ≤ 1000	0	-100	125	125	75	-	75	140			

Note: The tolerances on the outside diameter, D1, of the flange on the outer ring are given in standard ISO 492.

(1) Taken before fitting and after removal of the inner or outer snap ring.

(2) Only applies to ball and grooved bearings.

Bearing manufacturing precision (continued)

→ High-precision radial bearings – Tolerance class 6

With the exception of tapered roller bearings and thrust bearings. Standard ISO 492.

■ Inner ring

Tolerances in micrometers

d mm	Δdmp		Vdp			Vdmp	Kia	ΔBs			VBs
			Diameter series					max	max	max	
	9	0,1	2,3,4	all	normal	modified ⁽¹⁾					
	upper	lower	max			max	max	upper	lower	max	
0,6 <d≤ 2,5	0	-7	9	7	5	5	5	0	-40	-	12
2,5 <d≤ 10	0	-7	9	7	5	5	6	0	-120	-250	15
10 <d≤ 18	0	-7	9	7	5	5	7	0	-120	-250	20
18 <d≤ 30	0	-8	10	8	6	6	8	0	-120	-250	20
30 <d≤ 50	0	-10	13	10	8	8	10	0	-120	-250	20
50 <d≤ 80	0	-12	15	15	9	9	10	0	-150	-380	25
80 <d≤ 120	0	-15	19	19	11	11	13	0	-200	-380	25
120 <d≤ 180	0	-18	23	23	14	14	18	0	-250	-500	30
180 <d≤ 250	0	-22	28	28	17	17	20	0	-300	-500	30
250 <d≤ 315	0	-25	31	31	19	19	25	0	-350	-500	35
315 <d≤ 400	0	-30	38	38	23	23	30	0	-400	-630	40
400 <d≤ 500	0	-35	44	44	26	26	35	0	-450	-	45
500 <d≤ 630	0	-40	50	50	30	30	40	0	-500	-	50

(1) Relates to the rings of isolated bearings for installation in pairs or per unit.

■ Outer ring

Tolerances in micrometers

D mm	ΔDmp		VDp ⁽¹⁾				VDmp ⁽¹⁾	Kea	ΔCs		VCs
			Open bearings			Shielded bearings			ΔC1s ⁽²⁾		
	Diameter series			0,1,2,3,4	upper		lower				
	9	0,1	2,3,4			max		max	upper	lower	max
2,5 ≤D≤ 6	0	-7	9	7	5	9	5	8	Identical to ΔBs and VBs of the inner ring of the same bearing		
6 <D≤ 18	0	-7	9	7	5	9	5	8			
18 <D≤ 30	0	-8	10	8	6	10	6	9			
30 <D≤ 50	0	-9	11	9	7	13	7	10			
50 <D≤ 80	0	-11	14	11	8	16	8	13			
80 <D≤ 120	0	-13	16	16	10	20	10	18			
120 <D≤ 150	0	-15	19	19	11	25	11	20			
150 <D≤ 180	0	-18	23	23	14	30	14	23			
180 <D≤ 250	0	-20	25	25	15	-	15	25			
250 <D≤ 315	0	-25	31	31	19	-	19	30			
315 <D≤ 400	0	-28	35	35	21	-	21	35			
400 <D≤ 500	0	-33	41	41	25	-	25	40			
500 <D≤ 630	0	-38	48	48	29	-	29	50			
630 <D≤ 800	0	-45	56	56	34	-	34	60			
800 <D≤ 1000	0	-60	75	75	45	-	45	75			

Note: The tolerances on the outside diameter, D1, of the flange on the outer ring are given in standard ISO 492.

(1) Taken before fitting and after removal of the inner or outer snap ring.

(2) Only applies to ball and grooved bearings.

→ High-precision radial bearings – Tolerance class 5

With the exception of tapered roller bearings and thrust bearings. Standard ISO 492.

■ Inner ring

Tolerances in micrometers

d mm	Δdmp		Vdp		Vdmp	Kia	Sd	Sia ⁽¹⁾	ΔBs			VBs
			Diameter series						all	normal	modified ⁽²⁾	
	upper	lower	9	0,1,2,3,4	max	max	max	max				max
0,6 ≤ d ≤ 2,5	0	-5	5	4	3	4	7	7	0	-40	-250	5
2,5 < d ≤ 10	0	-5	5	4	3	4	7	7	0	-40	-250	5
10 < d ≤ 18	0	-5	5	4	3	4	7	7	0	-80	-250	5
18 < d ≤ 30	0	-6	6	5	3	4	8	8	0	-120	-250	5
30 < d ≤ 50	0	-8	8	6	4	5	8	8	0	-120	-250	5
50 < d ≤ 80	0	-9	9	7	5	5	8	8	0	-150	-250	6
80 < d ≤ 120	0	-10	10	8	5	6	9	9	0	-200	-380	7
120 < d ≤ 180	0	-13	13	10	7	8	10	10	0	-250	-380	8
180 < d ≤ 250	0	-15	15	12	8	10	11	13	0	-300	-500	10
250 < d ≤ 315	0	-18	18	14	9	13	13	15	0	-350	-500	13
315 < d ≤ 400	0	-23	23	18	12	15	15	20	0	-400	-630	15

(1) Only applies to ball and grooved bearings

(2) Relates to the rings of isolated bearings for installation in pairs or per unit.

■ Outer ring

Tolerances in micrometers

D mm	ΔDmp		VDp		VDmp	Kea	SD ⁽¹⁾ SD1 ⁽²⁾	Sea ⁽¹⁾⁽²⁾	Sea1 ⁽²⁾	ΔCs ΔC1s ⁽²⁾		VCs VC1s ⁽²⁾
			Diameter series							all	normal	
	upper	lower	9	0,1,2,3,4	max	max	max	max	max			max
2,5 ≤ D ≤ 6	0	-5	5	4	3	5	8	8	11	Identical to ΔBs of the inner ring of the same bearing	5	
6 < D ≤ 18	0	-5	5	4	3	5	8	8	11		5	
18 < D ≤ 30	0	-5	6	5	3	6	8	8	11		5	
30 < D ≤ 50	0	-7	7	5	4	7	8	8	11		5	
50 < D ≤ 80	0	-9	9	7	5	8	8	10	14		6	
80 < D ≤ 120	0	-10	10	8	5	10	9	11	16		8	
120 < D ≤ 150	0	-11	11	8	6	11	10	13	18		8	
150 < D ≤ 180	0	-13	13	10	7	13	10	14	20		8	
180 < D ≤ 250	0	-15	15	11	8	15	11	15	21		10	
250 < D ≤ 315	0	-18	18	14	9	18	13	18	25		11	
315 < D ≤ 400	0	-20	20	15	10	20	13	20	28		13	
400 < D ≤ 500	0	-23	23	17	12	23	15	23	33		15	
500 < D ≤ 630	0	-28	28	21	14	25	18	25	35		18	
630 < D ≤ 800	0	-35	35	26	18	30	20	30	42		20	

Note: The tolerances on the outside diameter, D1, of the flange on the outer ring are given in standard ISO 492.

(1) Does not apply to bearings with a flange-type outer ring.

(2) Only applies to ball and grooved bearings.

Bearing manufacturing precision (continued)

→ High-precision radial bearings – Tolerance class 4

With the exception of tapered roller bearings and thrust bearings. Standard ISO 492.

■ Inner ring

Tolerances in micrometers

d mm	Δdmp		Δds ⁽¹⁾		Vdp		Vdmp	Kia	Sd	Sia ⁽²⁾	ΔBs			VBs
					9	0,1,2,3,4					all	normal	modified ⁽²⁾	
	upper	lower	upper	lower			max	max	max	max				max
0,6 <d≤ 2,5	0	-4	0	-4	4	3	2	2,5	3	3	0	-40	-250	2,5
2,5 <d≤ 10	0	-4	0	-4	4	3	2	2,5	3	3	0	-40	-250	2,5
10 <d≤ 18	0	-4	0	-4	4	3	2	2,5	3	3	0	-80	-250	2,5
18 <d≤ 30	0	-5	0	-5	5	4	2,5	3	4	4	0	-120	-250	2,5
30 <d≤ 50	0	-6	0	-6	6	5	3	4	4	4	0	-120	-250	3
50 <d≤ 80	0	-7	0	-7	7	5	3,5	4	5	5	0	-150	-250	4
80 <d≤ 120	0	-8	0	-8	8	6	4	5	5	5	0	-200	-380	4
120 <d≤ 180	0	-10	0	-10	10	8	5	6	6	7	0	-250	-380	5
180 <d≤ 250	0	-12	0	-12	12	9	6	8	7	8	0	-300	-500	6

(1) These differences apply to diameter series 0, 1, 2, 3 and 4 only.

(2) Only applies to ball and grooved bearings

(3) Relates to the rings of isolated bearings for installation in pairs or per unit.

■ Outer ring

Tolerances in micrometers

D mm	ΔDmp		ΔDs ⁽¹⁾		VDp		VDmp	Kea	Sd ⁽²⁾ Sd1 ⁽³⁾	Sea ⁽²⁾⁽³⁾	Sea1 ⁽³⁾	ΔCs ΔC1s ⁽³⁾		VCs VC1s ⁽³⁾
					9	0,1,2,3,4						upper	lower	
	upper	lower	upper	lower			max	max	max	max	max			max
2,5 ≤D≤ 6	0	-4	0	-4	4	3	2	3	4	5	7	Identical to ΔBs of the inner ring of the same bearing	2,5	
6 <D≤ 18	0	-4	0	-4	4	3	2	3	4	5	7		2,5	
18 <D≤ 30	0	-5	0	-5	5	4	2,5	4	4	5	7		2,5	
30 <D≤ 50	0	-6	0	-6	6	5	3	5	4	5	7		2,5	
50 <D≤ 80	0	-7	0	-7	7	5	3,5	5	4	5	7		3	
80 <D≤ 120	0	-8	0	-8	8	6	4	6	5	6	8		4	
120 <D≤ 150	0	-9	0	-9	9	7	5	7	5	7	10		5	
150 <D≤ 180	0	-10	0	-10	10	8	5	8	5	8	11		5	
180 <D≤ 250	0	-11	0	-11	11	8	6	10	7	10	14		7	
250 <D≤ 315	0	-13	0	-13	13	10	7	11	8	10	14		7	
315 <D≤ 400	0	-15	0	-15	15	11	8	13	10	13	18	8		

Note: The tolerances on the outside diameter, D1, of the flange on the outer ring are given in standard ISO 492.

(1) These differences apply to diameter series 0, 1, 2, 3 and 4 only.

(2) Only applies to ball and grooved bearings

(3) Relates to the rings of isolated bearings for installation in pairs or per unit.

→ High-precision radial bearings – Tolerance class 2

With the exception of tapered roller bearings and thrust bearings. Standard ISO 492.

■ Inner ring

Tolerances in micrometers

d mm	Δd_{mp}		Δd_s		$V_{dp}^{(1)}$	V_{dmp}	K_{ia}	S_d	$S_{ia}^{(2)}$	ΔB_s			V_Bs
	upper	lower	upper	lower	max	max	max	max	max	all	normal	modified ⁽³⁾	max
										upper	lower		
0,6 $d \leq 2,5$	0	-2,5	0	-2,5	2,5	1,5	1,5	1,5	1,5	0	-40	-250	1,5
2,5 $d \leq 10$	0	-2,5	0	-2,5	2,5	1,5	1,5	1,5	1,5	0	-40	-250	1,5
10 $d \leq 18$	0	-2,5	0	-2,5	2,5	1,5	1,5	1,5	1,5	0	-80	-250	1,5
18 $d \leq 30$	0	-2,5	0	-2,5	2,5	1,5	2,5	1,5	2,5	0	-120	-250	1,5
30 $d \leq 50$	0	-2,5	0	-2,5	2,5	1,5	2,5	1,5	2,5	0	-120	-250	1,5
50 $d \leq 80$	0	-4	0	-4	4	2	2,5	1,5	2,5	0	-150	-250	1,5
80 $d \leq 120$	0	-5	0	-5	5	2,5	2,5	2,5	2,5	0	-200	-380	2,5
120 $d \leq 150$	0	-7	0	-7	7	3,5	2,5	2,5	2,5	0	-250	-380	2,5
150 $d \leq 180$	0	-7	0	-7	7	3,5	5	4	5	0	-250	-380	4
180 $d \leq 250$	0	-8	0	-8	8	4	5	5	5	0	-300	-500	5

(1) These differences apply to diameter series 0, 1, 2, 3 and 4 only.

(2) Only applies to ball and grooved bearings

(3) Relates to the rings of isolated bearings for installation in pairs or per unit.

■ Outer ring

Tolerances in micrometers

D mm	ΔD_{mp}		ΔD_s		$V_{Dp}^{(1)}$	V_{Dp}	K_{ea}	$S_d^{(2)}$	$S_{d1}^{(3)}$	$S_{ia}^{(2)(3)}$	$S_{ia1}^{(3)}$	ΔC_s $\Delta C_{1s}^{(3)}$		V_Cs $V_{C1s}^{(3)}$
	upper	lower	upper	lower	max	max	max	max	max	max	max	upper	lower	max
2,5 $D \leq 6$	0	-2,5	0	-2,5	2,5	1,5	1,5	1,5	1,5	3	3	Identical to ΔB_s of the inner ring of the same bearing	1,5	
6 $D \leq 18$	0	-2,5	0	-2,5	2,5	1,5	1,5	1,5	1,5	3	3		1,5	
18 $D \leq 30$	0	-4	0	-4	4	2	2,5	1,5	2,5	4	4		1,5	
30 $D \leq 50$	0	-4	0	-4	4	2	2,5	1,5	2,5	4	4		1,5	
50 $D \leq 80$	0	-4	0	-4	4	2	4	1,5	4	6	6		2,5	
80 $D \leq 120$	0	-5	0	-5	5	2,5	5	2,5	5	7	7		2,5	
120 $D \leq 150$	0	-5	0	-5	5	2,5	5	2,5	5	7	7	2,5		
150 $D \leq 180$	0	-7	0	-7	7	3,5	5	2,5	5	7	7	2,5		
180 $D \leq 250$	0	-8	0	-8	8	4	7	4	7	10	10	4		
250 $D \leq 315$	0	-8	0	-8	8	4	7	5	7	10	10	5		
315 $D \leq 400$	0	-10	0	-10	10	5	8	7	8	11	11	7		

Note: The tolerances on the outside diameter, D1, of the flange on the outer ring are given in standard ISO 492.

(1) These differences apply to diameter series 0, 1, 2, 3 and 4 only.

(2) Only applies to ball and grooved bearings

(3) Relates to the rings of isolated bearings for installation in pairs or per unit.

Bearing manufacturing precision *(continued)*

→ Tapered roller bearings - Normal tolerance class

■ Diameter and radial run-out - Inner ring

Tolerances in micrometers

d mm	Δd_{mp}		V _d p	V _d mp	K _{ia}
	upper	lower	max	max	max
10 $\leq d \leq$ 18	0	-12	12	9	15
18 $< d \leq$ 30	0	-12	12	9	18
30 $< d \leq$ 50	0	-12	12	9	20
50 $< d \leq$ 80	0	-15	15	11	25
80 $< d \leq$ 120	0	-20	20	15	30
120 $< d \leq$ 180	0	-25	25	19	35
180 $< d \leq$ 250	0	-30	30	23	50
250 $< d \leq$ 315	0	-35	35	26	60
315 $< d \leq$ 400	0	-40	40	30	70

■ Diameter and radial run-out - Outer ring

Tolerances in micrometers

D mm	ΔD_{mp}		V _D p	V _D mp	K _{ea}
	upper	lower	max	max	max
18 $\leq D \leq$ 30	0	-12	12	9	18
30 $< D \leq$ 50	0	-14	14	11	20
50 $< D \leq$ 80	0	-16	16	12	25
80 $< D \leq$ 120	0	-18	18	14	35
120 $< D \leq$ 150	0	-20	20	15	40
150 $< D \leq$ 180	0	-25	25	19	45
180 $< D \leq$ 250	0	-30	30	23	50
250 $< D \leq$ 315	0	-35	35	26	60
315 $< D \leq$ 400	0	-40	40	30	70
400 $< D \leq$ 500	0	-45	45	34	80
500 $< D \leq$ 630	0	-50	50	38	100

Note: The tolerances on the outside diameter, D₁, of the flange on the outer ring are given in standard ISO 492.

■ Width - Inner and outer rings, single-row bearings and single-row sub-assemblies

Tolerances in micrometers

d mm	ΔBs		ΔCs		ΔTs		ΔT1s		ΔT2s	
	upper	lower	upper	lower	upper	lower	upper	lower	upper	lower
10 ≤d≤ 18	0	-120	0	-120	+200	0	+100	0	+100	0
18 <d≤ 30	0	-120	0	-120	+200	0	+100	0	+100	0
30 <d≤ 50	0	-120	0	-120	+200	0	+100	0	+100	0
50 <d≤ 80	0	-150	0	-150	+200	0	+100	0	+100	0
80 <d≤ 120	0	-200	0	-200	+200	-200	+100	-100	+100	-100
120 <d≤ 180	0	-250	0	-250	+350	-250	+150	-150	+200	-100
180 <d≤ 250	0	-300	0	-300	+350	-250	+150	-150	+200	-100
250 <d≤ 315	0	-350	0	-350	+350	-250	+150	-150	+200	-100
315 <d≤ 400	0	-400	0	-400	+400	-400	+200	-200	+200	-200

➔ **High-precision tapered roller bearings – Tolerance class 6X**

The diameter and radial run-out tolerances of inner rings (cones) and outer rings (cups) in this tolerance class are the same as those given in page 28 for the normal class. The width tolerances are given below.

■ Width - Inner and outer rings, single-row bearings and single-row sub-assemblies

Tolerances in micrometers

d mm	ΔBs		ΔCs		ΔTs		ΔT1s		ΔT2s	
	upper	lower	upper	lower	upper	lower	upper	lower	upper	lower
10 ≤d≤ 18	0	-50	0	-100	+100	0	+50	0	+50	0
18 <d≤ 30	0	-50	0	-100	+100	0	+50	0	+50	0
30 <d≤ 50	0	-50	0	-100	+100	0	+50	0	+50	0
50 <d≤ 80	0	-50	0	-100	+100	0	+50	0	+50	0
80 <d≤ 120	0	-50	0	-100	+100	0	+50	0	+50	0
120 <d≤ 180	0	-50	0	-100	+150	0	+50	0	+100	0
180 <d≤ 250	0	-50	0	-100	+150	0	+50	0	+100	0
250 <d≤ 315	0	-50	0	-100	+200	0	+100	0	+100	0
315 <d≤ 400	0	-50	0	-100	+200	0	+100	0	+100	0

Bearing manufacturing precision *(continued)*

➔ High-precision tapered roller bearings - Tolerance class 5

■ Inner ring (cone) and width of single-row bearing

Tolerances in micrometers

d mm	Δdmp		Vdp	Vdmp	Kia	Sd	ΔBs		ΔTs	
	upper	lower	max	max	max	max	upper	lower	upper	lower
10 ≤d≤ 18	0	-7	5	5	5	7	0	-200	+200	-200
18 <d≤ 30	0	-8	6	5	5	8	0	-200	+200	-200
30 <d≤ 50	0	-10	8	5	6	8	0	-240	+200	-200
50 <d≤ 80	0	-12	9	6	7	8	0	-300	+200	-200
80 <d≤ 120	0	-15	11	8	8	9	0	-400	+200	-200
120 <d≤ 180	0	-18	14	9	11	10	0	-500	+350	-250
180 <d≤ 250	0	-22	17	11	13	11	0	-600	+350	-250

■ Outer ring (cup)

Tolerances in micrometers

D mm	Δdmp		Vdp	Vdmp	Kea	Sd ⁽¹⁾ , SD1	ΔTs	
	upper	lower	max	max	max	max	upper	lower
18 <D≤ 30	0	-8	6	5	6	8	Identical to ΔBs of the inner ring of the same bearing	
30 <D≤ 50	0	-9	7	5	7	8		
50 <D≤ 80	0	-11	8	6	8	8		
80 <D≤ 120	0	-13	10	7	10	9		
120 <D≤ 150	0	-15	11	8	11	10		
150 <D≤ 180	0	-18	14	9	13	10		
180 <D≤ 250	0	-20	15	10	15	11		
250 <D≤ 315	0	-25	19	13	18	13		
315 <D≤ 400	0	-28	22	14	20	13		

Note: The tolerances on the outside diameter, D1, of the flange on the outer ring are given in standard ISO 492.

(1) Does not apply to bearings with a flanged outer ring.

→ **Ball thrust bearings - Normal tolerance class**

■ **Standard ISO 199**

References

d	Nominal bore diameter of the shaft ring of a single-direction thrust bearing	
Δdmp	Deviation in the mean bore diameter of the shaft ring of a single-direction thrust bearing, in an isolated plane	
Vdp	Variation in the bore diameter of the shaft ring of a single-direction thrust bearing, in an isolated radial plane	
D	Nominal outside diameter of the housing ring	
ΔDmp	Deviation in the mean outside diameter of the housing ring in an isolated plane	
VDp	Variation in the outside diameter of the housing ring in an isolated radial plane	
Si	Variation in thickness between the bearing raceway and the contact face of the shaft ring	
Se	Variation in thickness between the bearing raceway and the contact face of the housing ring	
ΔTs	Variation in total height	

■ **Shaft ring and height of thrust bearing**

Tolerances in micrometers

d mm		Δdmp		Vdp	Si	ΔTs	
>	≤	upper	lower	max	max	upper	lower
–	18	0	-8	6	10	+20	-250
18	30	0	-10	8	10	+20	-250
30	50	0	-12	9	10	+20	-250
50	80	0	-15	11	10	+20	-300
80	120	0	-20	15	15	+25	-300
120	180	0	-25	19	15	+25	-400
180	250	0	-30	23	20	+30	-400
250	315	0	-35	26	25	+40	-400
315	400	0	-40	30	30	+40	-500
400	500	0	-45	34	30	+50	-500

Bearing manufacturing precision (continued)

Housing ring

Tolerances in micrometers

D mm		ΔD_{mp}		VDp	Se
>	\leq	upper	lower	max	max
10	18	0	-11	8	Identical to Si of the shaft ring of the same type
18	30	0	-13	10	
30	50	0	-16	12	
50	80	0	-19	14	
80	120	0	-22	17	
120	180	0	-25	19	
180	250	0	-30	23	
250	315	0	-35	26	
315	400	0	-40	30	
400	500	0	-45	34	
500	630	0	-50	38	

→ Tapered bores: 1:12 and 1:30 taper

Standard ISO 492

Nominal half-angle at apex of cone:

$$1/12 : \alpha = 2^\circ 23' 9.4'' = 2.38594^\circ = 0.041643 \text{ rad}$$

$$1/30 : \alpha = 0^\circ 57' 17.4'' = 0.95484^\circ = 0.016665 \text{ rad}$$

Nominal diameter at the largest theoretical width of the bore:

$$1/12 : d' = d + B / 12$$

$$1/30 : d' = d + B / 30$$

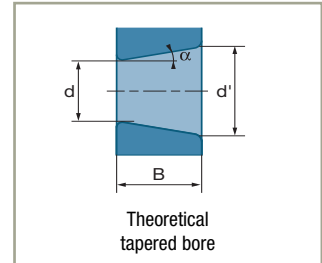

The tolerances on a tapered bore comprise:

- a tolerance on the mean diameter, given by the limits of the actual deviation of the mean diameter at the smallest theoretical width of the bore Δd_{mp} ,
- a taper tolerance, given by the limits of the deviation between the mean diameter deviations at each end of the bore $\Delta' d'_{mp} - \Delta d_{mp}$,
- a tolerance on the diameter variation Vdp given by a maximum value applicable in any radial plane of the bore

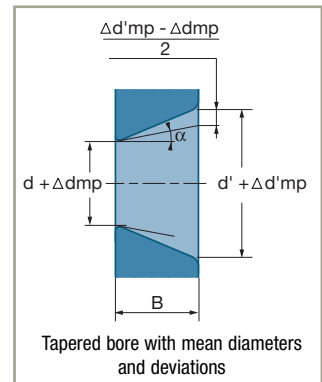

■ Tapered bore, 1:12 taper

Tolerances in micrometers

d mm	Δd_{mp}		$\Delta d'_{mp} - \Delta d_{mp}$		$V_{dp}^{(1)(2)}$
	upper	lower	upper	lower	max
$d \leq 10$	22	0	15	0	9
$10 < d \leq 18$	27	0	18	0	11
$18 < d \leq 30$	33	0	21	0	13
$30 < d \leq 50$	39	0	25	0	16
$50 < d \leq 80$	46	0	30	0	19
$80 < d \leq 120$	54	0	35	0	22
$120 < d \leq 180$	63	0	40	0	40
$180 < d \leq 250$	72	0	46	0	46
$250 < d \leq 315$	81	0	52	0	52
$315 < d \leq 400$	89	0	57	0	57
$400 < d \leq 500$	97	0	63	0	63
$500 < d \leq 630$	110	0	70	0	70
$630 < d \leq 800$	125	0	80	0	–
$800 < d \leq 1000$	140	0	90	0	–

(1) Applies to any isolated radial plane of the bore.

(2) Does not apply to diameter series 7 and 8.

■ Tapered bore, 1:30 taper

Tolerances in micrometers

d mm	Δd_{mp}		$\Delta d'_{mp} - \Delta d_{mp}$		$V_{dp}^{(1)(2)}$
	upper	lower	upper	lower	max
$50 < d \leq 80$	15	0	30	0	19
$80 < d \leq 120$	20	0	35	0	22
$120 < d \leq 180$	25	0	40	0	40
$180 < d \leq 250$	30	0	46	0	46
$250 < d \leq 315$	35	0	52	0	52
$315 < d \leq 400$	40	0	57	0	57
$400 < d \leq 500$	45	0	63	0	63
$500 < d \leq 630$	50	0	70	0	70

(1) Applies to any isolated radial plane of the bore.

(2) Does not apply to diameter series 7 and 8.

Bearings initial radial internal clearance

Radial clearance of radial contact bearings. Definition

The internal radial clearance is the load-free displacement of one ring with respect to the other in the radial direction.

Radial contact bearings to run correctly must have a slight radial clearance.

Radial contact bearings have a built in internal clearance. When the bearing is fitted, a residual clearance must remain.

This radial clearance leads to an axial clearance (except in the case of cylindrical roller bearings).

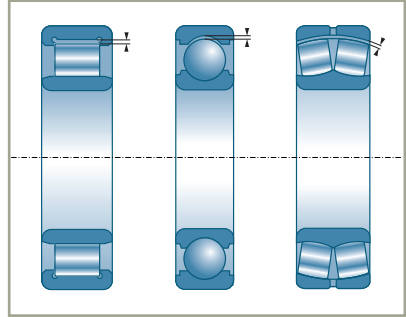

Internal radial clearance groups

The clearance tolerances of groups are standard (ISO 5753 standard).

The internal clearance group is chosen according to the application specifications and the residual clearance calculation.

Radial clearance		Bearing designation	Other manufacturers
Type	Group	SNR suffix	
Normal clearance	N		Suitable for low or moderate loads, normal interference fit of only one of the two rings, normal temperatures.
Increased clearance	3	C3	Clearance frequently used in the following cases: - tight interference fit of one ring or slight on both rings - possible misalignment, bending of shaft - to increase the contact angle of highly-loaded radial contact ball bearings - high temperatures Clearance groups 4 and 5 are used in the above cases when group 3 is insufficient.
	4	C4	
	5	C5	
Reduced clearance	2	C2	This clearance group is used (rarely) when very good guidance with reduced clearance is required, and in applications with alternating loads and high impact levels. The use of this clearance group is highly particular because its aim is usually to cancel the bearing operating clearance. The study of the assembly (alignment), fits and operating conditions (temperature, speed) must be carried out with particular care. Consult SNR.

Axial clearance of angular contact bearings

Recommended axial clearance

By construction, single-row angular contact ball bearings or tapered roller bearings have no internal clearance.

The bearing clearance is zero when its inner ring, rolling elements and outer ring are in contact without any load applied.

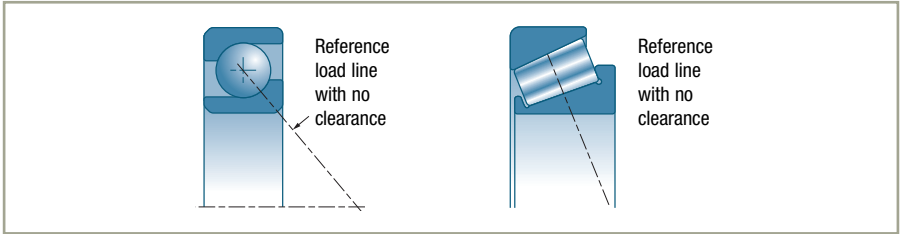

When the bearing is mounted it can be given a clearance or a preload with respect to this reference position.

The figure opposite shows the positions of the components when there is an axial clearance.

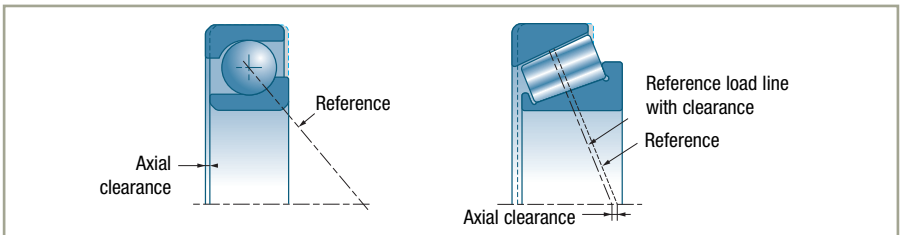

■ Magnitude of the axial clearance of an assembly in operation

The value of the initial clearance on fitting must take into account the operating conditions.

The relation between the axial clearance and radial clearance of a two-bearing assembly is indicated for each type of bearing in chapter corresponding to each family.

$d = \text{bearing bore}$	$J_a = \text{axial clearance}$
$d < 20 \text{ mm}$	$J_a = 0.03 \text{ up to } 0.08 \text{ mm}$
$20 < d \leq 80 \text{ mm}$	$J_a = 0.05 \text{ up to } 0.15 \text{ mm}$
$80 < d \leq 120 \text{ mm}$	$J_a = 0.05 \text{ up to } 0.25 \text{ mm}$
$d > 120 \text{ mm}$	$J_a = 0.10 \text{ up to } 0.30 \text{ mm}$

Bearing technology

Bearing characteristics	38
■ Bearing design	38
■ Materials and surface treatments	39
<i>Knowledge of materials and monitoring of their quality</i>	39
<i>Materials and surface treatments</i>	39
<i>Heat treatment</i>	40
■ Bearing manufacture	42
<i>Shaping the bearing rings</i>	42
<i>The bearing finish</i>	42
<i>Standard manufacturing process</i>	43
Bearing component variants	44
■ Inner ring	44
<i>Tapered bore</i>	44
<i>Special corners</i>	45
■ Definitions	46
■ Other ring variants	48
■ Cage	49
<i>Materials</i>	49
<i>Centering</i>	50
<i>Choice of a special cage</i>	50
Shielding and sealing	52
■ Shielding and sealing devices external to the bearing	53
■ Other types of seals	54

Bearing characteristics

Bearing design

The continuous improvement in the performance of SNR bearings and their service life relies upon constant technological progress in three areas: design, materials and manufacture.

■ Standard bearing

The aim of the design is to determine the internal geometry of the bearing while adhering to a standard envelope. The bearing must meet the largest possible number of applications while achieving the best cost/performance compromise.

The optimization effort focuses on the bearing components: rolling elements (number, dimensions, profile), bearing raceways (profile), cage (material, design), and the seals, taking into account:

- the mechanical strength of the materials
- the manufacturing means
- the cost

■ Special bearing

When it is technically necessary and economically possible, the SNR bearing can provide a more comprehensive rotation function, either through a specially developed capability, or by integrating a set of functions associated with the rotation function: attachment, shielding, lubrication, power transmission, measurement, etc.

The adaptation of these bearings to the application brings substantial gains through technical and industrial optimization. It allows, among other things, an original design to be protected and more generally to increase the performance of your products. We advise you to contact your SNR representative to investigate this highly effective approach.

Materials and surface treatments

→ Knowledge of materials and monitoring of their quality

SNR carries out in-depth research into the endurance of steels in collaboration with steel manufacturers. For each grade of steel we have defined extremely precise and stringent specifications that concern the following points:

- the method of steel production
- the chemical composition
- the hardness, quenching hardenability
- the macrostructure and macrographic soundness
- the microstructure and micro-cleanliness
- the endurance
- the product presentation
- the reception and inspection conditions

The verification of the material is performed by metallographic and spectrographic inspection, completed by bench tests.

This section details the most currently used materials and surface treatments. Your SNR contacts are at your disposal to study with you the solutions to meet your specifications.

→ Materials and surface treatments

■ Applications standard

Requirements	Proposals														
<ul style="list-style-type: none"> ▶ Excellent resistance to fatigue and wear. ▶ Can achieve homogenous hardness throughout. 	<ul style="list-style-type: none"> ▶ 100Cr6 (AFNOR) high-carbon chromium steel This very commonly used steel displays many advantages: cleanliness (absence of inclusions), quenchantability without carburization, heat treatment method flexibility. Our continuous quality monitoring of materials has enabled us to substantially increase the endurance of this type of steel. 														
	<table style="width: 100%; border-collapse: collapse;"> <tr> <td style="width: 60%; vertical-align: top;">▶ Chemical composition</td> <td style="vertical-align: top;"> <table style="width: 100%; border-collapse: collapse;"> <tr> <td style="width: 10%;"></td> <td style="width: 10%;">C</td> <td style="width: 80%;">from 0.98 to 1.10 %</td> </tr> <tr> <td></td> <td>Si</td> <td>from 0.15 to 0.35 %</td> </tr> <tr> <td></td> <td>Mn</td> <td>from 0.25 to 0.45 %</td> </tr> <tr> <td></td> <td>Cr</td> <td>from 1.30 to 1.60 %</td> </tr> </table> </td> </tr> </table>	▶ Chemical composition	<table style="width: 100%; border-collapse: collapse;"> <tr> <td style="width: 10%;"></td> <td style="width: 10%;">C</td> <td style="width: 80%;">from 0.98 to 1.10 %</td> </tr> <tr> <td></td> <td>Si</td> <td>from 0.15 to 0.35 %</td> </tr> <tr> <td></td> <td>Mn</td> <td>from 0.25 to 0.45 %</td> </tr> <tr> <td></td> <td>Cr</td> <td>from 1.30 to 1.60 %</td> </tr> </table>		C	from 0.98 to 1.10 %		Si	from 0.15 to 0.35 %		Mn	from 0.25 to 0.45 %		Cr	from 1.30 to 1.60 %
	▶ Chemical composition	<table style="width: 100%; border-collapse: collapse;"> <tr> <td style="width: 10%;"></td> <td style="width: 10%;">C</td> <td style="width: 80%;">from 0.98 to 1.10 %</td> </tr> <tr> <td></td> <td>Si</td> <td>from 0.15 to 0.35 %</td> </tr> <tr> <td></td> <td>Mn</td> <td>from 0.25 to 0.45 %</td> </tr> <tr> <td></td> <td>Cr</td> <td>from 1.30 to 1.60 %</td> </tr> </table>		C	from 0.98 to 1.10 %		Si	from 0.15 to 0.35 %		Mn	from 0.25 to 0.45 %		Cr	from 1.30 to 1.60 %	
		C	from 0.98 to 1.10 %												
	Si	from 0.15 to 0.35 %													
	Mn	from 0.25 to 0.45 %													
	Cr	from 1.30 to 1.60 %													
<table style="width: 100%; border-collapse: collapse;"> <tr> <td style="width: 40%; vertical-align: top;">▶ Mechanical characteristics</td> <td style="vertical-align: top;"> <table style="width: 100%; border-collapse: collapse;"> <tr> <td style="width: 30%;">Coefficient of expansion</td> <td style="width: 70%;">: C1=12 x10⁻⁶ mm/mm/°C</td> </tr> <tr> <td>Modulus of elasticity</td> <td>: E = 205 000 N/mm²</td> </tr> <tr> <td>Poisson ratio</td> <td>: η = 0.3</td> </tr> </table> </td> </tr> </table>	▶ Mechanical characteristics	<table style="width: 100%; border-collapse: collapse;"> <tr> <td style="width: 30%;">Coefficient of expansion</td> <td style="width: 70%;">: C1=12 x10⁻⁶ mm/mm/°C</td> </tr> <tr> <td>Modulus of elasticity</td> <td>: E = 205 000 N/mm²</td> </tr> <tr> <td>Poisson ratio</td> <td>: η = 0.3</td> </tr> </table>	Coefficient of expansion	: C1=12 x10 ⁻⁶ mm/mm/°C	Modulus of elasticity	: E = 205 000 N/mm ²	Poisson ratio	: η = 0.3							
▶ Mechanical characteristics	<table style="width: 100%; border-collapse: collapse;"> <tr> <td style="width: 30%;">Coefficient of expansion</td> <td style="width: 70%;">: C1=12 x10⁻⁶ mm/mm/°C</td> </tr> <tr> <td>Modulus of elasticity</td> <td>: E = 205 000 N/mm²</td> </tr> <tr> <td>Poisson ratio</td> <td>: η = 0.3</td> </tr> </table>	Coefficient of expansion	: C1=12 x10 ⁻⁶ mm/mm/°C	Modulus of elasticity	: E = 205 000 N/mm ²	Poisson ratio	: η = 0.3								
Coefficient of expansion	: C1=12 x10 ⁻⁶ mm/mm/°C														
Modulus of elasticity	: E = 205 000 N/mm ²														
Poisson ratio	: η = 0.3														
<ul style="list-style-type: none"> ▶ 100 Cr6 vacuum re-melted when a gain in performance in a given envelope is absolutely necessary. ▶ XC68 for bearings produced from steel strip. 															

Bearing characteristics *(continued)*

■ Special applications

Requirements	Proposals
<ul style="list-style-type: none"> ▶ High resistance to fatigue and wear. ▶ High impact strength at core. 	<ul style="list-style-type: none"> ▶ 100Cr6 steel with localized hardening of the bearing raceways and working surfaces (e.g. contact faces), while the core of the part remains in the initial metallurgical condition. ▶ Case-hardening steels.
<ul style="list-style-type: none"> ▶ Resistant to high temperatures. 	<ul style="list-style-type: none"> ▶ 100Cr6 steel with stabilization heat treatment. <p>For bearings made in limited quantities:</p> <ul style="list-style-type: none"> ▶ E80DCV40 (AFNOR) or M50 (AISI) "tool" steel, produced and cast in vacuum when identical hardness at core and surface is necessary; ▶ High-temperature case-hardening steels; ▶ Nitriding steels if the bearings are subject to moderate loads.
<ul style="list-style-type: none"> ▶ Improvement in the wear resistance of the bearing external surfaces. 	<ul style="list-style-type: none"> ▶ Anti-wear surface treatments such as phosphatizing, hard chrome plating, black oxidizing, or others, depending on specifications.
<ul style="list-style-type: none"> ▶ Improvement in corrosion resistance. 	<ul style="list-style-type: none"> ▶ Surface treatments such as electrolytic zinc or others depending on specifications. ▶ Stainless steels.
<ul style="list-style-type: none"> ▶ Improvement in fretting corrosion resistance between the shaft or housing and the bearing. 	<ul style="list-style-type: none"> ▶ Surface treatments such as copper or hard chrome plating on the external surfaces of the bearing.
<ul style="list-style-type: none"> ▶ Lubrication in very low quantities or lubrication by the surrounding environment (petrol, diesel, etc.). 	<ul style="list-style-type: none"> ▶ Use of ceramic balls. ▶ Self-lubricating surface treatments such as silver + molybdenum bisulphide or others for lightly loaded bearings.
<ul style="list-style-type: none"> ▶ Improvement in contamination resistance. 	<ul style="list-style-type: none"> ▶ The collaboration between SNR and the steel manufacturers came up with the development of a bearing steel that is less sensitive to contamination. This steel, which has a special chemical composition and microstructure, requires an appropriate heat treatment. This new material reconciles high surface hardness to resist wear with matrix ductility which reduces the risk of cracking, while maintaining good dimensional stability.

➔ Heat treatment

The principle of bearing steel heat treatment is to give a martensitic structure to get:

- the required hardness (62 HRc approx.),
- the fatigue resistance,
- and the dimensional stability,

necessary to cover the majority of applications.

It requires a pre-hardening austenitic phase at high temperature above the transformation point.

Types of treatments

SNR has defined several types of standard hardening of 100 Cr6 steel adapted to the requirements of the application.

For example:

Deep martensitic hardening which, by means of judiciously chosen tempering operations, gives perfectly controlled compromises between the ability to withstand Hertz stresses and dimensional stability, and therefore maintaining the geometric precision of the bearings under the most general service conditions.

Surface hardening of the raceways and working surfaces (e.g. contact faces), while the core of the part remains in the initial metallurgical condition.

Deep bainitic hardening which gives a good hardness / toughness compromise in the mass and on the raceways.

Dimensional stability of the steel and influence on the bearing clearance

Hardened martensitic steel always contains a percentage of residual austenite that limits its use to a temperature range of approximately -20°C (-4°F) to $+150^{\circ}\text{C}$ (302°F).

At low temperature

hardening continues and the residual austenite (γ) transforms into secondary martensite (α') and increases the specific volume of the steel.

At high temperature

the transformation of residual austenite ($\gamma \rightarrow \alpha$) brings an increase in the specific volume of the steel (1)

the depletion of martensite through the release of carbon (ϵ) brings a reduction in the specific volume of the steel (2)

These two irreversible phenomena only compensate for one another to a very

limited extent. The bearing undergoes a dimensional variation whose amplitude and speed depend on the holding time at its operating temperature, which leads to a modification in the shaft-bearing and bearing-housing fits and therefore the operating clearance.

Beyond the normal temperature of $+150^{\circ}\text{C}$ ($+302^{\circ}\text{F}$), the dimensional variation of the steel is no longer considered negligible, and bearings used will have to undergo a special stabilization heat treatment that restores dimensional variations to a level compatible with the applications.

→ Consult SNR.

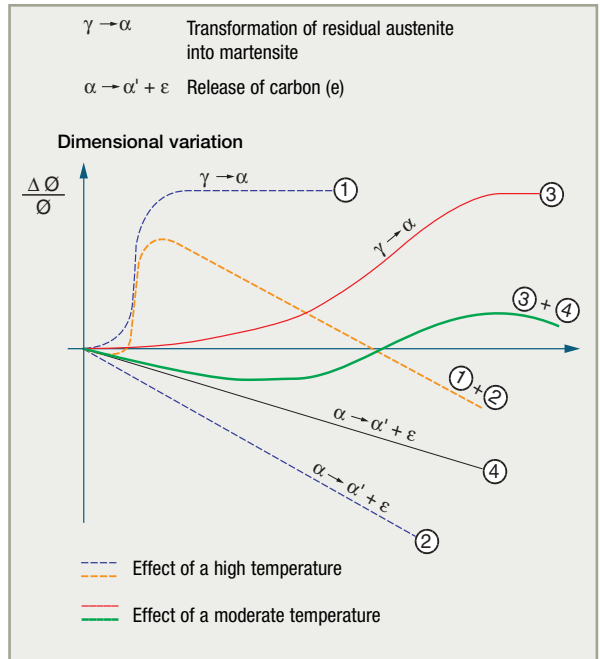

Bearing characteristics *(continued)*

Bearing manufacture

SNR has developed an efficient production quality insurance system subtended by operator control and continuous process monitoring (SPC). This system ensures optimum quality of our products over time by mastering all the component process (means, methods, labor, environment and material).

→ Shaping the bearing rings

The bearing rings are shaped by:

- turning,
- deformation (drop forging, rolling, drawing).

The deformation of the metal produces a fiber orientation that is parallel to the raceway, increasing fatigue strength and therefore endurance. The development of deformation techniques is associated with the best cost-performance compromise.



→ The bearing finish

The finishing operations determine the surface quality of the contacting elements, which is fundamental for stress resistance and lubrication.

■ Quality is monitored at three levels:

- ▶ **Geometry:** shapes, micro-geometry of contact surfaces (curves, profiles, etc.)

With roller bearings, the distribution of forces on the roller-ring interface is not uniform and depends upon:

- the applied loads,
- the misalignments imposed on the bearing,
- the contacting profiles.

The production of optimized profiles for roller bearings:

- improves load distribution on the roller contact line
- avoids having excess stresses at the roller edges.



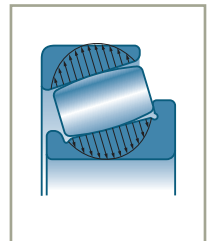
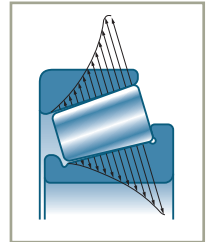

With ball bearings, adapting the race curvatures to the operating conditions enables the bearing geometry to be optimized, bringing a reduction in the friction torque and an increase in service life.

- ▶ **Surface roughness**

- ▶ **Metallurgical condition:** the machining method has to take in account the surface metallurgical qualities

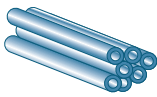

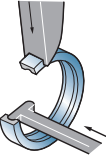
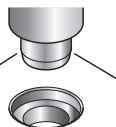
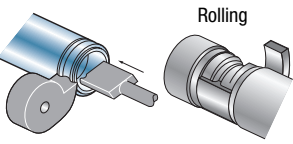
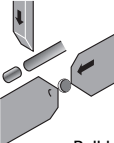
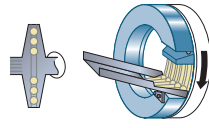
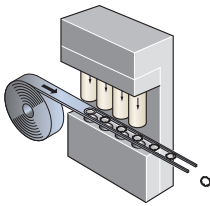
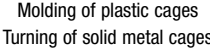
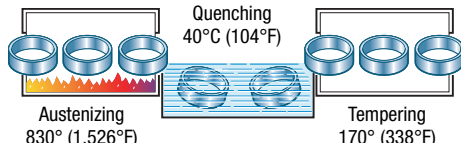
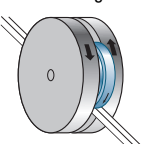
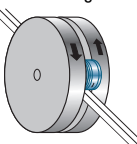
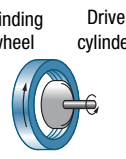
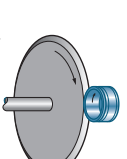
→ **Standard manufacturing process**

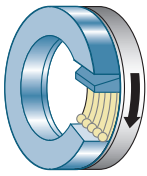
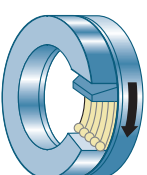
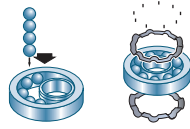
Operation	Rings	Rolling elements	Cage
Material	Tubes, bars 	Wire 	Coil strips 
Shaping	Turning  Forging  Rolling 	Cutting and cold heading  Ball blank 	Drawing steel cages  Molding of plastic cages Turning of solid metal cages 
Heat treatment	 <p>Austenizing 830° (1,526°F) Quenching 40°C (104°F) Tempering 170° (338°F)</p>		
Finition	Finishing Outer ring  Inner ring  Grinding wheel  Drive cylinder  Honing 	Grinding on grinding wheel  Lapping with abrasive paste between 2 plates 	
Assembly of the bearing	Washing, Marking, Final inspection, Packing 		

Bearing component variants

Inner ring

This chapter describes the specific manufacturing characteristics than can modify the standard bearing or bearings designed for a specific application. Some of these modifications are standard, others can be carried out on request.

→ Tapered bore

■ Tapered bore is generally used if one wants to mount a bearing on a wide-tolerance shaft with a tapered adapter sleeve which usually has a taper of 1:12, or when the usage of a withdrawal sleeve is necessary.

In certain special applications (paper mill machines, rolling machines, etc.), the inner ring is mounted on a tapered seat of the shaft. This enables the clearance to be fixed very accurately by the displacement of the inner ring on the seat.

The normal 1:12 taper is designated by the suffix K.

The special 1:30 taper is designated by the suffix K30.

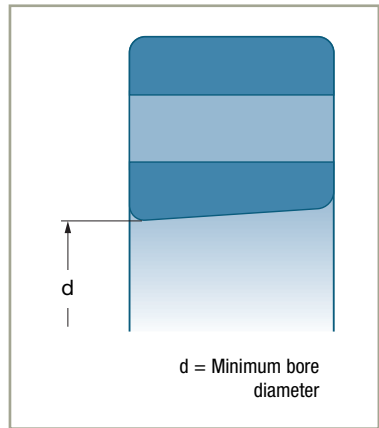

■ The 1:12 taper bore is produced in series on:

- Self-aligning ball bearings
- Spherical roller bearing.

However, in the 240xx and 241xx series, the 1:30 taper bore is used.

The dimensions of the tapered sleeves are indicated in the chapter *Tapered sleeves and Accessories*.

It should be noted that when a bearing is installed with a tapered sleeve, the shaft diameter is 5 mm less than the nominal bearing diameter, or a multiple of 5, depending on the size of the bearing.

→ Special corners

In certain cases, a special corner radius can simplify and bring economies to the fitting process.

■ Increased corner fillet radius

An increased corner radius makes it possible, by doing away with the bearing shoulder ring, to increase shaft stiffness, to reduce the length of the shaft and to avoid stress concentrations.

Example: installation of bearings on wheel pins.

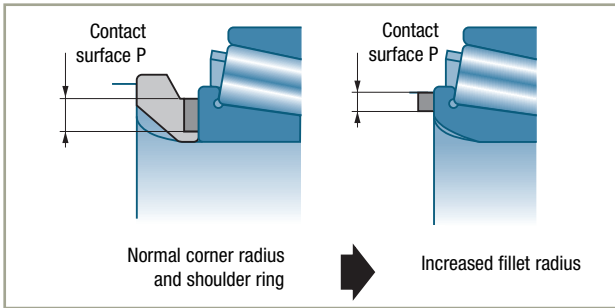

■ Reduced corner fillet radius

It allows smaller shoulder diameters to be accepted while maintaining an adequate contact surface. It is also beneficial if the shoulder is provided by a snap ring.

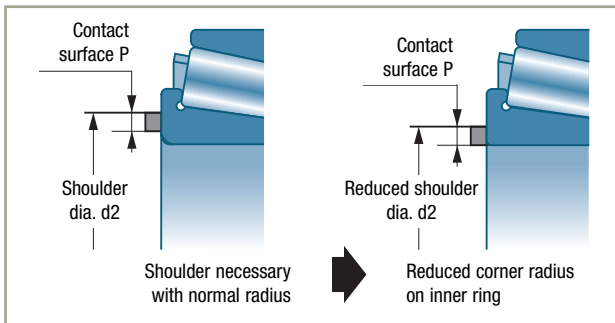

Bearing component variants *(continued)*

Definitions

■ Spherical outside diameter

For bearings designed to be mounted in self-aligning bearing units (or flanges) (single row radial-contact ball bearings).

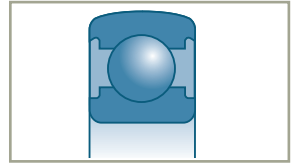

■ Increased thickness

This reinforcement enables the bearing to fulfill a roller function, with the outer ring rolling directly on a surface. The ring, with a straight or special profile, usually undergoes an appropriate heat treatment or surface treatment to reinforce its resistance to shocks and deformations.

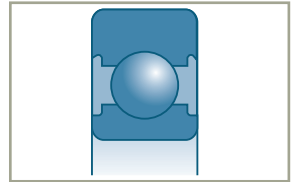

■ Special coatings

In certain applications (light loads, low speeds of rotation), over molding or the fitting of synthetic materials directly onto the outer ring allows the production of rollers of complex shape that function silently.

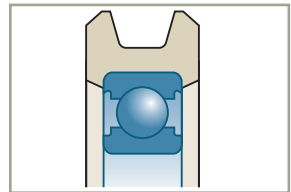

■ Lubrication groove and holes

This variant, designed to facilitate lubrication, is produced for the spherical roller bearings (suffix W33), with the exception of the 21300 series.

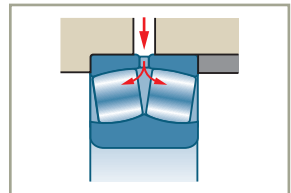

■ Snap ring groove

This groove is designed to accommodate a snap ring for axially positioning and locking the bearing.

The groove (suffix N) and the groove-snap ring system (suffix NR) are standard (ISO 464). The groove and installation dimensions are given in the "List of Standard Bearings". Snap rings are also available on double row shielded angular contact ball bearings.

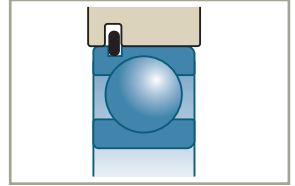
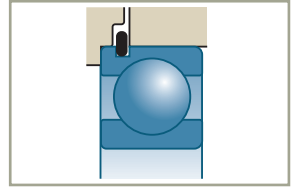

■ Flanged outer ring

This substitutes for the groove - snap ring system when the bearing ring is too narrow to have a groove.

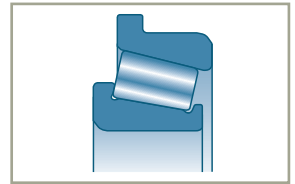

■ Reduced corner radius

The outer rings can be made with reduced corner radii in the same way as the inner rings and for the same reasons.

Bearing component variants (continued)

Other ring variants

The flexibility of the SNR ROULEMENTS machining resources enables the design of the bearing to be associated with surrounding parts in order to simplify fitting, reduce the number of parts, increase performance with:

- flanges and collars with smooth or threaded attaching holes,
- gear teeth cut in the rings,
- ...

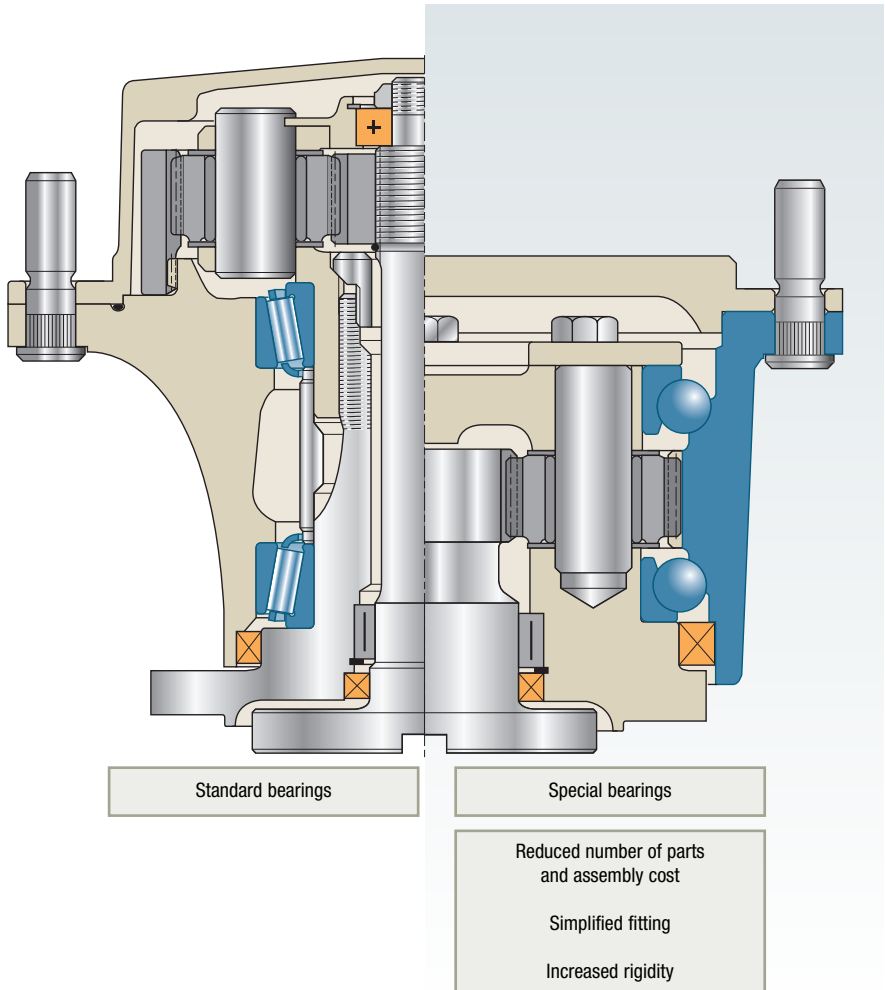

Cage

The function of the cage is to separate the rolling elements and keep them equally spaced to minimize friction and heating.

It also fulfils important complementary functions:

- keep the rolling elements assembled with one ring in detachable component bearings such as tapered and cylindrical roller bearings, self-aligning ball bearings, spherical roller bearings,
- help guide the rolling elements,
- ...

→ Materials

The cages are produced from several materials using various manufacturing processes. For each bearing there is a standard type of cage, which has always proved satisfactory in service, and is considered to be the best design for the majority of applications. The standard cage used for large bearings may differ from that for small bearings within the same series because of the different applications, manufacturing processes and costs. When a cage type becomes a standard cage, it is no longer identified by a specific suffix in the SNR bearing designation.

■ Molded synthetic material cages

The most commonly used material at present is polyamide 6.6 fiber glass reinforced.

These cages display interesting mechanical characteristics: low friction coefficient, elasticity, good impact and vibration resistance.

Furthermore, the molding process allows precise shapes that improve the guiding of the rolling elements. Due to the speed of changes in the world of synthetic materials, consult SNR for detailed information on the conditions of use of these cages.

The SNR standard sealed or shielded bearings can be equipped with this type of cage and compatible grease.

■ Cages made of stamped mild steel or brass sheets

In one or two pieces, riveted, fold clamped or welded together. These cages can be given a surface treatment to improve the friction coefficient.

■ Machined cages: phenolic resin, copper base alloys, aluminium alloys

For large-sized cages produced in small quantities, the machined brass cage is often standard, and in this case the bearing reference is always followed by the cage suffix (M, MA, or MB).

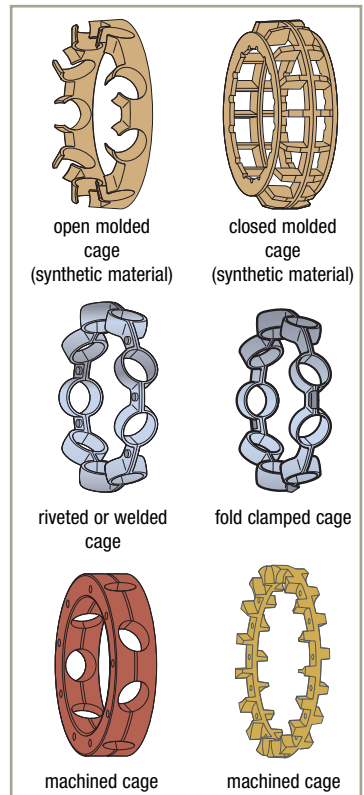

Bearing component variants *(continued)*

→ Cage centering

The cages can be centered:

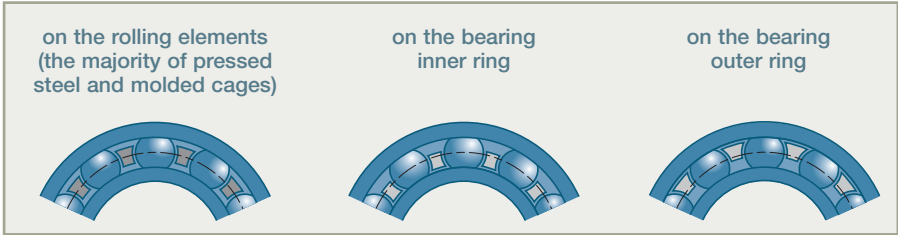

The centering choice depends on the bearing operating criteria: vibration, impacts, high speeds, speed variations,...

→ Choice of a special cage



The choice of a special cage will depend on the particular bearing operating criteria: Temperature, lubrication, vibration, sudden acceleration and deceleration, shaft-housing misalignment.

See the table on the opposite page.

In certain applications where a substantial increase in the dynamic loading capacity is needed (speed reducers, gearboxes, etc.) or static loading capacity (rollers, pulleys, etc.) special cageless bearings can be used.

It should be noted that the maximum speed for this type of bearing is lower than that of the corresponding standard bearing. Its lubrication demands a certain amount of attention due to the relative friction of the rolling elements.

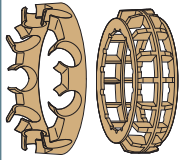

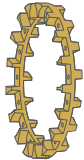
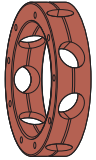
	Molded cage	Pressed steel or brass sheet cage	Machined brass cage	Machined phenolic resin cage
				
Maximum speed	<ul style="list-style-type: none"> ▶ That of the bearing 	<ul style="list-style-type: none"> ▶ That of the bearing 	<ul style="list-style-type: none"> ▶ Enables the maximum speed of the bearing to be increased 	<ul style="list-style-type: none"> ▶ Usually centered on a ring, which enables the maximum speed of the bearing to be increased
Temperature	<ul style="list-style-type: none"> ▶ Polyamide 6/6: +120°C/+248°F continuous service, +150°C/+302°F intermittently ▶ Other materials, consult SNR 	<ul style="list-style-type: none"> ▶ Does not limit the bearing operating temperature 	<ul style="list-style-type: none"> ▶ Does not limit the bearing operating temperature 	<ul style="list-style-type: none"> ▶ +110°C/+230°F max. in continuous service
Lubrication	<ul style="list-style-type: none"> ▶ Good friction coefficient ▶ Good behaviour when lubrication is deficient 	<ul style="list-style-type: none"> ▶ Metal-to-metal contact, therefore lubrication is important 	<ul style="list-style-type: none"> ▶ Low brass-to-metal friction coefficient 	<ul style="list-style-type: none"> ▶ Excellent coefficient of friction ▶ Cage impregnated with oil, optimum bearing lubrication
Resistance to vibration	<ul style="list-style-type: none"> ▶ Excellent behaviour - Lightness - Elasticity 	<ul style="list-style-type: none"> ▶ Restricted by: - mechanical strength - method of assembly - potential unbalance 	<ul style="list-style-type: none"> ▶ Excellent resistance ▶ Maintains despite the dynamic unbalance loads 	<ul style="list-style-type: none"> ▶ Good behaviour with cage centered on a ring ▶ Low inertia ▶ Good balance
Sudden acceleration and deceleration	<ul style="list-style-type: none"> ▶ Excellent behaviour - Lightness - Elasticity 	<ul style="list-style-type: none"> ▶ Risk of cage failure 	<ul style="list-style-type: none"> ▶ High mechanical strength but: - Lack of flexibility - High inertia 	<ul style="list-style-type: none"> ▶ Excellent behaviour due to: - Low inertia - Good mechanical strength
Misalignment between shaft and housing	<ul style="list-style-type: none"> ▶ Excellent behaviour - Elasticity 	<ul style="list-style-type: none"> ▶ Risk of cage failure 	<ul style="list-style-type: none"> ▶ Use not recommended 	<ul style="list-style-type: none"> ▶ Use not recommended
Remarks	<ul style="list-style-type: none"> ▶ Cage replacing the steel cage for many types of bearings 		<ul style="list-style-type: none"> ▶ High cost ▶ Usually reserved for highspeed and/or highprecision bearings 	<ul style="list-style-type: none"> ▶ High cost ▶ Usually reserved for high speed and / or high precision bearings

Shielding and sealing

The active parts of the bearing: rolling elements, raceways, cage, must always remain absolutely clean and well lubricated. Shielding and sealing serve to ensure the permanence of these two factors that are vital for the bearing life, by preventing contaminating agents from entering the bearing and by retaining the grease.

Two types of sealing devices are normally used with the bearings

■ Friction-free shields

These devices are based on the effect produced by a narrow space between rotating parts and fixed elements. These shielding devices produce virtually no friction and no wear. They are particularly suited to high speeds of rotation and high temperatures. Their efficiency can be reinforced by injecting grease into the bearing through the narrow gap between shield and inner ring.

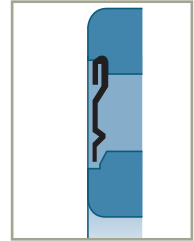

■ Friction seals (contact)

The seal exerts pressure on the conjugate surface, usually by means of a lip. This prevents the ingress of impurities and moisture and/or loss of lubricant.

The pressure can be created:

- either by the load exerted by a spring incorporated at the end of the seal,
- or by the elasticity of the seal material and appropriate fitting of the lip on its contact surface.

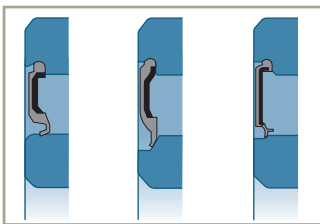
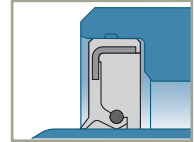
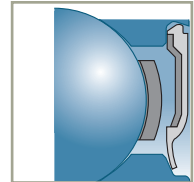

Standard seals

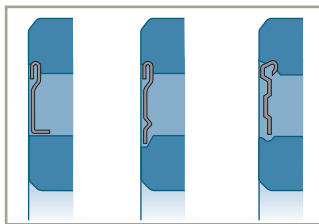

Shields

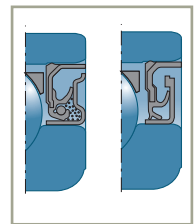

Special seals



SNR proposes a wide and diverse range of shields and seals, either fully integrated in the bearing or reinforced by a front lip. Depending on the applications, these devices can be replaced or reinforced by a protection mechanism that is independent of the bearing.

Shielding and sealing devices external to the bearing

The shielding or sealing devices integrated in the bearings can be replaced or reinforced by a protection independent of the bearing, depending on the applications. Protection devices that are independent of the bearing may be with or without friction. They may be combined for increased protection.

	Devices with friction				Devices without friction		
	Radial effect		Axial effect				
Type							
	Felt	Metal-plastic seal	Mechanical seal	Front-lip seal	Grooves	Labyrinth seal	Shield
Maximum linear speed (m/sec)	4	<ul style="list-style-type: none"> ▶ Acrylic nitrile NBR: 15 ▶ Polyacrylate ACM: 18 ▶ Fluoroelastomer FKM: 20 	16	7			
Maximum service temperature °C (°F)	-40 +110 (-40) (+230)	<ul style="list-style-type: none"> ▶ Acrylic nitrile NBR -30 (-22) +110 (230°) ▶ Polyacrylate ACM -10 (14) +170 (+338) ▶ Fluoroelastomer FKM -40 (-40) +200 (+392) 	-40 +150 (-40) (+302)	-40 +110 (-40) (+230)			
Maximum misalignment	0.01 rad 0.5°	0.01 rad 0.5°	0.01 rad 0.5°	0.02 rad 1°	0.001 rad 0.06°	0.001 rad 0.06°	0.001 rad 0.06°
Seal seat	Hardness	Min 30HRc or 300 HV	Min 40HRc or 450 HV	Seal integrated in seal			
	Surface condition (seating) (Ra max)	3.2 µm	0.8 µm		3.2 µm	0.8 µm (shaft)	0.8 µm (shaft)
Particular points	<ul style="list-style-type: none"> ▶ Soak the felt in oil at 80°C (176°F) before fitting ▶ Standard grooves 	<ul style="list-style-type: none"> ▶ Provide a chamfer on the shaft to ease entry of the lips ▶ Grease seal and seals before fitting 	<ul style="list-style-type: none"> ▶ This seal can withstand relatively high pressures 	<ul style="list-style-type: none"> ▶ The use of fluoroelastomer seals increases the operating temperature capability and speed range 	<ul style="list-style-type: none"> ▶ 3 grooves minimum ▶ Clearance between shaft and housing of 0.3 to 0.5 mm for Ø < 50 ▶ 0.8 to 1.2 mm for Ø > 50 ▶ Axial clearance of 1 to 2 mm for Ø < 50 ▶ 2 to 4 mm for Ø > 50 		
Applications	<ul style="list-style-type: none"> ▶ Split pillow blocks 	<ul style="list-style-type: none"> ▶ General 	<ul style="list-style-type: none"> ▶ Fluid-tight 	<ul style="list-style-type: none"> ▶ Reinforced sealing against contaminants 	<ul style="list-style-type: none"> ▶ Precision component ▶ High speed ▶ Poorly contaminated environments 	<ul style="list-style-type: none"> ▶ Precision component ▶ High speed ▶ Poorly contaminated environments 	<ul style="list-style-type: none"> ▶ Used to reinforce another type of sealing against contamination ▶ Acts by centrifuging
Recommended lubrication	<ul style="list-style-type: none"> ▶ Grease 	<ul style="list-style-type: none"> ▶ Grease ▶ Oil 	<ul style="list-style-type: none"> ▶ Grease ▶ Oil 	<ul style="list-style-type: none"> ▶ Grease 	<ul style="list-style-type: none"> ▶ Grease ▶ Oil 	<ul style="list-style-type: none"> ▶ Grease ▶ Oil 	

Shielding and sealing (continued)

Other types of seals

Other types of sealing can be integrated in the bearing.

For many applications, integrating the seal saves space and weight, thereby reducing the cost of the sealing function.

Some examples:

■ Radial sealing ring with spring

Sealing rings with radial lips equipped with a spring suit numerous industrial applications. They are particularly suited to those requiring oil sealing, but can also be used with greased bearings.

This type of seal can also be equipped with a lip protecting against dust and external dirt.

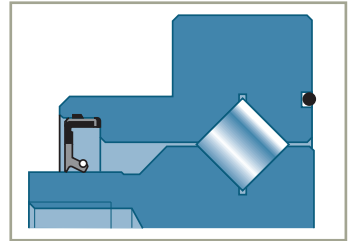

■ O-ring

O-rings can be integrated in the bearing to ensure static sealing against oil or grease.

■ Linear seal

Seal formed by one or more lips in non-reinforced elastomer. The seal is produced by the meter and can be adapted to bearings of different diameters.

This type of seal is well suited to greased bearings.

Used extensively in robotics applications.

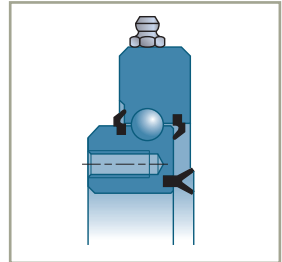

■ Mirror seal

In all applications exposed to high wear stresses from mud, sand or dust, it is possible to integrate a mirror seal.

These seals are made by two rubbing metal rings mounted elastically with two O-rings.

This type of sealing is particularly suitable for civil engineering applications (caterpillar vehicles, sand preparation plants, etc.) and mine working machines.

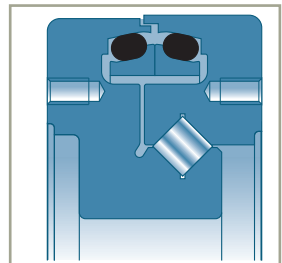

Bearing Life

Nominal life	56
■ Types of failure	56
■ Basic formula	58
■ Basic dynamic load of the bearing	59
■ Equivalent radial dynamic load P	60
■ Definition	61
<i>Axial load factor Y</i>	61
■ Definition of the static capacity	61
■ Equivalent static load	63
■ Variable loads or speeds	64
■ Design calculation of a shaft mounted on 2 angular contact bearings	65
<i>Radial balance of the shaft</i>	65
<i>Axial balance of the shaft</i>	66
■ Required service life	67
Corrected nominal life	68
■ Bearing reliability	74
<i>Definition of the a_1 factor</i>	74
<i>Reliability for a chosen operating time</i>	75
<i>Specifying a_1 and reliability for a chosen life duration</i>	75
<i>Duration and reliability of a set of bearings</i>	76
■ Influence of lubrication	77
<i>Separating power of the lubricant</i>	77
<i>Elasto-hydrodynamic theory (EHD)</i>	77
<i>Determination of the minimum required viscosity</i>	78
Parameters influencing bearing life	80
■ Influence of the temperature	80
<i>Normal operating temperatures</i>	80
■ Influence of the operating clearance	81
<i>Radial-contact bearing under radial load</i>	81
<i>Angular-contact bearing under radial and axial load</i>	81
■ Influence of an excessive load	82
■ Influence of form and position defects	82
<i>Shape defects</i>	82
<i>Misalignment</i>	82
Friction and bearing speed	84
■ Friction	84
■ Bearing speed	85
<i>Theory of the Standard ISO 15312</i>	85
<i>SNR theory</i>	87

Nominal life

Types of failure

The principal measure of the performance of a bearing is its service life, that is to say the number of revolutions it can make before the first sign of spalling appears.

Apart from "seizure" type failure which can be the consequence of inadequate lubrication, the main types of failure can be classified in 3 categories:

- deep spalling initiated at depth (DSID)
- surface spalling initiated at the surface (SSIS)
- deep spalling initiated at the surface (DSIS)

■ Deep spalling initiated at depth (DSID)

This is the "conventional" failure of a bearing operating under normal conditions, when the lubrication is effective.

The principle of bearing construction leads to contact between the rolling elements and rings that are the location of very high specific loads.

The Hertz stresses (figure opposite) at this level have the following consequences:

- compression stresses, maximal at the surface with values that can reach 3,500 N/mm²
- shear stresses, maximal in sub-surface with values that can reach 1,000 N/mm²

If the level of the load is sufficient and applied under clean lubricated environmental conditions (see page 77), type EHD, the alternating stresses to which the raceways are subjected sooner or later lead to a crack within the material. This crack starts from inclusions in the sublayer in the area where the Hertz stresses are maximal.

The crack appears in the matrix in the vicinity of an inclusion.

The crack propagates towards the surface and causes the detachment of a fragment of steel, the first sign of failure by spalling.

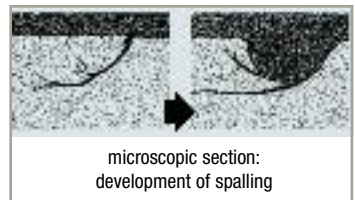
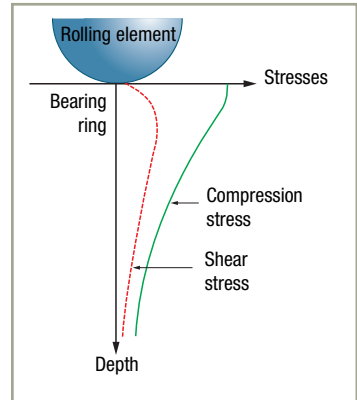

■ Superficial spalling initiated at the surface (SSIS)

In the presence of small (from a few μm to $50\ \mu\text{m}$) hard (harder than the bearing elements, i.e. 700 HV10) particles, one finds wear of the bearing elements due to metal-to-metal contact, resulting from uneven lubrication at that sensitive point.

This leads to the damage of the active surfaces through a very superficial form of spalling also called "peeling", from 10 to 20 microns in depth and affecting a large area of the raceways. This is a slow failure process. It is of the same type as that caused by an insufficient oil film resulting from excessively low viscosity..

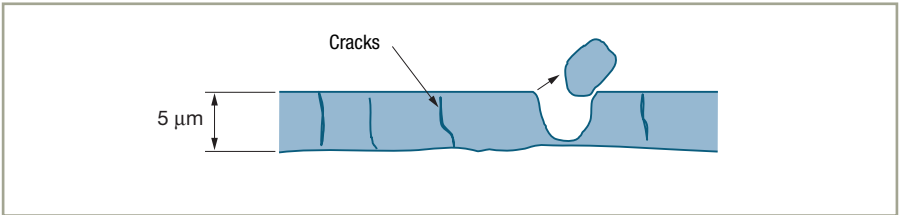

■ Deep spalling initiated at the surface (DSIS)

When the contamination consists of coarser particles (from $20\ \mu\text{m}$ to $300\ \mu\text{m}$, and larger), the flow of particles between the rolling element and the ring leads to local plastic deformation of the raceway. The effect of this contamination differs according to its hardness.

If the particle is sufficiently ductile, it can undergo plastic deformation without breaking and form a pancake. On the other hand, if it is brittle, it shatters under contact while causing plastic deformation of the bearing elements.

These new fragments then behave in accordance with the 2nd SSIS mechanism described above. There is then competition between the damage caused by the local plastic deformation due to the indentation and that resulting from the abrasive wear caused by the particle fragments.

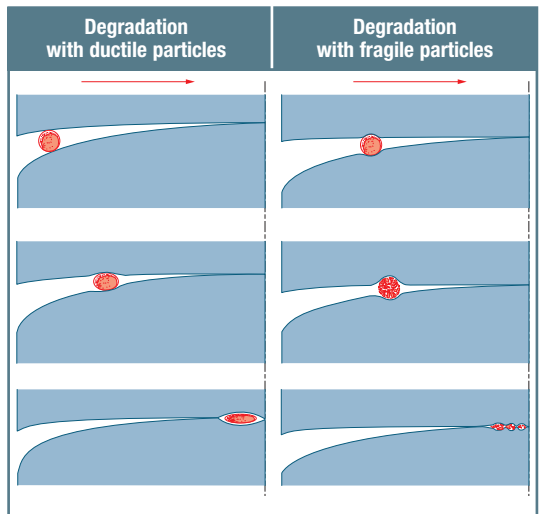

Nominal life *(continued)*

In the case of an indentation, the spalling does not initiate directly on the edge of the indentation. One finds a protected zone in the plastically deformed volume and the crack starts beyond this zone and leads to deep spalling initiated at the surface (DSIS).

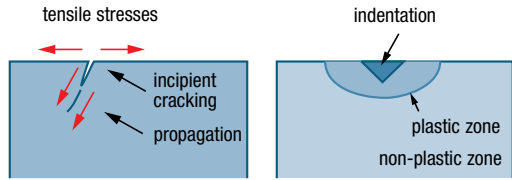

Considering the diversity of the contaminating particles found in the oil of a mechanical component and its evolution when new and after running in, and also considering the nature of the rolling elements (rollers or balls), which are affected to a greater or lesser extent by the phenomenon of slipping, the failure is often a combination of the SSIS and DSIS types.

Basic formula

The service life of a bearing can be calculated more or less precisely, depending on the defined operating conditions.

The simplest method recommended by standard ISO 281, enables one to calculate the service life reached by 90% of bearings operating under a dynamic load.

➔ The simplified method of calculation below is based on fatigue being the cause of failure (spalling type DSIS)

■ To determine the simplified service life per standard ISO 281, one calculates:

▶ The equivalent dynamic radial load P

$$P = X \cdot F_r + Y \cdot F_a$$

▶ The nominal life L_{10}

$$L_{10} = (C / P)^n 10^6 \text{ in revolutions}$$

or

$$L_{10} = (C / P)^n / 60N \text{ in hours}$$

n : 3 for ball bearings or ball thrust bearings

n : 10/3 for roller bearings or roller thrust bearings

One sees that: if $P = C$, $L_{10} = 1$ million revolutions

This is therefore the load under which the bearings have a nominal service life of one million revolutions.

It is also called the dynamic load capacity.

Basic dynamic load of the bearing

■ The basic dynamic load of the bearing defined in the chapter corresponding to each family, is calculated in accordance with standard ISO 281 using the formulae given below:

Ball bearings (for ball diameter < 25.4 mm)

$$C = f_c(i \cdot \cos\alpha)^{0.7} Z^{2/3} \cdot D_w^{1.8}$$

Roller bearings

$$C = f_c(i \cdot l \cdot \cos\alpha)^{7/9} Z^{3/4} \cdot D_w^{29/27}$$

Ball thrust bearings (for ball diameter < 25.4 and $\alpha = 90^\circ$)

$$C = f_c \cdot Z^{2/3} \cdot D_w^{1.8}$$

■ Remark

► It can be seen that the exponent that affects the diameter D_w of the rolling element is greater than that concerning their number Z . Consequently one cannot compare the capacity of two bearings with the same part number but a different internal definition simply taking into account the number of rolling elements. The other parameters in the calculation formula must also be taken into account.

► Load capacity of double bearings

As regards the bearings with two rows of rolling elements ($i = 2$) or assemblies comprising two identical bearings, the capacity (C_e) of the assembly is that of one row (C) multiplied by:

for ball assemblies

$$2^{0.7} = 1.625$$

for roller assemblies

$$2^{7/9} = 1.715$$









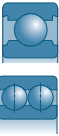

It can thus be seen that by doubling the number of bearings increases the load capacity by 62.5 or 71.5% depending on the type used. The load capacity and therefore the service life are not doubled.

Nominal life *(continued)*

Equivalent dynamic radial load P

$$P = X \cdot F_r + Y \cdot F_a$$

X and Y = load factors defined in the table below
 F_a and F_r = axial and radial forces applied to the bearing

Type	Cross-section	Series	Contact angle	F_a/C_0		$F_a / F_r \leq e$		$F_a / F_r > e$	
						X	Y	X	Y
Single- or double-row radial contact ball bearings		60-62-63-64 160-618-619 622-623 42-43		0.014	0.19	1	0	0.56	2.30
				0.028	0.22				1.99
				0.056	0.26				1.71
				0.084	0.28				1.55
				0.110	0.30				1.45
				0.170	0.34				1.31
				0.280	0.38				1.15
				0.420	0.42				1.04
0.560	0.44	1.00							
Single-row radial contact ball bearings, with higher than normal residual clearance		60-62-63-64 160-618-619 622-623		0.014	0.29	1	0	0.46	1.88
				0.029	0.32				1.71
				0.057	0.36				1.52
				0.086	0.38				1.41
				0.110	0.40				1.34
				0.170	0.44				1.23
				0.280	0.49				1.10
				0.430	0.52				1.01
0.570	0.54	1.00							
Single-row angular contact ball bearings		72-73	40°		1.14	1	0	0.35	0.57
		QJ2-QJ3	30°		0.80	1	0	0.39	0.76
			35°		0.95	1	0	0.37	0.66
Double-row angular contact ball bearings		32-33	35°		0.95	1	0.66	0.60	1.07
		32..A-33..A	25°		0.68	1	0.92	0.67	1.41
		52-53	32°		0.86	1	0.73	0.62	1.17
		32..B-33..B							
Double-row self-aligning ball bearings		12-13			see list of Standard bearings	1	see list of Standard bearings	0.65	see list of Standard bearings
		22-23							
		112-113							
Tapered roller bearings		302-303-313			see list of Standard bearings	1	0	0.40	see list of Standard bearings
		320-322-322..B							
		323-323..B 330-331-332							
Double-row spherical roller bearings		213-222-223			see list of Standard bearings	1	see list of Standard bearings	0.67	see list of Standard bearings
		230-231-232							
		240-241							
Cylindrical roller bearings		N..2-N..3-N..4			-	1	-	1.00	-
		N..10							
		N..22-N..23							
Single- or double-direction ball thrust bearing		511-512-513			-	-	-	-	1.00
		514							
Spherical roller thrust bearing		293-294			1.82	-	-	1.20	1.00

Definition

→ Axial load factor Y

The way in which the axial load factor Y , which depends on the bearing contact angle, is calculated differs according to the type of bearing:

■ Radial ball bearings

The contact angle is zero under a purely radial load. Under an axial load, the local deformations from ball-to-raceway contact cause relative axial displacement of the two rings. The contact angle (α) therefore increases as a function of the applied axial load. The ratio F_a/C_0 is used to determine the value of Y and therefore take into account the modification of contact angle due to the axial force.

■ Angular contact bearings

The contact angle is determined by construction and varies little as a function of the combined loads. The axial load factor Y for a given contact angle is therefore considered in an initial approximation as being constant. The angular contact ball bearings, with an identical contact angle for all the bearings, are calculated with the same load factor Y . With tapered roller bearings, Y varies according to the series and dimension.

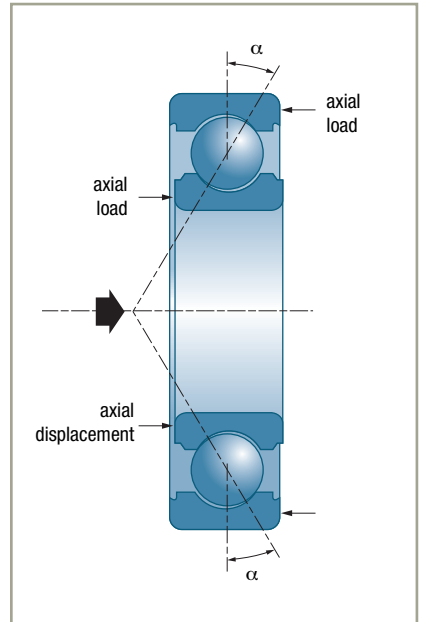

Definition of the static capacity

■ The size of the bearing must be chosen from the static load when:

- the bearing is stationary or making slight oscillating movements and withstanding continuous or intermittent loads,
- the bearing is subjected to shocks during normal rotation.

Nominal life *(continued)*

A static load applied on a bearing can, because of the stresses in the contact between the rolling elements and the raceways, lead to permanent local deformation that is detrimental to the proper operation of the bearing when rotating.

A maximum permissible radial load is therefore defined such as the one inducing stress in the stationary bearing that can be tolerated in the majority of applications without reducing service life and rotation.

The value C_0 of this maximum permissible load is called the basic static capacity of the bearing (or static capacity).

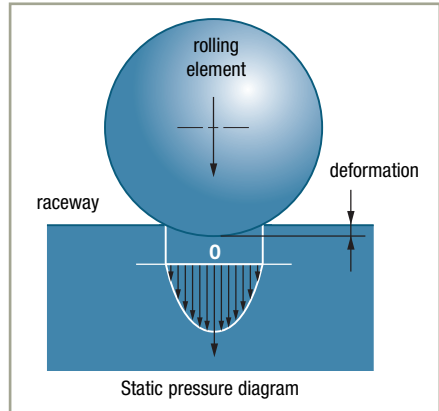

■ Basic static capacity of a bearing C_0

This has been defined in ISO 76 standard as the radial load (axial in the case of thrust bearings) that creates at the most heavily loaded point of contact (between rolling element and raceway) a Hertz pressure of:

- 4200 MPa for ball bearings and ball thrust bearings (all types except self-aligning ball bearings)
- 4600 MPa for self-aligning ball bearings
- 4000 MPa for roller bearings and roller thrust bearings (all types)

$$1\text{MPa} = 1\text{Mégapascal} = 1 \text{ N/mm}^2$$

■ Equivalent static load P_0

In the case where the bearing is subjected to combined static loads such as F_r a radial component, and F_a the axial component, one calculates an equivalent static load to compare it to the static capacity of the bearing.

The static load capacity of the bearing is to be considered more as a size magnitude than a precise limit not to be exceeded.

The safety factor

$$f_s = C_0 / P_0$$

C_0 is the basic static capacity defined in the tables of bearing characteristics.

Usual minimum values for the safety factor f_s :

- 1.5 to 3 for severe requirements
 - 1.0 to 1.5 for normal conditions
 - 0.5 to 1 for operation without noise or precision requirements
- If a rotating bearing with quiet operation requirements is needed, the safety factor f_s must be high.

Equivalent static load







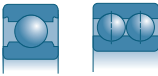

The equivalent static load is the higher of the two values if

$$P_0 = F_r$$

$$P_0 = X_0 \cdot F_r + Y_0 \cdot F_a$$

if F_r and F_a are the applied static forces.

■ The factors X_0 and Y_0 are defined in the table below:

Type	Cross-section	Series	Contact angle	X_0	Y_0
Single- or double-row radial contact ball bearings		60-62-63-64 160-618-619-622 623 42-43		0.6	0.5
Single-row angular contact ball bearings		72 - 73	40°	0.5	0.26
		QJ2 - QJ3	35°	0.5	0.29
Double-row angular contact ball bearing		32 - 33	35°	1.0	0.58
		32..A - 33..A	25°	1.0	0.76
		52 - 53 32B - 33B	32°	1.0	0.63
Double-row self-aligning ball bearings		12 - 13 22 - 23 112 - 113		0.5	See list of Standard Bearings
Tapered roller bearings		302 - 303 - 313 320 - 322 - 322..B 323 - 323..B - 330 331 - 332		1.0	
Double-row spherical roller bearings		213 - 222 - 223 230 - 231 - 232 240 - 241		1.0	
Cylindrical roller bearings		N..2 - N..3 - N..4 N..10 N..22 - N..23		1.0	
Single-direction ball thrust bearings		511 - 512 - 513 514		0	1
Spherical roller thrust bearings		293 - 294		2.7 si $F_r / F_a < 0.55$	1

Nominal life *(continued)*

Variable loads or speeds

■ When a bearing functions under variable loads or speeds, an equivalent load and speed are determined in order to calculate the service life.

▸ Constant load and variable speed of rotation

Equivalent speed $N_e = t_1 \cdot N_1 + t_2 \cdot N_2 + \dots + t_z \cdot N_z$ With $\sum_{i=1}^z t_i = 1$

▸ Variable load and constant speed of rotation

Equivalent load $P_e = (t_1 \cdot P_1^n + t_2 \cdot P_2^n + \dots + t_z \cdot P_z^n)^{1/n}$ With $\sum_{i=1}^z t_i = 1$

▸ Cyclic load and constant speed of rotation

Equivalent load

• Sinusoidal load

$$P_e = 0.32 P_{\min} + 0.68 P_{\max}$$

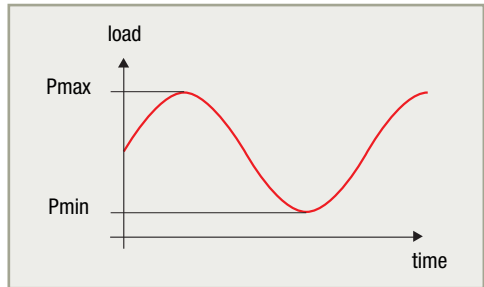

• Linear load

$$P_e = 1 / 3 (P_{\min} + 2 P_{\max})$$

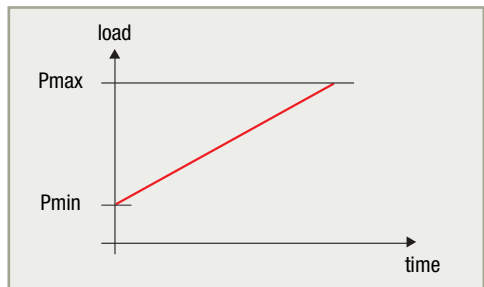

■ If the speed of rotation and the load are variable, the service life is calculated for each level of use, then the duration is weighted for the cycle as a whole.

► Variable load and speed of rotation

Weighted duration $L = (t_1 / L_1 + t_2 / L_2 + \dots + t_z / L_z)^{-1}$ with $\sum_{i=1}^z t_i = 1$

with:

- t_i Duration of use
- N_i Speed of rotation for duration of use t_i
- P_i Load for duration of use t_i
- L_i Service life for duration of use t_i
- n 3 for ball bearings and ball thrust bearings
- n 10/3 for roller bearings and roller thrust bearings

Design calculation of a shaft mounted on 2 angular contact bearings

Shaft mounted on 2 simple non-preloaded bearings subjected to axial and radial loads.

→ Radial balance of the shaft

■ Calculation of the radial loads F_{r1} and F_{r2} applied on the bearing load application points by static radial balance of the shaft.

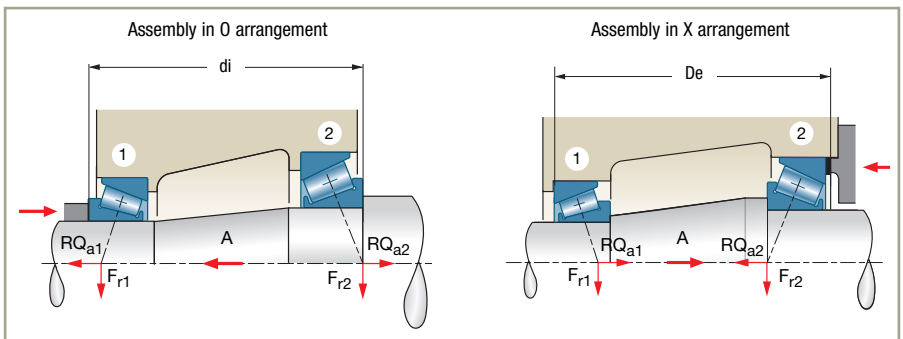

Nominal life *(continued)*

→ Axial balance of the shaft

■ As the raceways of angular contact bearings are displaced, the radial loads F_{r1} and F_{r2} produce an axial reaction force called an induced axial force.

If bearing 1 is the bearing whose induced axial force is in the direction of the external axial force A , the shaft equilibrium is:

$$A + RQ_{a1} = RQ_{a2}$$

With RQ_{a1} and RQ_{a2} : axial loads applied to the bearings calculated in the table below:

► Load case:

$$A + (F_{r1} / 2 Y_1) > (F_{r2} / 2 Y_2)$$

bearing 1 works with clearance

	Bearing 1	Bearing 2
Applied axial load	$RQ_{a1} = F_{r1} / 2 Y_1$	$RQ_{a2} = A + (F_{r1} / 2 Y_1)$
Axial load used in the calculation of the equivalent dynamic load	$F_{a1} = 0$	$F_{a2} = RQ_{a2}$

► Load case:

$$A + (F_{r1} / 2 Y_1) < (F_{r2} / 2 Y_2)$$

bearing 2 works with clearance

	Bearing 1	Bearing 2
Applied axial load	$RQ_{a1} = (F_{r2} / 2 Y_2) - A$	$RQ_{a2} = F_{r2} / 2 Y_2$
Axial load used in the calculation of the equivalent dynamic load	$F_{a1} = RQ_{a1}$	$F_{a2} = 0$

Required bearing life

■ The required bearing life is set by the manufacturer of the equipment in which the bearing is fitted.

For example, you will find below the orders of magnitude of these service life limits usually adopted for machines working in miscellaneous mechanical sectors:

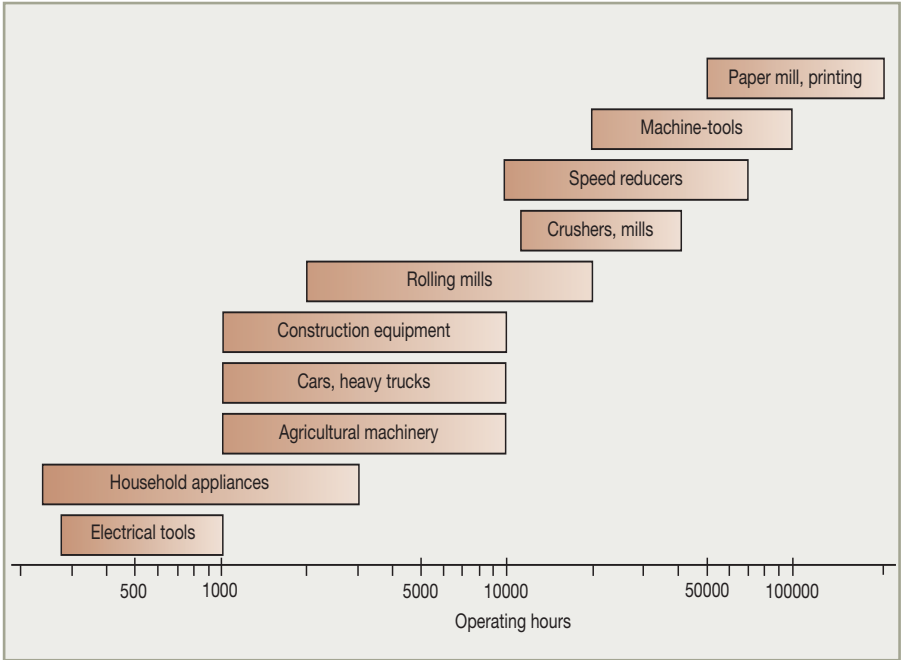

Corrected nominal life

■ **Base nominal life, L_{10}** , is often a satisfactory estimate of a bearing's performance capabilities. It refers to 90% reliability and conventional operating conditions. In certain applications, it may be necessary to compute service life for a different reliability level or for specific lubrication and contamination conditions.

With modern, high quality bearing steels, it is possible to obtain, under low loads and in favorable operating conditions, very long service life limits compared with L_{10} . A service life shorter than L_{10} may occur due to unfavorable operating conditions.

Below a given load C_U , a modern, high-quality bearing can reach infinite service life if lubrication, cleanliness and other operating conditions are favorable.

This load, C_U can be accurately determined according to the type of bearing and its internal geometry, the profile of the rolling elements and the races, and the fatigue limit of the race material. A sufficient approximation can be computed based on the bearing's static capacity.

■ **The international Standard ISO 281** introduces a service life correction factor, a_{ISO} which allows you to compute a corrected nominal service life as follows:

$$L_{nm} = a_1 a_{ISO} L_{10}$$

This factor provides an estimate of the influence of lubrication and contamination on bearing service life, also taking into account steel fatigue limit.

The evaluation method for a_{ISO} defined by ISO281, is rather difficult to apply for a non-specialist. Therefore, SNR has determined the best way to provide its clients with a simple a_{ISO} determination means, based on the assumption that the fatigue load, C_U , is directly linked with the bearing's static capacity and that the contamination factor is constant whatever the lubrication conditions and the mean diameter of the bearing.

The method proposed by SNR provides a quick, graphic evaluation of the a_{ISO} factor.

Our engineers are at your disposal to more accurately determine this factor, as required.

The 4 diagrams in the following pages allow a_{ISO} determination for ball bearings, roller bearings, ball thrust bearings and roller thrust bearings according to the method below:

■ a_{ISO} determination method (standard ISO 281)

1. Define the lubricant viscosity at operating temperature from the diagram on page 78.
Take the basic oil viscosity for the lubricated bearings.
2. Define the pollution level:
 - ▶ **High cleanliness**
Oil filtered through an extremely fine mesh filter; usual conditions for life lubricated and sealed bearings.
 - ▶ **Normal cleanliness**
Oil filtered through a fine mesh filter; usual conditions for life lubricated bearings, with shields.
 - ▶ **Slight contamination**
Slight contamination in the lubricant.
 - ▶ **Typical contamination**
Oil with coarse filtering; wear particles or particles from the ambient environment.
Usual conditions for greased bearings without integral seals.
 - ▶ For **heavy contamination**, consider that a_{ISO} will be less than 0.1.
3. From the loads applied on the bearing, compute the equivalent load, P, and the static capacity / equivalent load ratio: C_0 / P .
4. On the graphic corresponding to the type of bearing or thrust bearing to be evaluated, define point A versus pollution level and C_0/P .
5. Define point B from the mean diameter of the bearing:
 $dm = (\text{bore} + \text{outer diameter}) / 2$
6. Define point C versus bearing rotating speed.
7. Define point D versus lubricant viscosity at operating temperature.
8. Point E, at intersection between the straight line from points B and D defines the a_{ISO} value zone.

Corrected nominal life (continued)

Ball bearings: a_{ISO} factor estimation

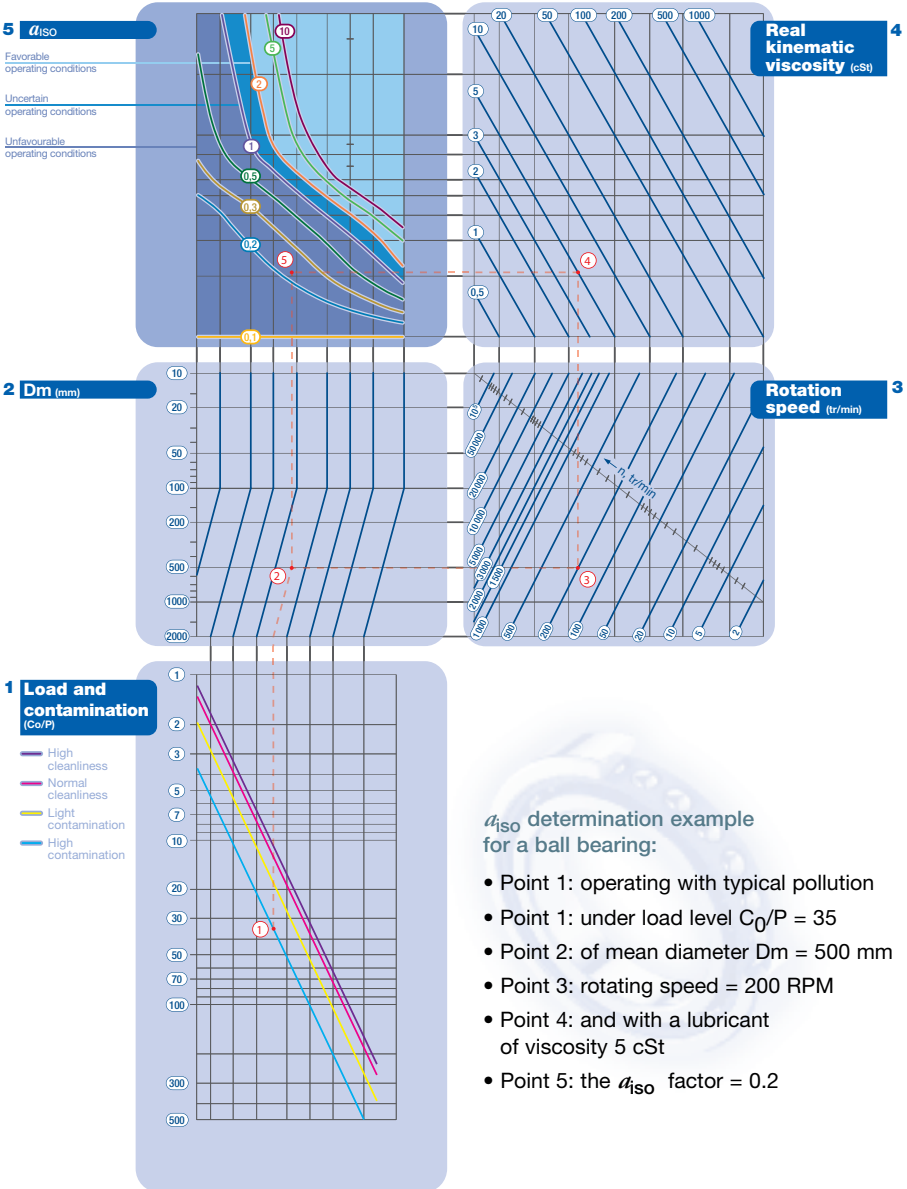

Roller bearings: a_{ISO} factor estimation

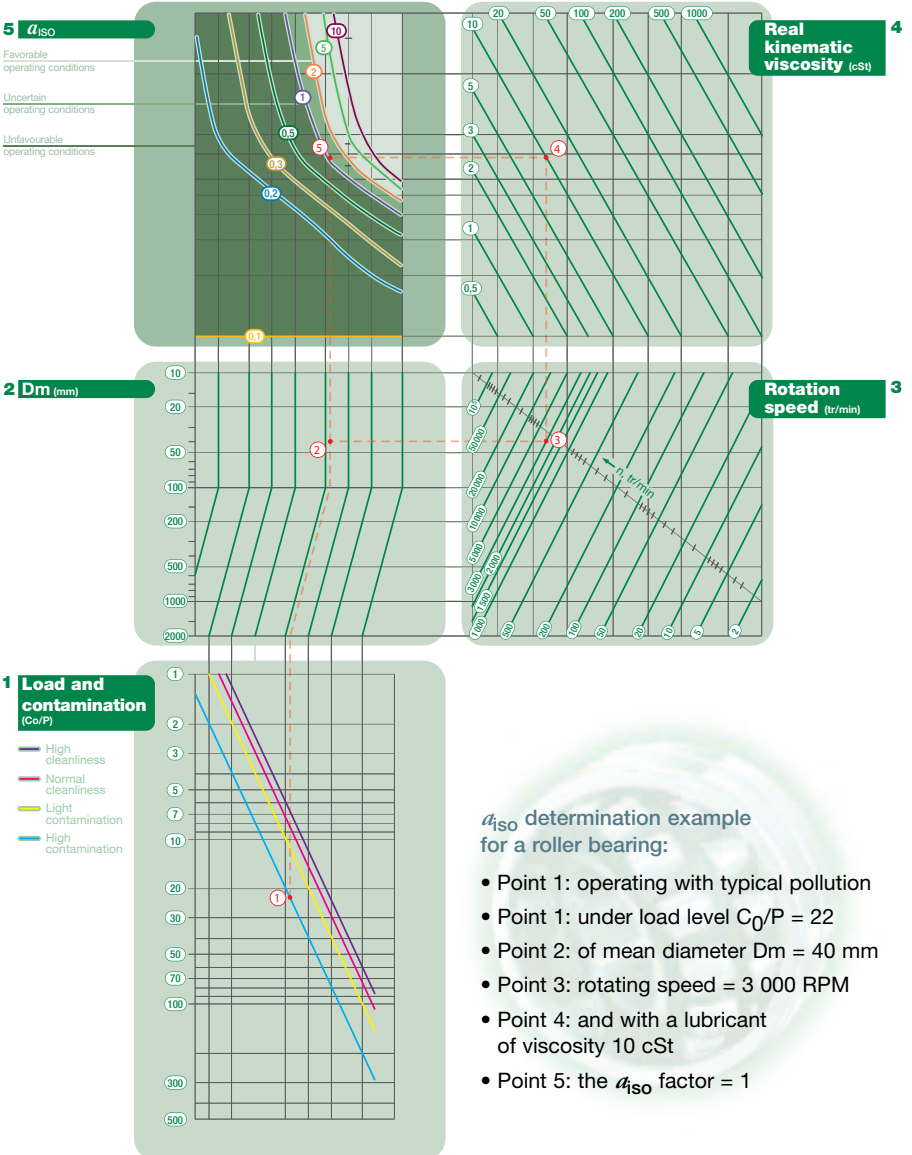

Corrected nominal life (continued)

Ball thrust bearings: a_{ISO} factor estimation

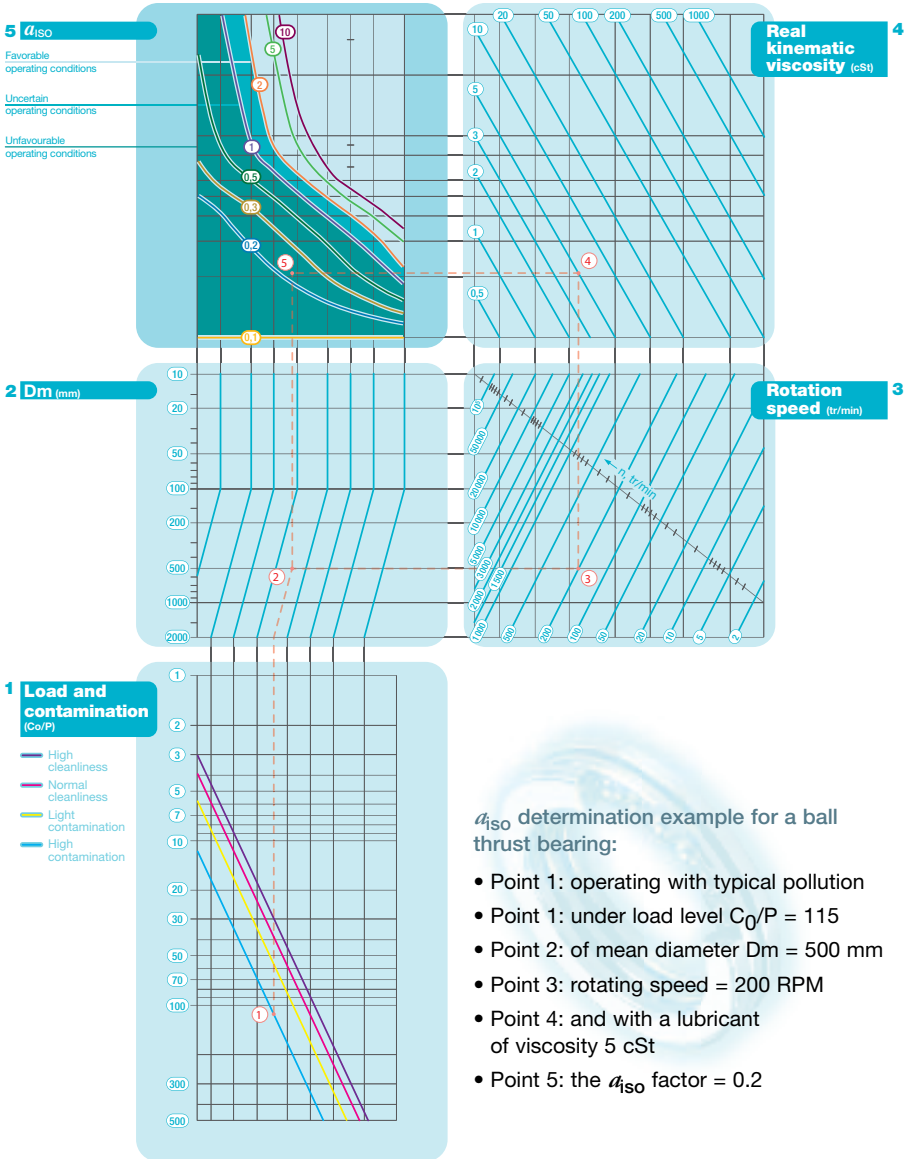

Roller thrust bearings: a_{ISO} factor estimation

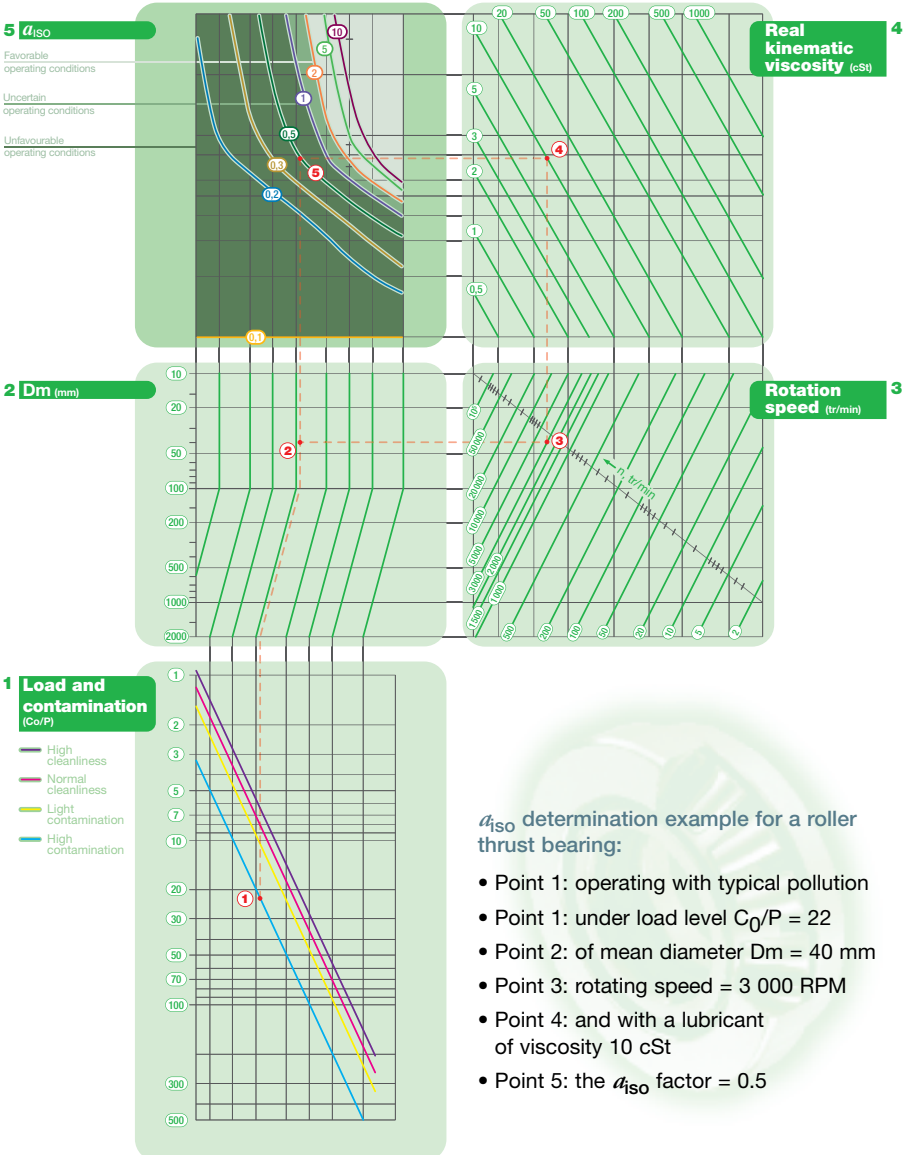

Corrected nominal life (continued)

Bearing reliability

■ As with any material fatigue phenomenon, the occurrence of bearing damage displays a random character.

Thus, identical bearings manufactured from the same batch of material, having identical geometrical characteristics, subjected to identical operating conditions (load, speed, lubrication, etc.) will fail after very different operating times.

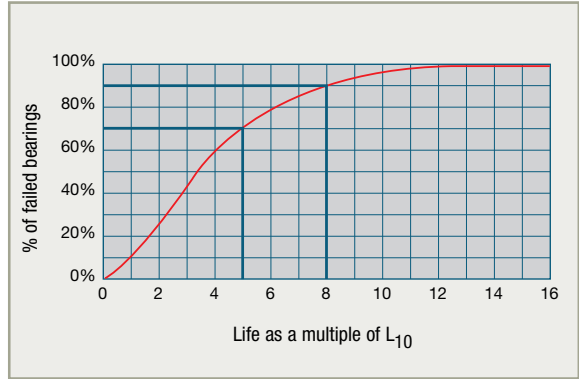

The reference for bearing life is the L_{10} duration which is given for a 90% reliability, or conversely, a 10% probability of failure. It is possible to calculate a service life for a different level of reliability using the factor a_1 , or to find the reliability F for a chosen operating time.

→ Definition of the a_1 factor

■ The reliability value F for an operating time L is expressed mathematically as a function of the reference time L_{10}

$$F = \exp \left(\ln 0.9 \left(L / L_{10} \right)^\beta \right)$$

hence

$$a_1 = (L / L_{10}) = (\ln F / \ln 0.9)^{1/\beta}$$

The correction factor a_1 has been calculated with a straight line of Weibull (see graphic on the next page) $\beta = 1.5$ (mean value for all bearings and thrust bearings).

- These reliability values show the large variation that is characteristic of bearing service lives:
- about 30% of the bearings in a given batch reach a life duration of 5 times the nominal life L_{10}
- about 10% attain a life duration of 8 times the nominal life L_{10} (see graphic above)

In view of this, bearing performance can only be analyzed after several identical tests and only the statistical analysis of the results enables valid conclusions to be drawn.

→ Reliability for a chosen operating time

■ It is often useful to calculate the reliability of a bearing for relatively short operation times, such as the reliability of a component during its warranty period L , knowing the calculated service life L_{10}

The analysis of the results of tests performed by SNR has enabled the plotting of the Weibull line to be improved for short operating times.

Unlike what the previous formulae express (taken into account ISO 281 standard for the calculation of the a_1 factor) there is an operating time value below which the bearing displays no risk of failure (100% reliability). This value is roughly equivalent to 2.5% of the life L_{10} (Figure above: αL_{10}).

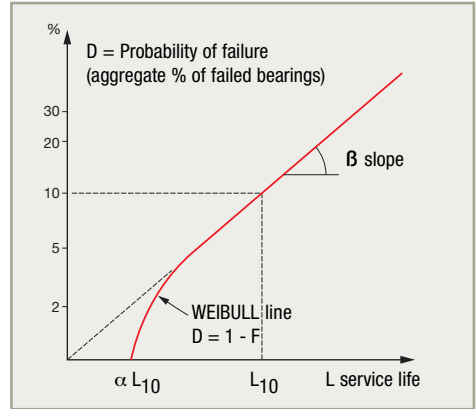

■ To take into account these facts in the reliability calculations for short operating periods, SNR ROULEMENTS uses the previous formula corrected by a factor $\alpha = 0,05$

$$F = \exp \left(\ln 0.9 \left(\left(\frac{L}{L_{10}} - \alpha \right)^\beta (1 - \alpha)^{-\beta} \right) \right)$$

For any reliability F there is a corresponding probability of failure $D = 1 - F$

This probability can be illustrated on a Weibull diagram (in compound logarithmic coordinates) by a straight line with a β slope.

→ Determining a_1 and reliability for a chosen life duration

Reliability 100%	L_{nm}	a_1
90	L_{10m}	1
95	L_{5m}	0.64
96	L_{4m}	0.55
97	L_{3m}	0.47
98	L_{2m}	0.37
99	L_{1m}	0.25
99.2	$L_{0,8m}$	0.22
99.4	$L_{0,6m}$	0.19
99.6	$L_{0,4m}$	0.16
99.8	$L_{0,2m}$	0.12
99.9	$L_{0,1m}$	0.093
99.92	$L_{0,08m}$	0.087
99.94	$L_{0,06m}$	0.080
99.95	$L_{0,05m}$	0.077

Corrected nominal life (continued)

■ Reliability and probability of failure for a chosen duration L

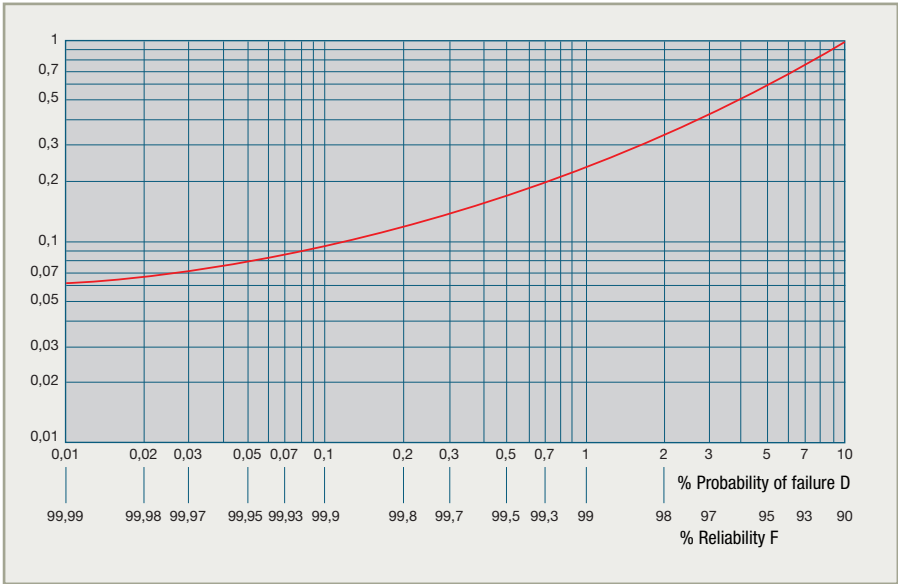

➔ Duration and reliability of a set of bearings

■ According to compound probability theory, the reliability of a set of bearings is the product of the reliabilities of its component bearings.

$$F = F_1 \times F_2 \times \dots$$

■ From the previous formula, the life duration L_{10} of a set is calculated from the duration L_{10} of each of the component bearings.

$$L_e = (1 / L_1^{1,5} + 1 / L_2^{1,5} + \dots)^{-1/1,5}$$

■ Similarly, the probability of failure of a set is, at an initial approximation, the sum of the probabilities of failure of each bearing (for very low failure values).

$$D = D_1 + D_2 + \dots$$

➔ It can be seen that the longer the life of the individual bearings in an assembly, the greater the reliability of that assembly.

Influence of lubrication

The main function of the lubricant is to separate the active surfaces of the bearing by maintaining a film of oil between the rolling elements and their raceways in order to avoid wear and limit abnormal stresses and heating in the metal-on-metal contact area.

The lubricant has two secondary functions: cooling the bearing when the lubricant is oil, and preventing oxidation.

→ Separating power of the lubricant

■ In the area of contact between the rolling elements and the raceway, the Hertz theory can be used to analyse the elastic deformation resulting from the contact pressures.

In spite of these pressures, it is possible to create a film of oil that separates the contacting surfaces. The bearing lubrication system is then characterized by the ratio between the oil film thickness h and the equivalent roughness σ of the surfaces in contact.

$$\sigma = (\sigma_1^2 + \sigma_2^2)^{1/2}$$

σ_1 : mean roughness of the ring raceways

σ_2 : mean roughness of the rolling elements

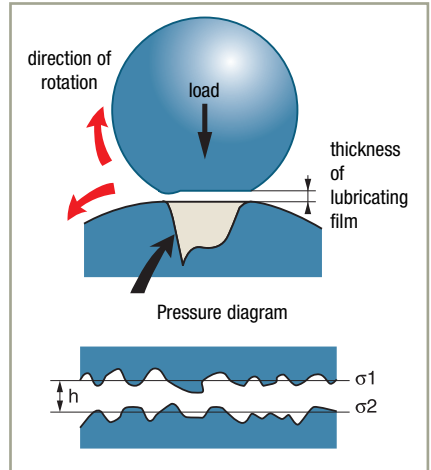

→ Elasto-hydrodynamic theory (EHD)

■ The elasto-hydrodynamic theory takes into account all the parameters involved in the calculation of elastic deformation of the steel and the hydrodynamic pressures of the lubricant, and can be used to evaluate the thickness of the oil film.

These parameters are:

- nature of the lubricant defined by the dynamic viscosity of oil at the operating temperature and its piezoviscosity coefficient which characterizes the increase of viscosity as a function of the contact pressure,
- nature of the materials in contact defined by their E modulus and Poisson ratio, which characterize the amplitude of the deformation at the contact points,
- the load on the most heavily stressed rolling element,
- the speed
- the shape of the contact surfaces defined by their principal crowning radii which characterize the type of bearing used.



Application of the EHD theory to the bearing leads to simplifying hypotheses which show that the thickness of the oil film is virtually solely dependent on the viscosity of the oil and the speed.

Corrected nominal life *(continued)*

Oil lubrication

Tests have shown that the lubrication efficiency defined by the ratio h/σ has a great influence on the effective service life of the bearings. By applying the EHD theory one can check the effect of the lubrication system on bearing life in the diagram of the next page.

Grease lubrication

Application of the EHD theory to lubrication with grease is more complex due to the numerous constituents of the grease. The experimental results rarely show a correlation between the performance and the characteristics of their components. The result is that any recommendation concerning grease is based on tests which are made for a comparative evaluation of the products available on the market. The SNR Research and Test Centre works in close collaboration with the Petroleum Product Research Centres in order to select and develop the highest-performance greases.

→ Determining the minimum required viscosity

Viscosity-temperature diagram

The oils used for the lubrication of bearings are usually mineral oils with a viscosity number of about 90. The suppliers of these oils give the precise characteristics of their products, and in particular the viscosity-temperature diagram.

If this diagram is not provided, the general diagram shown below shall be used.

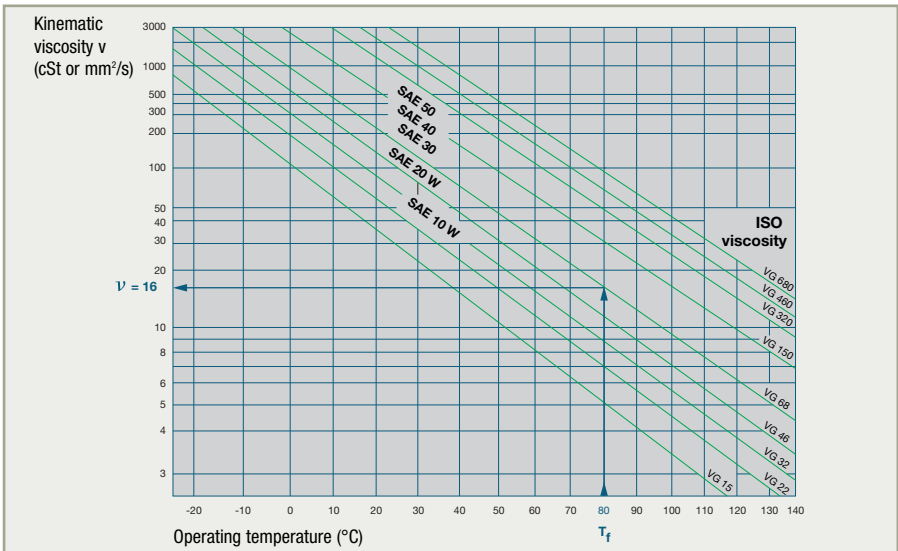

As the oil is defined by its nominal viscosity (in centistokes) at a nominal temperature of 40°C (104°F), its viscosity at the operating temperature is calculated from this.

■ Diagram of the minimum required viscosity

The diagram below can be used to determine the minimum required viscosity (in cSt) from:

- Mean diameter of the bearing $D_m = (D+d)/2$
- Speed of rotation n

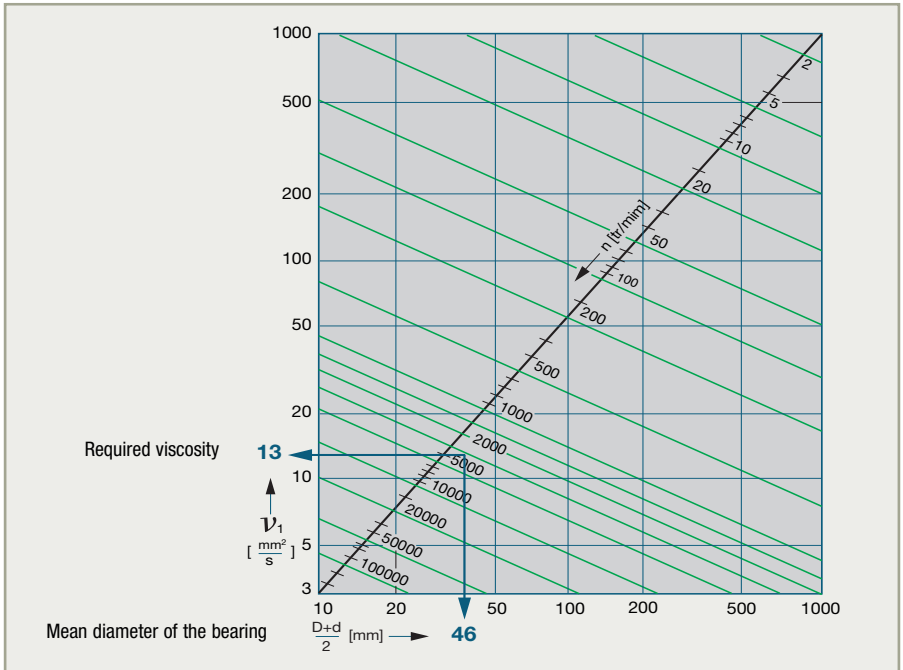

► Example:

Bearing 6206 rotating at 3,000 rpm in a VG68 oil at 80°C (176°F).

The opposite diagram indicates that the actual viscosity of the oil at 80°C (176°F) is 16 cSt.

The above diagram indicates that the required viscosity for a 6206 bearing of average diameter $D_m = (D + d)/2 = 46$ mm at 3,000 rpm is 13 cSt.

Parameters influencing bearing life

Influence of the temperature

→ Normal operating temperatures

■ The normal operating temperature of the bearing is between -20°C (-4°F) and $+120^{\circ}\text{C}$ ($+248^{\circ}\text{F}$)

A temperature outside these operating limits has an effect on:

- the characteristics of the steel
- the internal operating clearance
- the properties of the lubricant
- the efficiency of the seals
- the resistance of synthetic material cages

■ Conditions for bearing operation outside "normal" temperature limits

Continuous operating temperature in $^{\circ}\text{C}$

	-40	-20	0	40	80	120	160	200	240
Steel 100 Cr6	Standard					Reduction in fatigue strength Special heat treatment			
Operating Clearance	Normal					Increased clearance			
Grease	Special low temp.	Standard			Drop in performance	Special high temperature		Dry lubrication	
Seal	Standard (acrylic nitrile)								
	Special (fluoroelastomer)								
Cage	Polyamide 6.6								
	Metallic								

Influence of the operating clearance

→ Radial-contact bearing under radial load

■ The basic dynamic load of a bearing is defined assuming that the radial operating clearance (bearing clearance after fitting) is zero, that is to say that half of the rolling elements are loaded.



■ In practice, the operating clearance is never zero.

- A large clearance (Zone a) causes the load to be supported by a reduced sector of the bearing
- An excessively high preload (Zone b) causes the rolling elements to support a high load in addition to the operating loads.

In both cases the bearing life is reduced, but a preload is more penalizing than a clearance.

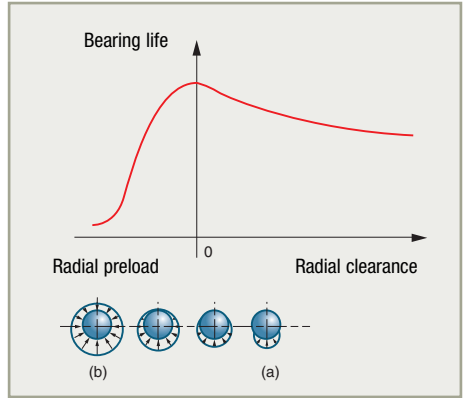

→ Angular contact bearing under radial and axial loads

■ The load zone varies depending on the amount of clearance or preload.



A slight axial preload (Zone c) brings a better load distribution on the rolling elements and increases the bearing life.

It will be noted that a normal axial clearance (Zone a) does not penalize lifetimes very much, while an excessive preload (Zone b) reduces them significantly and causes, in addition to the abnormal stresses, a high rotational torque and a rise of temperature.

This is why the majority of assemblies that do not require a preload have a certain amount of clearance to eliminate these risks and facilitate adjustment and lubrication.

The influence of the clearance on bearing life is calculated from the residual clearance, the size and the direction of the loads applied.

Consult SNR.

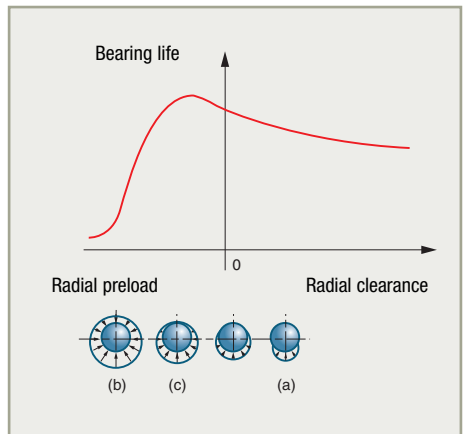

Parameters influencing bearing life *(continued)*

Influence of an excessive load

Under very high loads, corresponding approximately to values $P \geq C / 2$, the stress level in standard steel is such that the formula no longer correctly represents the nominal life with 90% reliability. These high load applications deserve a specific study using our computing resources.

Influence of form and position defects

→ Shape defects

■ The bearing is a precision part and the calculation of its fatigue strength implies having a uniform and continuous distribution of the load between the rolling elements.

If the load distribution is not uniform, the stresses have to be calculated using the finite element method.

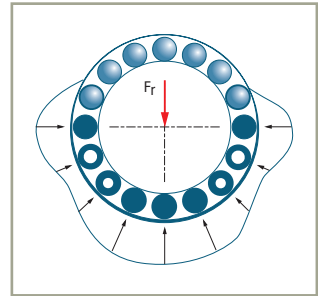

It is important for the bearing seats to be machined with a compatible level of precision. Seat shape defects (ovality, cylindricity defect, etc.) create local stresses that significantly reduce the service life of the bearings. Tables on page 108 give certain tolerance specifications for bearing contact surfaces and seats.

→ Misalignment

■ Misalignment of bearings (very bad for non self-aligning or spherical bearings) results in an angle between the centreline of the inner ring and that of the outer ring.

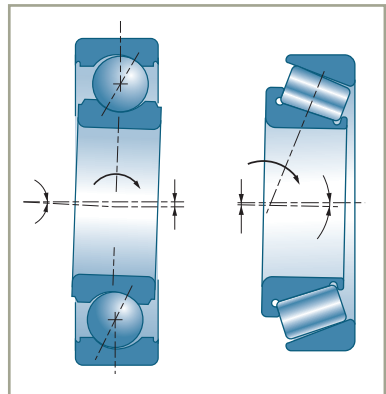

■ Such defects can arise from:

- ▶ a concentricity defect between the two contact surfaces of the shaft or the housings,
- ▶ misalignment between the centreline of the shaft and the centreline of the corresponding housing of a given bearing,
- ▶ a shaft linearity defect,
- ▶ a defect in perpendicularity between the shoulders and the seats.

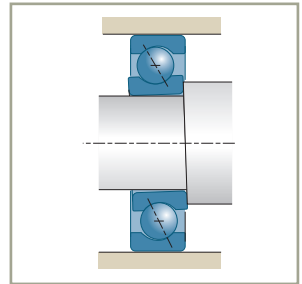
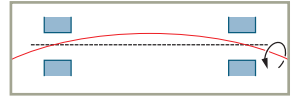
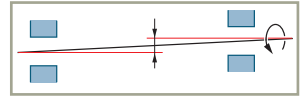

■ The value of these alignment errors and the influence on bearing life is determined by calculation. The diagram below shows the results.

It shows that the drop in service life is very fast and that alignment errors must be kept within very narrow tolerances.

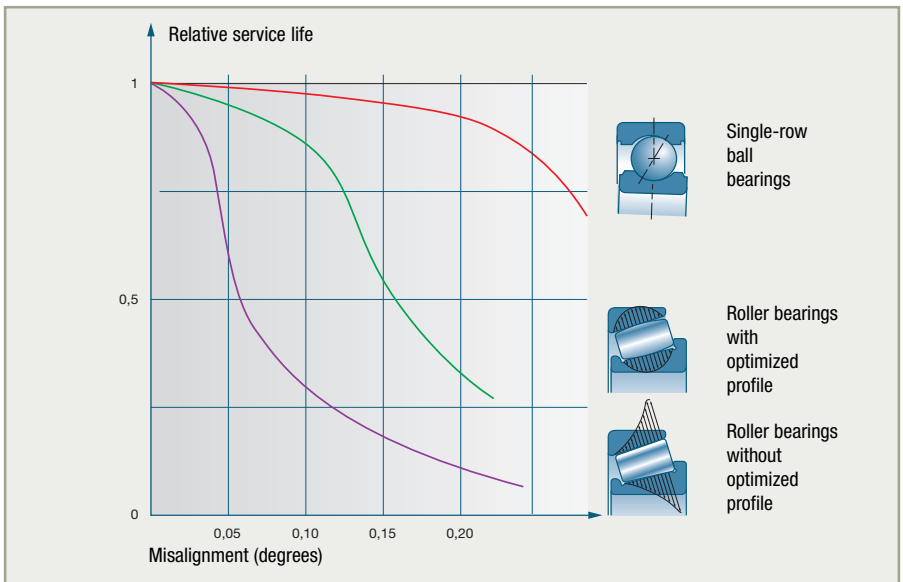

Parameters influencing bearing life *(continued)*

■ Maximum permissible misalignment value with normal operating clearance without significantly penalizing service life.

	$F_a / F_r < e$	$F_a / F_r > e$
Single-row ball bearing	0.17°	0.09°
Double-row rigid ball bearing, Cylindrical or tapered roller bearing	0.06°	0.06°

To reduce the influence of misalignment in single-row ball bearings one can use an increased clearance (category 3).

With cylindrical or tapered roller bearings, SNR makes convex tracks of the rollers which improves the stress distribution in the event of misalignment.

Friction and bearing speed

Friction

■ The friction and consequent heating of a bearing depend on various parameters: the applied load, friction of the cage, internal design of bearing, lubrication, etc.

For the majority of applications below the maximum speed and with non-excessive lubrication, the friction in the bearings can be calculated sufficiently using the following formula:

M_R	Moment of resistance (N.mm)
P_R	Power consumption (W)
F	Radial load for bearings, axial load for thrust bearings (N)
D_m	Mean diameter of bearing $D_m = (d + D) / 2$ (mm)
n	Speed of rotation (min^{-1})
μ	Friction coefficient

$$M_R = \mu \cdot F \cdot D_m / 2$$

$$P_R = M_R \cdot n / 9550$$

Bearings without seals:

Friction coefficient	μ
Radial ball bearings	0,0015
Self-aligning ball bearings	0,0010
Angular contact ball bearing	
• Single-row ball bearing	0,0020
• Double-row ball bearing	0,0024
Ball thrust bearing	0,0013
Cylindrical roller bearing	0,0050
Tapered roller bearing	0,0018
Spherical roller bearing	0,0018

Bearing speed

→ Theory of the Standard ISO 15312

ISO Standard 15312 introduces new concepts concerning bearing speeds:

- Thermal reference speed
- Max. admissible thermal speed
- Limit speed

■ Thermal reference speed. Definition

This is the rotating speed of the inner race for which **thermal balance** is reached **between heat generated by friction in the bearing (N_r) and heat transferred through the bearing seats (shaft and housing) (Φ_r)**. This is valid only in the reference conditions below.

$$N_r = \Phi_r$$

■ Reference conditions determining heat generation by friction

Temperature

- Fixed outer ring temperature $\theta_{r,} = 70^{\circ}\text{C}$
- Ambient temperature $\theta_{Ar} = 20^{\circ}\text{C}$

Load

- Radial bearings: pure radial load corresponding to 5% of basic static radial load.
- Roller thrust bearings: axial load corresponding to 2% of basic static axial load.

Lubricant: mineral oil with extreme pressure additives offering, at $\theta_r = 70^{\circ}\text{C}$, the following kinematic viscosity:

- Radial bearings: $\nu_r = 12 \text{ mm}^2 / \text{s}$ (ISO VG 32)
- Roller thrust bearings: $\nu_r = 24 \text{ mm}^2 / \text{s}$ (ISO VG 68)

Lubrication method: oil bath with oil level up to and including the centre of the rolling body in the lowest position.

Others

- Bearing dimensions: up to and including a bore diameter of 1,000 mm
- Internal play: group "N"
- Seals: bearing without seals
- Bearing rotation axis: horizontal
(For cylindrical roller thrust bearings and needle thrust bearings, take the precaution to supply the upper rolling elements with oil)
- Outer race: fixed
- Preload adjustment in an angular contact bearing: no play in operation

Friction and bearing speed *(continued)*

■ Friction heat, N_r in a bearing operating at thermal reference speed in the reference conditions:

$$N_r = [(\pi \times n_{\theta r}) / (30 \times 10^3)] \times (M_{0r} + M_{1r})$$

M_{0r} : Friction moment, independent from the load

M_{1r} : Friction moment, dependant on the load

$$N_r = [(\pi \times n_{\theta r}) / (30 \times 10^3)] \times [10^{-7} \times f_{0r} \times (v_r \times n_{\theta r})^{2/3} \times d_m^3 + f_{1r} \times P_{1r} \times d_m]$$

f_{0r} : Correction factor for friction moment **independent from the load but dependant on speed** in the reference conditions (values given for information in Appendix A of the Standard)

d_m : Mean bearing diameter $d_m = 0,5 \times (D + d)$

f_{1r} : Correction factor for friction moment **dependent on the load**

P_{1r} : Reference load

■ Reference conditions determining heat emission

Reference surface area, A_r : sum of contact surfaces between races and shaft and housing, through which the thermal flux is emitted.

Reference heat transfer Φ_r : heat generated by the bearing in operation and transmitted by thermal conduction through the reference surface area.

Heat transfer reference density q_r : quotient of reference heat transfer by reference surface area.

■ Heat transfer through seating surfaces

$$\Phi_r = q_r \times A_r$$

■ Max. admissible thermal speed. Definition

A bearing in operation can reach a max. admissible thermal speed which depends on the thermal reference speed. ISO standard 15312 indicates the computation method for this speed.

■ ISO 15312 limit speed. Definition

ISO standard 15312 defines the limit speed of a bearing as the speed which can no longer be sustained by the components.

→ **SNR Theory**

A large majority of bearing applications correspond to speed conditions which are far from critical values. They do not require precise calculations; an indication as to the limit which should not be exceeded is fully sufficient. The definitions and calculation methods developed by the standard ISO 15312 are to be used by specialists who have powerful computing tools, whenever the speed conditions make this calculation indispensable.

This is why, SNR decided to maintain the well tested concept of limit speed in the bearing properties tables.

■ **SNR limit speed. Definition**















This is the maximum speed in normal operating conditions, for which internal heating in the bearing is deemed acceptable.

Said limit speed, defined according to standard concepts, is indicated in the product properties table with a differentiation provided for use with grease or with oil.

Friction and bearing speed *(continued)*

The following table compares the speed capabilities of the different types of bearings.

N.Dm with grease	Types of bearings	N.Dm with oil	
	 Special bearings with appropriate lubrication		Special bearings
1 100 000	 High-precision ball bearings without preload	+ 55%	
650 000	 High-precision ball bearings without preload	+ 55%	
600 000			Standard bearings
550 000	 Single-row radial ball bearings	+ 25%	
500 000	 Self-aligning ball bearings	+ 20%	
450 000	 Cylindrical roller bearings	+ 25%	
400 000	 Single-row angular contact ball bearings	+ 30%	
350 000	 Double-row angular contact ball bearings	+ 30%	
	 Double-row angular contact ball bearings	+ 40%	
300 000	 Spherical roller bearings	+ 35%	
	 Tapered roller bearings	+ 35%	
250 000	 Spherical roller thrust bearings (oil lubrication only)	+ 40%	
200 000			
150 000	 Thrust ball bearings		

Bearing retention and clearances

Bearing retention	90
■ Radial retention	90
■ Axial retention	91
<i>Positioning of single bearing assemblies</i>	91
<i>Positioning of two bearing assemblies</i>	92
■ Axial retention processes	93
Bearing seats	96
■ Bearing tolerances	96
■ Shaft and housing seat tolerances	97
■ Recommended fits	98
■ Value of tolerances and fits	100
■ Geometry and surface conditions of shaft and housing seats	106
Radial clearance of radial contact bearings	109
■ Residual radial clearance : definition, calculation	109
<i>Ratio of interference effect on clearance</i>	109
<i>Residual clearance after fitting: J_{Im}</i>	110
<i>Choice of internal clearance as a function of shaft and housing fits</i>	112
<i>Calculation of residual clearance in operation</i>	112
Axial clearance of angular contact bearings	115
■ Axial preload	115
<i>Axial penetration and prelaod</i>	115
<i>Determining the preload</i>	116
<i>Adjustment</i>	117
■ Theoretical calculation of the variation in the axial clearance of an assembly	117
<i>Modification of clearance on assembly</i>	117
<i>Theoretical calculation of the variation in the axial clearance of an assembly</i>	118

Bearing retention

Radial retention

The bearing rings must be assembled with the mounting elements (shaft and housing) such that they become an integral part of them. The means of connection must prevent any relative movement of the rings on their seat under the radial and axial loads, while maintaining the precision of the bearing, its operating clearance, its limit loads, speed, temperature, etc.

Under the action of the radial load, one of the two rings of a rotating bearing is "rolled" between the rolling elements and its seat, and tends to turn on it. This relative displacement must be prevented to avoid wearing of the seat (bearing hardness: 62 HRC).

■ General rule

The ring that rotates with respect to the load direction must be press fitted on its seat.

	Analysis of rotation (cases frequency)		Retention principle
Load stationary with respect to the outer ring	Stationary housing and load (95 %) Rotating inner ring	Rotating housing and load (0.05 %) Stationary inner ring	Inner ring interference-fitted on shaft
Load stationary with respect to the inner ring	Stationary shaft and load (3 %) Outer ring rotating	Rotating shaft and load (1.5 %) Outer ring stationary	Outer ring interference-fitted in the housing

The bearing rings are usually retained with an interference fit. Other methods of retention do exist as: adapter sleeves (see page 139), eccentric locking collars or set screw on inner ring, gluing, etc. The seat fits are chosen from Standard ISO 286 according to the bearing operating criteria.

Axial retention

The bearings secure the axial positioning of the rotating part of a component with respect to the stationary part.

→ Positioning of single bearing assemblies

■ Retention of bearing assemblies requires one bearing to float axially to prevent stresses due to thermal expansion

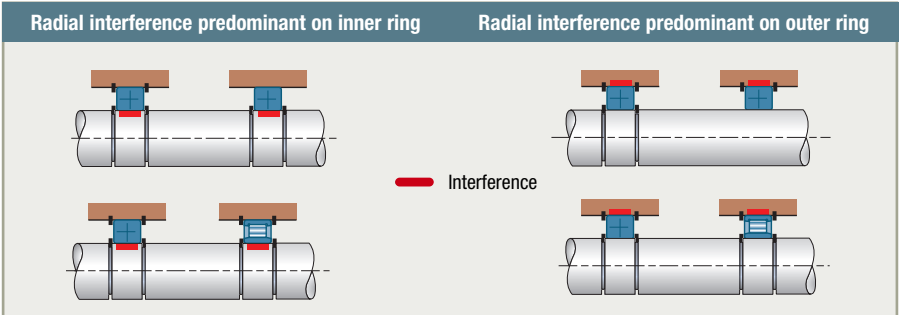

Stationary bearing F

- ▶ the bearing must be positioned by the axial retention of the inner ring and the outer ring
- ▶ possible bearing types

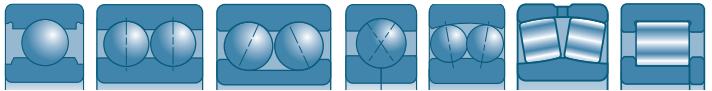

Floating bearing L

- ▶ only the tight fitted ring is axially held, the other is loose
- ▶ possible bearing types

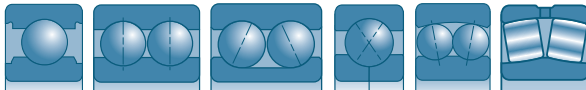

Floating bearing L1

- ▶ with cylindrical roller bearings type N or NU, in which axial mobility is ensured by the bearing itself, the two bearing rings are retained
- ▶ possible bearing types

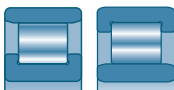

■ Fixed assembly with two bearings

The fixed assembly may be made up of two associated bearings, depending on the assembly specifications.

Bearing retention (continued)

→ Positioning of two bearing assemblies

■ The principle of this assembly is to have one assembly limiting axial displacement of the shaft in one axial direction, while the other assembly limits it in the opposite direction.

This implies that one of the bearing rings must be free to move axially on its seat to permit assembly. The operating axial displacement then depends on the axial adjustment of the relative position of the inner rings with respect to the outer rings.

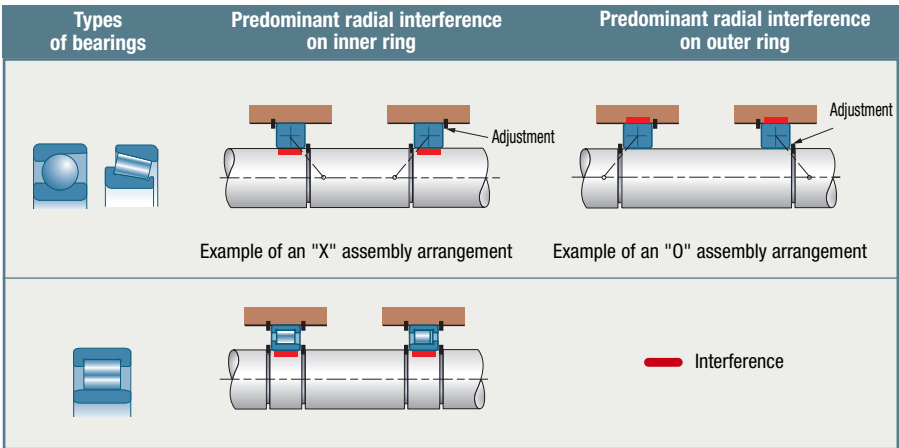

■ Radial contact bearings

This type of assembly can be used with the various types of radial contact bearings: ball bearings, cylindrical roller bearings, self-aligning and spherical bearings. A minimum axial displacement must apply, which varies according to the types of assembly.

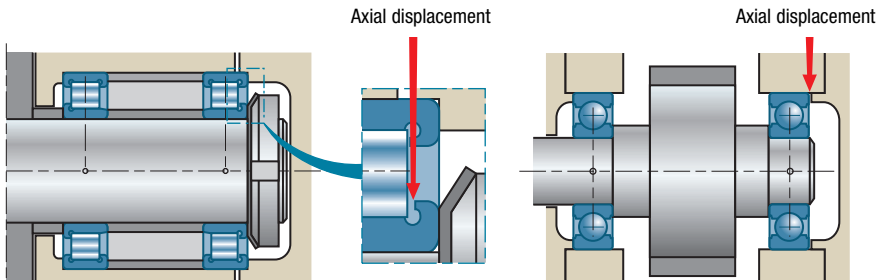

■ Angular contact bearings

Angular contact bearings get their rigidity through their fitting. They have to be adjusted to secure the relative positioning and the operating clearance.

Two types of assembly are possible:

Face-to-face assembly (O): the points of load application are located outside the bearings.

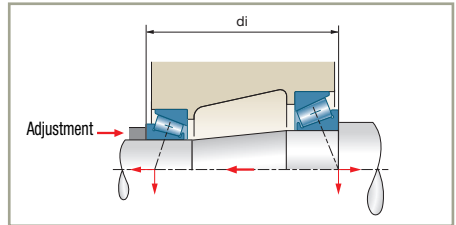

Back-to-back assembly (X): the points of load application are located between the bearings.

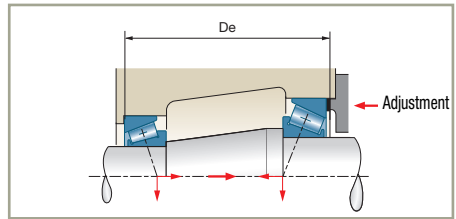

Axial retention processes

■ Inner ring

Nut and washer

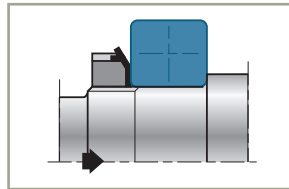

Cylindrical seat.
Tight fit against shoulder.

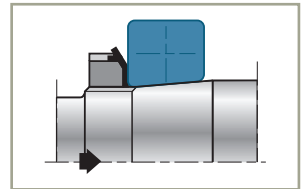

Tapered seat, therefore bearing with tapered bore.
Preferential direction of axial thrust (→).

Snap ring

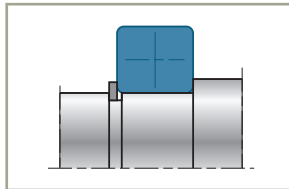

Easy and fast to fit, occupies little space.

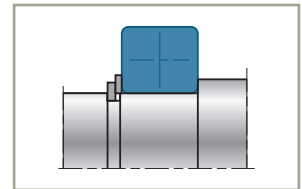

A thrust washer must be installed between the inner ring and the snap ring if axial load is high.

Bearing retention (continued)

Adjusting ring

Reserved for shaft ends.

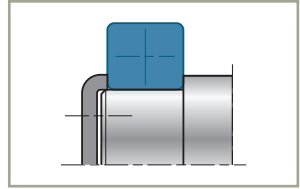

Press fit ring

Preferential direction of axial thrust (→).

The ring has to be destroyed to remove the bearing.

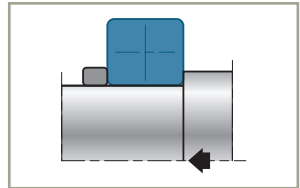

Sleeve

Preferential direction of axial thrust (→).

Does not need precise machining of the shaft.

Above all used for spherical roller bearings.

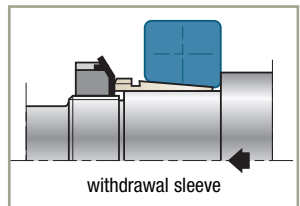
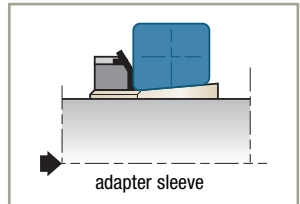

■ Outer ring

Cap

Necessary gap between cap and face of casing.

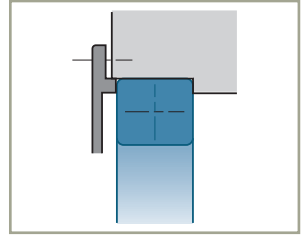

Snap ring

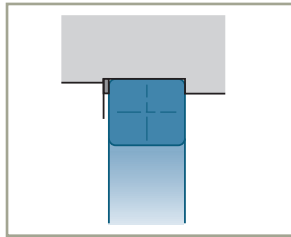

Easy and quick to mount, occupies little space.

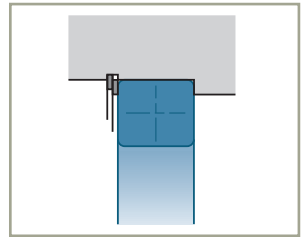

A thrust washer must be installed between the outer ring and the snap ring if axial load is high.

Note : the snap ring (with or without a thrust washer) can replace a shoulder.

Snap ring built in the bearing

(type NR bearing)

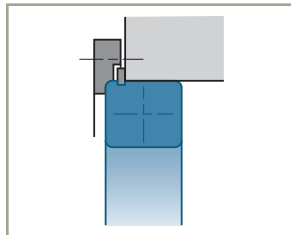

Necessary gap between the cap and the face of the housing.

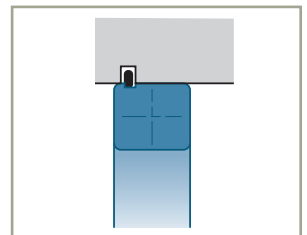

In the particular case where the housing is in two parts, the ring can be installed between the two parts.

Bearing seats

Bearing tolerances

Under the action of the radial load, one of the two rings of a rotating bearing tends to turn. To avoid wearing the seat, this relative displacement must be prevented by having an appropriate fit. The fit of the other ring will allow axial displacement on the seat (adjustment, thermal expansion).

■ Standard precision bearing tolerances

Inner ring

Deviation with respect to the nominal bore

Outer ring

Deviation with respect to the nominal diameter

Bore d	All bearings except tapered roller bearings Δd_{mp} (μm)		Tapered roller bearings Δd_{mp} (μm)	
	max.	min.	max.	min.
2,5 <d≤ 10	0	-8		
10 <d≤ 18	0	-8	0	-12
18 <d≤ 30	0	-10	0	-12
30 <d≤ 50	0	-12	0	-12
50 <d≤ 80	0	-15	0	-15
80 <d≤ 120	0	-20	0	-20
120 <d≤ 180	0	-25	0	-25
180 <d≤ 250	0	-30	0	-30
250 <d≤ 315	0	-35	0	-35
315 <d≤ 400	0	-40	0	-40

Outside diameter D	All bearings except tapered roller bearings ΔD_{mp} (μm)		Tapered roller bearings ΔD_{mp} (μm)	
	max.	min.	max.	min.
6 <D≤ 18	0	-8		
18 <D≤ 30	0	-9	0	-12
30 <D≤ 50	0	-11	0	-14
50 <D≤ 80	0	-13	0	-16
80 <D≤ 120	0	-15	0	-18
120 <D≤ 150	0	-18	0	-20
150 <D≤ 180	0	-25	0	-25
180 <D≤ 250	0	-30	0	-30
250 <D≤ 315	0	-35	0	-35
315 <D≤ 400	0	-40	0	-40
400 <D≤ 500	0	-45	0	-45
500 <D≤ 630	0	-50	0	-50

Other precision classes, see page 23.

Shaft and housing seat tolerances

The shafts are generally machined in tolerances of quality 6 or sometimes 5. The housings, which are more difficult to machine, are usually in quality 7 or sometimes 6 tolerances.

■ Fundamental tolerance values (taken from Standard ISO 286).

Diameter mm	Quality		
	5	6	7
>3 to 6	5	8	12
>6 to 10	6	9	15
>10 to 18	8	11	18
>18 to 30	9	13	21
>30 to 50	11	16	25
>50 to 80	13	19	30
>80 to 120	15	22	35
>120 to 180	18	25	40
>180 to 250	20	29	46
>250 to 315	23	32	52
>315 to 400	25	36	57
>400 to 500	27	40	63

In certain cases, the shape and taper defects in the chosen tolerance interval are unacceptable because they are detrimental to correct bearing operation. In such cases a smaller tolerance interval must be adopted.

Bearing seats (continued)

Recommended fits

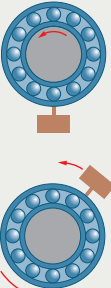
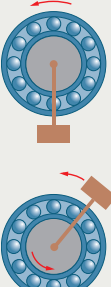
Analysis of rotation	Retention principle	Shaft			Housing		
		Applications	Recommended fits	Examples	Applications	Recommended fits	Examples
The load turns with respect to the outer ring 	Inner ring press fitted on shaft	Normal loads $P < C / 5$	j6 / k6	Electric motors Machine tool spindles Pumps Fans Speed reducers	General case	H7 / J7	Electric motors of moderate power Pulleys Machine-tool spindles Transmissions
		High loads $P > C / 5$	m6 / p6	Traction motors Large speed reducer, compressors			
The load turns with respect to the inner ring 	Outer ring press fitted in housing	General case	g6 / h6	Idler pulleys Tensioners Wheels	Normal loads $P < C / 5$	M7 / N7	Idler pulleys Tensioners Wheels
		Ring floats on its seat	f6 / g6	Axial displacement required (expansion or adjustment)			
Other cases		Purely axial loads	h6 / j6	Bearings and thrust bearings	Purely axial loads	G7 / H7	Bearings and thrust bearings
		Adapter sleeves	h9	Transmissions Agricultural Equipment			

Different choices can be made to take into account various construction and operating factors: for example, if an assembly is subject to vibration and impact, tighter fits must be considered.

Moreover, the type of mounting and the installation procedure can demand different fits. For example, the fit adopted for light alloy housings is usually tighter than those normally specified, to compensate for the differential thermal expansion.

The following tables illustrate the fits used most frequently in the mounting of bearings.
 Example for an SNR 6305 ball bearing (25x62x17)

■ Bearing/housing fit

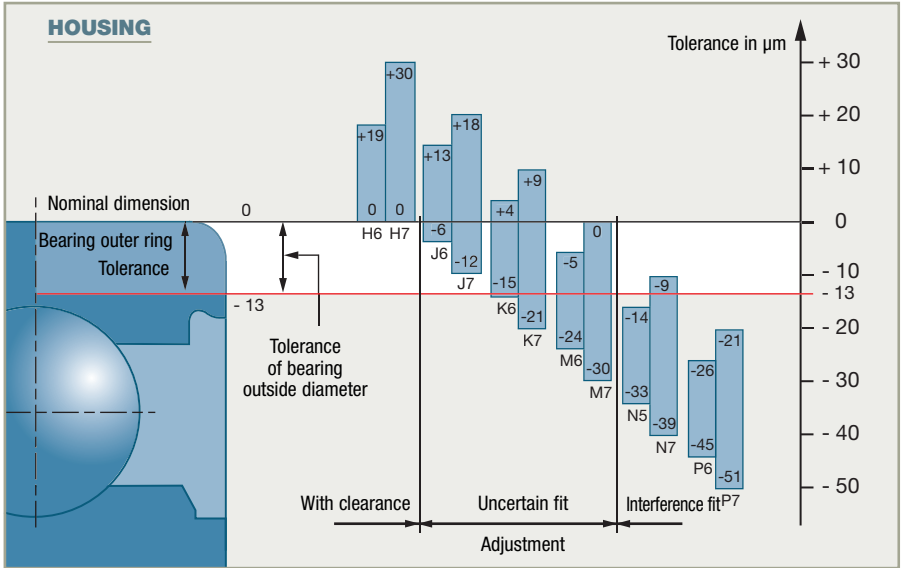

■ Shaft/bearing fit

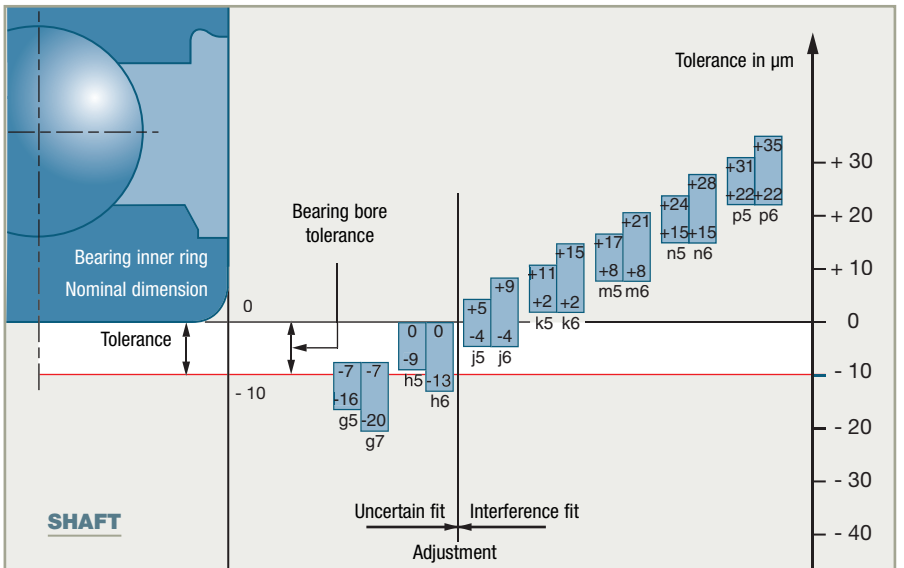

Bearing seats *(continued)*

Value of tolerances and fits

The tables on the following pages indicate:

- the tolerance (in μm) on the bore or outside diameter of the bearing (Standard ISO 492)
- the tolerance (in μm) on the seat diameter according to the chosen fit. (Standard ISO 286)
- the differences (in μm) between the respective diameters of the bearing and its seat:
 - Theoretical values calculated from the extreme bearing and seat tolerance values
 - Mean values
 - Probable values calculated using the Gauss distribution law. (with a probability of 99.7%) from the formula:

$$\text{Probable tol.} = [(\text{Bearing tol.})^2 + (\text{Seat tol.})^2]^{1/2}$$

These tables concern all types of bearings except tapered roller bearings. For tapered roller bearings, use the same calculation procedure but with their specific tolerances.



In practice, one generally only considers the probable tolerance (the risks of error being limited to 0.3%) to determine a realistic value for the probable clearance tolerance of a bearing after fitting.

■ Example

SNR 6305 bearing (25 mm bore).

Fit on shaft k5.

	Tolerance		Mean value	Tolerance interval
	mini	maxi		
Bearing bore	-10	0	-5	10
Shaft tolerance	+2	+11	+6.5	9

- theoretical mean interference = $-(\text{shaft mean val.} - \text{bearing mean val.}) = -[6,5 - (-5)] = -11,5$
- theoretical max. interference = $-(\text{shaft max. val.} - \text{bearing min. val.}) = -[11 - (-10)] = -21$
- theoretical min. interference = $-(\text{shaft min. val.} - \text{bearing max. val.}) = -(2-0) = -2$
- probable tolerance = $[(\text{bearing tol. interval})^2 + (\text{shaft tol. interval})^2]^{1/2} = (10^2 + 9^2)^{1/2} = 13$
- probable max. interference = theoretical mean interference - probable tolerance / 2
 $= -11,5 - 6,5 = -18$
- probable min. interference = theoretical mean interference + probable tolerance / 2
 $= -11,5 + 6,5 = -5$

■ Fits on shaft for normal class bearings (all bearings except tapered roller bearings)

SHAFT																			
Nominal diameter of shaft (mm)	Bearing bore tolerance (µm)		Fits	f5	f6	g5	g6	h5	h6	j5	j6	▼		▼					
3 <d<= 6	-8	0	Shaft tolerances in µm	-15	-10	-10	-9	-4	-12	-4	-5	0	-8	0	1	+4	-1	+7	
			Mean	+8.5	+10	+10	-2.5	+4	+1.5	0	-1.5	0	-1	-5.5	-7				
			Probable difference in diameters	+13	+4	+15.5	+4.5	+7	-2	+9.5	-1.5	+3	-6	+5.5	-5.5	-10	-1.5	-12.5	
6 <d<= 10	-8	0	Shaft tolerances in µm	-19	-13	-22	-13	-11	-5	-14	-5	-6	0	-9	0	-2	+4	-2	+7
			Mean	+12	+13.5	+4	+5.5	-1	+0.5	0	-5	-6.5	-5.5	0	-10	-0.5	-12.5		
			Probable difference in diameters	+17	+7	+19.5	+7.5	+9	-1	+11.5	-0.5	+4	-6	+6.5	-5.5	0	-10	-0.5	-12.5
10 <d<= 18	-8	0	Shaft tolerances in µm	-24	-16	-27	-16	-14	-6	-17	-6	-8	0	-11	0	-3	+5	-3	+8
			Mean	+16	+17.5	+6	+7.5	0	+1.5	0	-5	-5	-5	-5	-5	-6.5			
			Probable difference in diameters	+21.5	+10.5	+24.5	+10.5	+11.5	+0.5	+14.5	+0.5	+5.5	-5.5	+8.5	-5.5	+0.5	-10.5	+0.5	-13.5
18 <d<= 30	-10	0	Shaft tolerances in µm	-29	-20	-33	-20	-16	-7	-20	-7	-9	0	-13	0	-4	+5	-4	+9
			Mean	+19.5	+21.5	+6.5	+8.5	-0.5	+1.5	0	-5.5	-5.5	-5.5	-5.5	-7.5				
			Probable difference in diameters	+26	+13	+30	+13	+13	0	+17	0	+6	-7	+10	-7	+1	-12	+1	-16
30 <d<= 50	-12	0	Shaft tolerances in µm	-36	-25	-41	-25	-20	-9	-25	-9	-11	0	-16	0	-5	+6	-5	+11
			Mean	+24.5	+27	+8.5	+11	+1	-0.5	+2	0	-6.5	-6.5	-9					
			Probable difference in diameters	+32.5	+16.5	+37	+17	+16.5	+0.5	+21	+1	+7.5	-8.5	+12	-8	+1.5	-14.5	+1	-19
50 <d<= 65	-15	0	Shaft tolerances in µm	-43	-30	-49	-30	-23	-10	-29	-10	-13	0	-19	0	-7	+6	-7	+12
			Mean	+29	+32	+9	+12	-1	+2	0	-7	-7	-7	-10					
			Probable difference in diameters	+39	+19	+44	+20	+19	-1	+24	0	+9	-11	+14	-10	+3	-17	+2	-22
65 <d<= 80	-15	0	Shaft tolerances in µm	-43	-30	-49	-30	-23	-10	-29	-10	-13	0	-19	0	-7	+6	-7	+12
			Mean	+29	+32	+9	+12	-1	+2	0	-7	-7	-7	-10					
			Probable difference in diameters	+39	+19	+44	+20	+19	-1	+24	0	+9	-11	+14	-10	+3	-17	+2	-22
80 <d<= 100	-20	0	Shaft tolerances in µm	-51	-36	-58	-36	-27	-12	-34	-12	-15	0	-22	0	-9	+6	-9	+13
			Mean	+33.5	+37	+9.5	+13	-2.5	+1	0	-8.5	-12							
			Probable difference in diameters	+46	+21	+52	+22	+22	-3	+28	-2	+10	-15	+16	-14	+4	-21	+3	-27
100 <d<= 120	-20	0	Shaft tolerances in µm	-51	-36	-58	-36	-27	-12	-34	-12	-15	0	-22	0	-9	+6	-9	+13
			Mean	+33.5	+37	+9.5	+13	-2.5	+1	0	-8.5	-12							
			Probable difference in diameters	+46	+21	+52	+22	+22	-3	+28	-2	+10	-15	+16	-14	+4	-21	+3	-27
120 <d<= 140	-25	0	Shaft tolerances in µm	-61	-43	-68	-43	-32	-14	-39	-14	-18	0	-25	0	-11	+7	-11	+14
			Mean	+39.5	+43	+10.5	+14	-3.5	0	-10.5	-14								
			Probable difference in diameters	+55	+24	+60.5	+25.5	+26	-5	+31.5	-3.5	+12	-19	+17.5	-17.5	+5	-26	+4	-32
140 <d<= 160	-25	0	Shaft tolerances in µm	-61	-43	-68	-43	-32	-14	-39	-14	-18	0	-25	0	-11	+7	-11	+14
			Mean	+39.5	+43	+10.5	+14	-3.5	0	-10.5	-14								
			Probable difference in diameters	+55	+24	+60.5	+25.5	+26	-5	+31.5	+3.5	+12	-19	+17.5	-17.5	+5	-26	+4	-32
160 <d<= 180	-25	0	Shaft tolerances in µm	-61	-43	-68	-43	-32	-14	-39	-14	-18	0	-25	0	-11	+7	-11	+14
			Mean	+39.5	+43	+10.5	+14	-3.5	0	-10.5	-14								
			Probable difference in diameters	+55	+24	+60.5	+25.5	+26	-5	+31.5	-3.5	+12	-19	+17.5	-17.5	+5	-26	+4	-32
180 <d<= 200	-30	0	Shaft tolerances in µm	-70	-50	-79	-50	-35	-15	-44	-15	-20	0	-29	0	-13	+7	-13	+16
			Mean	+45	+49.5	+10	+14.5	-5	-0.5	-12	-16.5								
			Probable difference in diameters	+63	+27	+70.5	+28.5	+28	-8	+35.5	-6.5	+13	-23	+20.5	-21.5	+6	-30	+4.5	-37.5
200 <d<= 225	-30	0	Shaft tolerances in µm	-70	-50	-79	-50	-35	-15	-44	-15	-20	0	-29	0	-13	+7	-13	+16
			Mean	+45	+49.5	+10	+14.5	-5	-0.5	-12	-16.5								
			Probable difference in diameters	+63	+27	+70.5	+28.5	+28	-8	+35.5	-6.5	+13	-23	+20.5	-21.5	+6	-30	+4.5	-37.5
225 <d<= 250	-30	0	Shaft tolerances in µm	-70	-50	-79	-50	-35	-15	-44	-15	-20	0	-29	0	-13	+7	-13	+16
			Mean	+45	+49.5	+10	+14.5	-5	-0.5	-12	-16.5								
			Probable difference in diameters	+63	+27	+70.5	+28.5	+28	-8	+35.5	-6.5	+13	-23	+20.5	-21.5	+6	-30	+4.5	-37.5
250 <d<= 280	-35	0	Shaft tolerances in µm	-79	-56	-88	-56	-40	-17	-49	-17	-23	0	-32	0	-16	+7	-16	+16
			Mean	+50	+54.5	+11	+15.5	-6	-1.5	-13	-17.5								
			Probable difference in diameters	+71	+29	+78	+31	+32	-10	+39	-8	+15	-27	+22	-25	+8	-34	+6	-41
280 <d<= 315	-35	0	Shaft tolerances in µm	-79	-56	-88	-56	-40	-17	-49	-17	-23	0	-32	0	-16	+7	-16	+16
			Mean	+50	+54.5	+11	+15.5	-6	-1.5	-13	-17.5								
			Probable difference in diameters	+71	+29	+78	+31	+32	-10	+39	-8	+15	-27	+22	-25	+8	-34	+6	-41
315 <d<= 400	-40	0	Shaft tolerances in µm	-87	-62	-98	-62	-43	-18	-54	-18	-25	0	-36	0	-18	+7	-18	+18
			Mean	+57	+62.5	+13	+18.5	-7	-2	-15	-20								
			Probable difference in diameters	+79	+35	+88	+37	+35	-9	+44	-7	+17	-27	+26	-25	+10	-34	+8	-43
400 <d<= 500	-45	0	Shaft tolerances in µm	-95	-68	-108	-68	-47	-20	-60	-20	-27	0	-40	0	-20	+7	-20	+20
			Mean	+64	+70.5	+16	+22.5	-4	+2.5	-11	-17.5								
			Probable difference in diameters	+86	+42	+97	+44	+38	-6	+49	-4	+18	-26	+29	-24	+11	-33	+9	-44
500 <d<= 630	-50	0	Shaft tolerances in µm		-120	-76			-66	-22	-32	0	-44	0					
			Mean		+80.5	+26.5	+1.5	+4.5											
			Probable difference in diameters		+109	+52			+55	-2	+22	-25	+33	-24					
630 <d<= 800	-75	0	Shaft tolerances in µm		-130	-80			-74	-24	-36	0	-50	0					
			Mean		+87.5	+31.5	+0.5	+7.5											
			Probable difference in diameters		+118	+57			+62	+1	+26	-25	+38	-23					

1. A negative value denotes an interference fit and a positive value a loose fit
2. The probable fit values are calculated on the assumption that the statistical distribution of the dimensions within the tolerances follows a "normal" law (Gauss distribution law)
3. Bearing tolerances and fits: values in microns (µm)
4. ▼ The most common fits

■ Fits on shaft for normal class bearings (all bearings except tapered roller bearings)

SHAFT											
Nominal diameter of shaft (mm)	Bearing bore tolerance (µm)	Fits	k5	k6	m5	m6	n5	n6	p5	p6	
3 <d _s 6	-8 0	Shaft tolerances in µm	+1 +6	+1 +9	+4 +9	+4 +12	+8 +13	+8 +16	+12 +17	+12 +20	
		Mean	-7.5	-9	-10.5	-12	-14.5	-16	-18.5	-20	
		Probable difference in diameters	-3 -12	-3.5 -14.5	-6 -15	-6.5 -17.5	-10 -19	-10.5 -21.5	-14 -23	-14.5 -25.5	
6 <d _s 10	-8 0	Shaft tolerances in µm	+1 +7	+1 +10	+8 +12	+6 +15	+10 +16	+10 +19	+15 +21	+15 +24	
		Mean	-8	-9.5	-13	-14.5	-17	-18.5	-22	-23.5	
		Probable difference in diameters	-3 -13	-3.5 -15.5	-8 -18	-8.5 -20.5	-12 -22	-12.5 -24.5	-17 -27	-17.5 -29.5	
10 <d _s 18	-8 0	Shaft tolerances in µm	+1 +9	+1 +12	+7 +15	+7 +18	+12 +20	+12 +23	+18 +26	+18 +29	
		Mean	-9	-10.5	-15	-16.5	-20	-21.5	-26	-27.5	
		Probable difference in diameters	-3.5 -14.5	-3.5 -17.5	-9.5 -20.5	-9.5 -23.5	-14.5 -25.5	-14.5 -28.5	-20.5 -31.5	-20.5 -34.5	
18 <d _s 30	-10 0	Shaft tolerances in µm	+2 +11	+2 +15	+8 +17	+8 +21	+15 +24	+15 +28	+22 +31	+22 +35	
		Mean	-11.5	-13.5	-17.5	-19.5	-24.5	-26.5	-31.5	-33.5	
		Probable difference in diameters	-5 -18	-5 -22	-11 -24	-11 -28	-18 -31	-18 -35	-25 -38	-25 -42	
30 <d _s 50	-12 0	Shaft tolerances in µm	+2 +13	+2 +18	+9 +20	+9 +25	+17 +28	+17 +33	+26 +37	+26 +42	
		Mean	-13.5	-16	-20.5	-23	-28.5	-31	-37.5	-40	
		Probable difference in diameters	-5.5 -21.5	-6 -26	-12.5 -28.5	-13 -33	-20.5 -36.5	-21 -41	-29.5 -45.5	-30 -50	
50 <d _s 65	-15 0	Shaft tolerances in µm	+2 +15	+2 +21	+11 +24	+11 +30	+20 +33	+20 +39	+32 +45	+32 +51	
		Mean	-16	-19	-25	-28	-34	-37	-46	-49	
		Probable difference in diameters	-6 -26	-7 -31	-15 -35	-16 -40	-24 -44	-25 -49	-36 -56	-37 -61	
65 <d _s 80	-15 0	Shaft tolerances in µm	+2 +15	+2 +21	+11 +24	+11 +30	+20 +33	+20 +39	+32 +45	+32 +51	
		Mean	-16	-19	-25	-28	-34	-37	-46	-49	
		Probable difference in diameters	-6 -26	-7 -31	-15 -35	-16 -40	-24 -44	-25 -49	-36 -56	-37 -61	
80 <d _s 100	-20 0	Shaft tolerances in µm	+3 +18	+3 +25	+13 +28	+13 +35	+23 +38	+23 +45	+37 +52	+37 +59	
		Mean	-20.5	-24	-30.5	-34	-40.5	-44	-54.5	-58	
		Probable difference in diameters	-8 -33	-9 -39	-18 -43	-19 -49	-28 -53	-29 -59	-42 -67	-43 -73	
100 <d _s 120	-20 0	Shaft tolerances in µm	+3 +18	+3 +25	+13 +28	+13 +35	+23 +38	+23 +45	+37 +52	+37 +59	
		Mean	-20.5	-24	-30.5	-34	-40.5	-44	-54.5	-58	
		Probable difference in diameters	-8 -33	-9 -39	-18 -43	-19 -49	-28 -53	-29 -59	-42 -67	-43 -73	
120 <d _s 140	-25 0	Shaft tolerances in µm	+3 +21	+3 +28	+15 +33	+15 +40	+27 +45	+27 +52	+43 +61	+43 +68	
		Mean	-24.5	-28	-36.5	-40	-48.5	-52	-64.5	-68	
		Probable difference in diameters	-9 -40	-10.5 -45.5	-21 -52	-22.5 -57.5	-33 -64	-34.5 -69.5	-49 -80	-50.5 -85.5	
140 <d _s 160	-25 0	Shaft tolerances in µm	+3 +21	+3 +28	+15 +33	+15 +40	+27 +45	+27 +52	+43 +61	+43 +68	
		Mean	-24.5	-28	-36.5	-40	-48.5	-52	-64.5	-68	
		Probable difference in diameters	-9 -40	-10.5 -45.5	-21 -52	-22.5 -57.5	-33 -64	-34.5 -69.5	-49 -80	-50.5 -85.5	
160 <d _s 180	-25 0	Shaft tolerances in µm	+3 +21	+3 +28	+15 +33	+15 +40	+27 +45	+27 +52	+43 +61	+43 +68	
		Mean	-24.5	-28	-36.5	-40	-48.5	-52	-64.5	-68	
		Probable difference in diameters	-9 -40	-10.5 -45.5	-21 -52	-22.5 -57.5	-33 -64	-34.5 -69.5	-49 -80	-50.5 -85.5	
180 <d _s 200	-30 0	Shaft tolerances in µm	+4 +24	+4 +33	+17 +37	+17 +46	+31 +51	+31 +60	+50 +70	+50 +79	
		Mean	-29	-33.5	-42	-46.5	-56	-60.5	-75	-79.5	
		Probable difference in diameters	-11 -47	-12.5 -54.5	-24 -60	-25.5 -67.5	-38 -74	-39.5 -81.5	-57 -93	-58.5 -100.5	
200 <d _s 225	-30 0	Shaft tolerances in µm	+4 +24	+4 +33	+17 +37	+17 +46	+31 +51	+31 +60	+50 +70	+50 +79	
		Mean	-29	-33.5	-42	-46.5	-56	-60.5	-75	-79.5	
		Probable difference in diameters	-11 -47	-12.5 -54.5	-24 -60	-25.5 -67.5	-38 -74	-39.5 -81.5	-57 -93	-58.5 -100.5	
225 <d _s 250	-30 0	Shaft tolerances in µm	+4 +24	+4 +33	+17 +37	+17 +46	+31 +51	+31 +60	+50 +70	+50 +79	
		Mean	-29	-33.5	-42	-46.5	-56	-60.5	-75	-79.5	
		Probable difference in diameters	-11 -47	-12.5 -54.5	-24 -60	-25.5 -67.5	-38 -74	-39.5 -81.5	-57 -93	-58.5 -100.5	
250 <d _s 280	-35 0	Shaft tolerances in µm	+4 +27	+4 +36	+20 +43	+20 +52	+34 +57	+34 +66	+56 +79	+56 +88	
		Mean	-33	-37.5	-49	-53.5	-63	-67.5	-84	-89.5	
		Probable difference in diameters	-12 -54	-14 -61	-28 -70	-30 -77	-42 -84	-44 -91	-64 -106	-66 -113	
280 <d _s 315	-35 0	Shaft tolerances in µm	+4 +27	+4 +36	+20 +43	+20 +52	+34 +57	+34 +66	+56 +79	+56 +88	
		Mean	-33	-37.5	-49	-53.5	-63	-67.5	-84	-89.5	
		Probable difference in diameters	-12 -54	-14 -61	-28 -70	-30 -77	-42 -84	-44 -91	-64 -106	-66 -113	
315 <d _s 400	-40 0	Shaft tolerances in µm	+4 +29	+4 +40	+21 +46	+21 +57	+37 +62	+37 +73	+62 +87	+62 +98	
		Mean	-34	-39.5	-51	-56.5	-67	-72.5	-92	-97.5	
		Probable difference in diameters	-12 -56	-14 -65	-29 -73	-31 -82	-45 -89	-47 -98	-70 -114	-72 -123	
400 <d _s 500	-45 0	Shaft tolerances in µm	+5 +32	+5 +45	+23 +50	+23 +63	+40 +67	+40 +80	+68 +95	+68 +108	
		Mean	-36	-42.5	-54	-60.5	-71	-77.5	-99	-105.5	
		Probable difference in diameters	-14 -58	-16 -69	-32 -76	-34 -87	-49 -93	-51 -104	-77 -121	-79 -132	
500 <d _s 630	-50 0	Shaft tolerances in µm		0 +44		+26 +70		+44 +88		+78 +122	
		Mean		-39.5		-65.5		-83.5		-117.5	
		Probable difference in diameters		-11 -68		-37 -94		-55 -112		-89 -146	
630 <d _s 800	-75 0	Shaft tolerances in µm		0 +50		+30 +80		+50 +100		+88 +138	
		Mean		-42.5		-72.5		-92.5		-130.5	
		Probable difference in diameters		-12 -73		-42 -103		-62 -123		-100 -161	

1. A negative value denotes an interference fit and a positive value a loose fit
2. The probable fit values are calculated on the assumption that the statistical distribution of the dimensions within the tolerances follows a "normal" law (Gauss distribution law)
3. Bearing tolerances and fits: values in microns (µm)
4. ▼ The most common fits



Bearing retention and clearances

■ Fits in the housings for normal class bearings (all bearings except tapered roller bearings)

HOUSING												
Nominal diameter of housing (mm)	Tolerance on outside diameter (µm)	Fits		G6	G7	H6	H7	J6	J7	K6	K7	
		Mean	Probable difference in diameters									
10 <D _s 18	-8 0	Housing tolerance	+6 +17	+6 +24	0 +11	0 +18	-5 +6	-8 +10	-9 +2	-12 +6		
		Mean	+15.5	+19	+9.5	+13	+4.5	+5	+0.5	+1		
		Probable difference in diameters	+22.5 +8.5	+29 +9	+16.5 +2.5	+23 +3	+11.5 -2.5	+15 -5	+7.5 -6.5	+11 -9		
18 <D _s 30	-9 0	Housing tolerance	+7 +20	+7 +28	0 +13	0 +21	-5 +8	-9 +12	-11 +2	-15 +6		
		Mean	+18	+22	+11	+15	+6	+6	0	0		
		Probable difference in diameters	+26 +10	+33.5 +10.5	+19 +3	+26.5 +3.5	+14 -2	+17.5 -5.5	+8 -8	+11.5 -11.5		
30 <D _s 50	-11 0	Housing tolerance	+9 +25	+9 +34	0 +16	0 +25	-6 +10	-11 +14	-13 +3	-18 +7		
		Mean	+22.5	+27	+13.5	+18	+7.5	+7	+0.5	0		
		Probable difference in diameters	+32 +13	+40.5 +13.5	+23 +4	+31.5 +4.5	+17 -2	+20.5 -6.5	+10 -9	+13.5 -13.5		
50 <D _s 65	-13 0	Housing tolerance	+10 +29	+10 +40	0 +19	0 +30	-6 +13	-12 +18	-15 +4	-21 +9		
		Mean	+26	+31.5	+16	+21.5	+10	+9.5	+1	+0.5		
		Probable difference in diameters	+37.5 +14.5	+48 +15	+27.5 +4.5	+38 +5	+21.5 -1.5	+26 -7	+12.5 -10.5	+17 -16		
65 <D _s 80	-13 0	Housing tolerance	+10 +29	+10 +40	0 +19	0 +30	-6 +13	-12 +18	-15 +4	-21 +9		
		Mean	+26	+31.5	+16	+21.5	+10	+9.5	+1	+0.5		
		Probable difference in diameters	+37.5 +14.5	+48 +15	+27.5 +4.5	+38 +5	+21.5 -1.5	+26 -7	+12.5 -10.5	+17 -16		
80 <D _s 100	-15 0	Housing tolerance	+12 +34	+12 +47	0 +22	0 +35	-6 +16	-13 +22	-18 +4	-25 +10		
		Mean	+30.5	+37	+18.5	+25	+12.5	+12	+0.5	0		
		Probable difference in diameters	+44 +17	+56 +18	+32 +5	+44 +6	+26 -1	+31 -7	+14 -13	+19 -19		
100 <D _s 120	-15 0	Housing tolerance	+12 +34	+12 +47	0 +22	0 +35	-6 +16	-13 +22	-18 +4	-25 +10		
		Mean	+30.5	+37	+18.5	+25	+12.5	+12	+0.5	0		
		Probable difference in diameters	+44 +17	+56 +18	+32 +5	+44 +6	+26 -1	+31 -7	+14 -13	+19 -19		
120 <D _s 140	-18 0	Housing tolerance	+14 +39	+14 +54	0 +25	0 +40	-7 +18	-14 +26	-21 +4	-28 +12		
		Mean	+35.5	+43	+21.5	+29	+14.5	+15	+0.5	+1		
		Probable difference in diameters	+51 +20	+65 +21	+37 +6	+51 +7	+30 -1	+37 -7	+16 -15	+23 -21		
140 <D _s 150	-18 0	Housing tolerance	+14 +39	+14 +54	0 +25	0 +40	-7 +18	-14 +26	-21 +4	-28 +12		
		Mean	+35.5	+43	+21.5	+29	+14.5	+15	+0.5	+1		
		Probable difference in diameters	+51 +20	+65 +21	+37 +6	+51 +7	+30 -1	+37 -7	+16 -15	+23 -21		
150 <D _s 160	-25 0	Housing tolerance	+14 +39	+14 +54	0 +25	0 +40	-7 +18	-14 +26	-21 +4	-28 +12		
		Mean	+39	+46.5	+25	+32.5	+18	+18.5	+4	+4.5		
		Probable difference in diameters	+56.5 +21.5	+70 +23	+42.5 +7.5	+56 +9	+35.5 +0.5	+42 -5	+21.5 -13.5	+28 -19		
160 <D _s 180	-25 0	Housing tolerance	+14 +39	+14 +54	0 +25	0 +40	-7 +18	-14 +26	-21 +4	-28 +12		
		Mean	+39	+46.5	+25	+32.5	+18	+18.5	+4	+4.5		
		Probable difference in diameters	+56.5 +21.5	+70 +23	+42.5 +7.5	+56 +9	+35.5 +0.5	+42 -5	+21.5 -13.5	+28 -19		
180 <D _s 200	-30 0	Housing tolerance	+15 +44	+15 +61	0 +29	0 +46	-7 +22	-16 +30	-24 +5	-33 +13		
		Mean	+44.5	+53	+29.5	+38	+22.5	+22	+5.5	+5		
		Probable difference in diameters	+65.5 +23.5	+80.5 +25.5	+50.5 +2.5	+65.5 +10.5	+43.5 -1.5	+49.5 -5.5	+26.5 -15.5	+32.5 -22.5		
200 <D _s 225	-30 0	Housing tolerance	+15 +44	+15 +61	0 +29	0 +46	-7 +22	-16 +30	-24 +5	-33 +13		
		Mean	+44.5	+53	+29.5	+38	+22.5	+22	+5.5	+5		
		Probable difference in diameters	+65.5 +23.5	+80.5 +25.5	+50.5 +8.5	+65.5 +10.5	+43.5 +1.5	+49.5 -5.5	+26.5 -15.5	+32.5 -22.5		
225 <D _s 250	-30 0	Housing tolerance	+15 +44	+15 +61	0 +29	0 +46	-7 +22	-16 +30	-24 +5	-33 +13		
		Mean	+44.5	+53	+29.5	+38	+22.5	+22	+5.5	+5		
		Probable difference in diameters	+65.5 +23.5	+80.5 +25.5	+50.5 +8.5	+65.5 +10.5	+43.5 +1.5	+49.5 -5.5	+26.5 -15.5	+32.5 -22.5		
250 <D _s 280	-35 0	Housing tolerance	+17 +49	+17 +69	0 +32	0 +52	-7 +25	-16 +36	-27 +5	-36 +16		
		Mean	+50.5	+60.5	+33.5	+43.5	+26.5	+27.5	+6.5	+7.5		
		Probable difference in diameters	+74 +27	+92 +29	+57 +10	+75 +12	+50 +3	+59 -4	+30 -17	+39 -24		
280 <D _s 315	-35 0	Housing tolerance	+17 +49	+17 +69	0 +32	0 +52	-7 +25	-16 +36	-27 +5	-36 +16		
		Mean	+50.5	+60.5	+33.5	+43.5	+26.5	+27.5	+6.5	+7.5		
		Probable difference in diameters	+74 +27	+92 +29	+57 +10	+75 +12	+50 +3	+59 -4	+30 -17	+39 -24		
315 <D _s 400	-40 0	Housing tolerance	+18 +54	+18 +75	0 +36	0 +57	-7 +29	-18 +39	-29 +7	-40 +17		
		Mean	+53.5	+64	+36.5	+46	+28.5	+28	+6.5	+6		
		Probable difference in diameters	+79 +28	+97 +31	+61 +10	+79 +13	+54 +3	+61 -5	+32 -19	+39 -27		
400 <D _s 500	-45 0	Housing tolerance	+20 +60	+20 +83	0 +40	0 +63	-7 +33	-20 +43	-32 +8	-45 +18		
		Mean	+57.5	+69	+37.5	+49	+30.5	+20	+5.5	+4		
		Probable difference in diameters	+84 +31	+105 +33	+64 +11	+85 +13	+57 +4	+7 -35	+32 -21	+40 -32		
500 <D _s 630	-50 0	Housing tolerance	+22 +66	+22 +92	0 +44	0 +70			-44 0	-70 0		
		Mean	+61.5	+74.5	+39.5	+52.5			-4.5	-17.5		
		Probable difference in diameters	+90 +33	+114 +35	+68 +11	+92 +13			+24 -33	+22 -57		
630 <D _s 800	-75 0	Housing tolerance	+24 +74	+24 +104	0 +50	0 +80			-50 0	-80 0		
		Mean	+66.5	+81.5	+42.5	+57.5			-7.5	-22.5		
		Probable difference in diameters	+97 +36	+125 +38	+73 +12	+101 +14			+23 -38	+21 -66		
800 <D _s 1000	-100 0	Housing tolerance	+26 +82	+26 +116	0 +56	0 +90			-56 0	-90 0		
		Mean	+71.5	+88.5	+45.5	+62.5			-10.5	-27.5		
		Probable difference in diameters	+105 +38	+137 +40	+79 +12	+111 +14			+23 -44	+21 -76		

1. A negative value denotes an interference fit and a positive value a loose fit
2. The probable fit values are calculated on the assumption that the statistical distribution of the dimensions within the tolerances follows a "normal" law (Gauss distribution law)
3. Bearing tolerances and fits: values in microns (µm)
4. ▼ The most common fits

■ Fits in the housings for normal class bearings (all bearings except tapered roller bearings)

HOUSING			▼									
Nominal diameter of housing (mm)	Tolerance on outside diameter (µm)	Fits	M6	M7	N6	N7	P6	P7	R6	R7		
10 <D _s 18	-8 0	Housing tolerance	-15 -4	-18 0	-20 -9	-23 -5	-26 -15	-29 -11	-31 -20	-34 -16		
		Mean	-5.5	-5	-10.5	-10	-16.5	-16	-21.5	-21		
		Probable difference in diameters	+1.5 -12.5	+5 -15	-3.5 -17.5	0 -20	-9.5 -23.5	-6 -26	-14.5 -28.5	-11 -31		
18 <D _s 30	-9 0	Housing tolerance	-17 -4	-21 0	-24 -11	-28 -7	-31 -18	-35 -14	-37 -24	-41 -20		
		Mean	-6	-6	-13	-13	-20	-20	-26	-26		
		Probable difference in diameters	+2 -14	+5.5 -17.5	-5 -21	-1.5 -24.5	-12 -28	-8.5 -31.5	-18 -34	-14.5 -37.5		
30 <D _s 50	-11 0	Housing tolerance	-20 -4	-25 0	-28 -12	-33 -8	-37 -21	-42 -17	-45 -29	-50 -25		
		Mean	-6.5	-7	-14.5	-15	-23.5	-24	-31.5	-32		
		Probable difference in diameters	+3 -16	+6.5 -20.5	-5 -24	-1.5 -28.5	-14 -33	-10.5 -37.5	-22 -41	-18.5 -52.5		
50 <D _s 65	-13 0	Housing tolerance	-24 -5	-30 0	-33 -14	-39 -9	-45 -26	-51 -21	-54 -35	-60 -30		
		Mean	-8	-8.5	-17	-17.5	-29	-29.5	-46	-46.5		
		Probable difference in diameters	+3.5 -19.5	+8 -25	-5.5 -28.5	-1 -34	-17.5 -40.5	-13.5 -46	-26.5 -49.5	-22 -55		
65 <D _s 80	-13 0	Housing tolerance	-24 -5	-30 0	-33 -14	-39 -9	-45 -26	-51 -21	-56 -37	-62 -32		
		Mean	-8	-8.5	-17	-17.5	-29	-29.5	-40	-40.5		
		Probable difference in diameters	+3.5 -19.5	+8 -25	-5.5 -28.5	-1 -34	-17.5 -40.5	-13.5 -46	-28.5 -51.5	-24 -57		
80 <D _s 100	-15 0	Housing tolerance	-28 -6	-35 0	-38 -16	-45 -10	-52 -30	-59 -24	-66 -44	-73 -38		
		Mean	-9.5	-10	-19.5	-20	-33.5	-34	-47.5	-48		
		Probable difference in diameters	+4 -23	+9 -29	-6 -33	-1 -39	-20 -47	-15.5 -53	-34 -61	-29 -67		
100 <D _s 120	-15 0	Housing tolerance	-28 -6	-35 0	-38 -16	-45 -10	-52 -30	-59 -24	-66 -47	-76 -41		
		Mean	-9.5	-10	-19.5	-20	-33.5	-34	-50.5	-51		
		Probable difference in diameters	+4 -23	+9 -29	-6 -33	-1 -39	-20 -47	-15.5 -53	-37 -64	-32 -70		
120 <D _s 140	-18 0	Housing tolerance	-33 -8	-40 0	-45 -20	-52 -12	-61 -36	-68 -28	-81 -56	-88 -48		
		Mean	-11.5	-11	-23.5	-23	-39.5	-39	-59.5	-59		
		Probable difference in diameters	+4 -27	+11 -33	-8 -39	-1 -45	-24 -55	-17 -61	-44 -75	-37 -81		
140 <D _s 150	-18 0	Housing tolerance	-33 -8	-40 0	-45 -20	-52 -12	-61 -36	-68 -28	-83 -58	-90 -50		
		Mean	-11.5	-11	-23.5	-23	-39.5	-39	-61.5	-61		
		Probable difference in diameters	+4 -27	+11 -33	-8 -39	-1 -45	-24 -55	-17 -61	-46 -77	-39 -83		
150 <D _s 160	-25 0	Housing tolerance	-33 -8	-40 0	-45 -20	-52 -12	-61 -36	-68 -28	-83 -58	-90 -50		
		Mean	-8	-7.5	-20	-19.5	-36	-36.5	-58	-57.5		
		Probable difference in diameters	+9.5 -25.5	+16 -31	-2.5 -37.5	+4 -43	-18.5 -53.5	-12 -59	-40.5 -75.5	-34 -81		
160 <D _s 180	-25 0	Housing tolerance	-33 -8	-40 0	-45 -20	-52 -12	-61 -36	-68 -28	-86 -61	-93 -53		
		Mean	-8	-7.5	-20	-19.5	-36	-36.5	-61	-60.5		
		Probable difference in diameters	+9.5 -25.5	+16 -31	-2.5 -37.5	+4 -43	-18.5 -53.5	-12 -59	-43.5 -78.5	-37 -84		
180 <D _s 200	-30 0	Housing tolerance	-37 -8	-46 0	-51 -22	-60 -14	-70 -41	-79 -33	-97 -68	-106 -60		
		Mean	-7.5	-8	-21.5	-22	-40.5	-41	-67.5	-68		
		Probable difference in diameters	+13.5 -28.5	+19.5 -35.5	-0.5 -42.5	+5.5 -49.5	-19.5 -61.5	-13.5 -68.5	-46.5 -88.5	-40.5 -95.5		
200 <D _s 225	-30 0	Housing tolerance	-37 -8	-46 0	-51 -22	-60 -14	-70 -41	-79 -33	-100 -71	-109 -63		
		Mean	-7.5	-8	-21.5	-22	-40.5	-41	-70.5	-71		
		Probable difference in diameters	+13.5 -28.5	+19.5 -35.5	-0.5 -42.5	+5.5 -49.5	-19.5 -61.5	-13.5 -68.5	-49.5 -91.5	-43.5 -98.5		
225 <D _s 250	-30 0	Housing tolerance	-37 -8	-46 0	-51 -22	-60 -14	-70 -41	-79 -33	-104 -75	-113 -67		
		Mean	-7.5	-8	-21.5	-22	-40.5	-41	-74.5	-75		
		Probable difference in diameters	+13.5 -28.5	+19.5 -35.5	-0.5 -42.5	+5.5 -49.5	-19.5 -61.5	-13.5 -68.5	-53.5 -95.5	-47.5 -102.5		
250 <D _s 280	-35 0	Housing tolerance	-41 -9	-52 0	-57 -25	-66 -14	-79 -47	-88 -36	-117 -85	-126 -74		
		Mean	-7.5	-8.5	-23.5	-22.5	-45.5	-44.5	-83.5	-82.5		
		Probable difference in diameters	+16 -31	+23 -40	0 -47	+9 -54	-22 -69	-13 -76	-60 -107	-51 -114		
280 <D _s 315	-35 0	Housing tolerance	-41 -9	-52 0	-57 -25	-66 -14	-79 -47	-88 -36	-121 -89	-130 -78		
		Mean	-7.5	-8.5	-23.5	-22.5	-45.5	-44.5	-84.5	-83.5		
		Probable difference in diameters	+16 -31	+23 -40	0 -47	+9 -54	-22 -69	-13 -76	-64 -111	-56.5 -118		
315 <D _s 400	-40 0	Housing tolerance	-46 -10	-57 0	-62 -26	-73 -16	-87 -51	-98 -41				
		Mean	-10.5	-11	-26.5	-27	-60	-59	-82			
		Probable difference in diameters	+15 -36	+22 -44	-1 -52	+6 -60	-26 -77	-19 -85				
400 <D _s 500	-45 0	Housing tolerance	-50 -10	-63 0	-67 -27	-80 -17	-95 -55	-108 -45				
		Mean	-12.5	-14	-29.5	-31	-67.5	-66	-95			
		Probable difference in diameters	+14 -39	+22 -50	-3 -56	+5 -67	-31 -84	-23 -95				
500 <D _s 630	-50 0	Housing tolerance	-70 -26	-86 -26	-88 -44	-114 -44	-122 -78	-148 -78				
		Mean	-30.5	-43.5	-48.5	-61.5	-82.5	-85.5				
		Probable difference in diameters	-2 -59	-4 -83	-20 -77	-22 -101	-54 -111	-56 -135				
630 <D _s 800	-75 0	Housing tolerance	-80 -30	-110 -30	-100 -50	-130 -50	-138 -88	-168 -88				
		Mean	-37.5	-52.5	-57.5	-72.5	-95.5	-110.5				
		Probable difference in diameters	-7 -68	-9 -96	-27 -88	-29 -116	-65 -126	-67 -154				
800 <D _s 1000	-100 0	Housing tolerance	-90 -34	-124 -34	-112 -56	-146 -56	-156 -100	-190 -100				
		Mean	-44.5	-61.5	-66.5	-83.5	-110.5	-127.5				
		Probable difference in diameters	-11 -78	-13 -110	-33 -100	-35 -132	-77 -144	-79 -176				

1. A negative value denotes an interference fit and a positive value a loose fit
2. The probable fit values are calculated on the assumption that the statistical distribution of the dimensions within the tolerances follows a "normal" law (Gauss distribution law)
3. Bearing tolerances and fits: values in microns (µm)
4. ▼ The most common fits

Bearing seats (continued)

Geometry and surface conditions of shaft and housing seats

■ Shoulder diameters and fillet radii

A contact surface is necessary between the ring and the shoulder to ensure good retention of the bearing.

► The sections in this catalog of Standard Bearings specifies:

- the shaft and housing shoulder diameters (D_1 and d_3)
- the shoulder fillet radii (r_1)

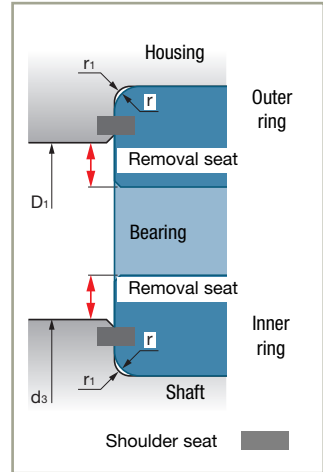

If for construction reasons the shoulder seat dimension cannot be respected, provide an extra spacer between the bearing ring and the shoulder.

The fillet radii between the shoulders and the ring seats must be less than the corner radius of the corresponding ring. The values are indicated in the chapter corresponding to each family.

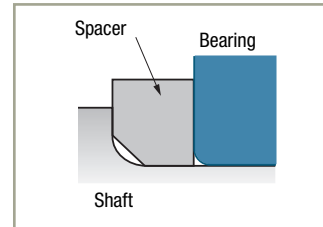

► Fillet greater than the bearing corner radius

When a shaft is subjected to high bending stresses, the shoulder must be given a fillet radius that is greater than that of the bearing.

In this case, a chamfered spacer is placed between the shaft shoulder and the bearing ring to give a sufficiently large contact surface.

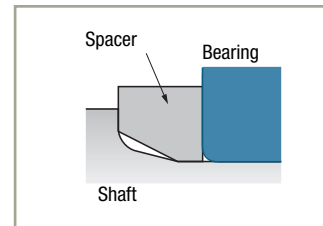

► Special corner radius

If the bearing must be fixed close to the shoulder, a special corner radius can be machined on its inner ring.

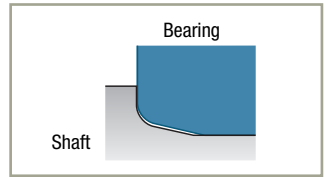

► Elimination of the fillet radius

If there are no particular requirements for the shaft profile and strength, it is possible to make an undercut that facilitates grinding of the seats and ensures in all cases the best contact between the ring and the shoulder.

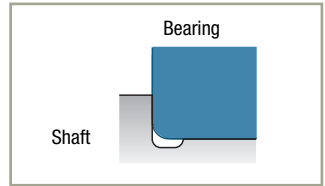

■ Removal seat

The bearing is usually removed using an extraction tool whose claws clamp on the part of the ring that protrudes beyond the shoulder. See page 140.

If the mounting configuration does not leave a sufficiently large removal seat, notches can be cut in the shoulder or a washer can be placed between the shoulder and the bearing inner ring.

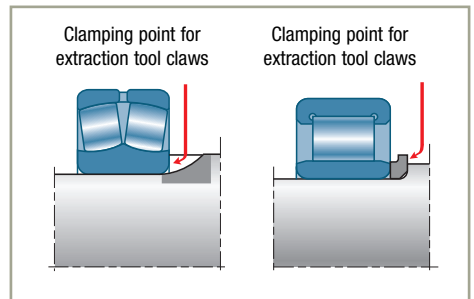

Bearing seats (continued)

Tolerances and surface conditions of shaft and housing seats

Shaft

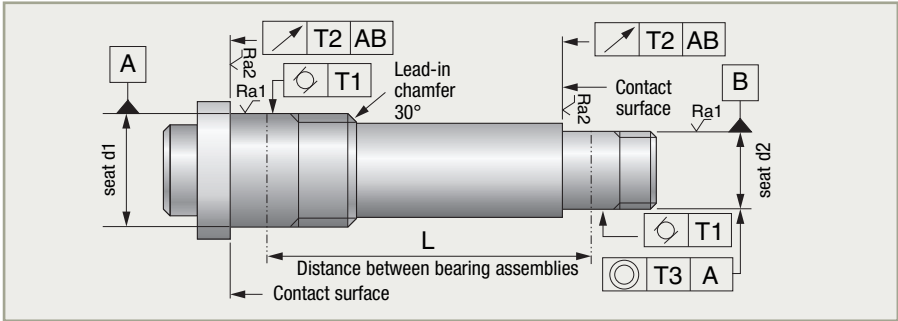

Nominal inside diameter of bearing d (mm)	Tolerances in μm				
	T1	T2	T3	Ra1	Ra2
10 $d \leq 18$	3	11	1.5 L L in mm	≤ 1	≤ 2
18 $d \leq 30$	4	13			
30 $d \leq 50$	4	16			
50 $d \leq 80$	5	19			
80 $d \leq 120$	6	22			
120 d	8	25			

Housing

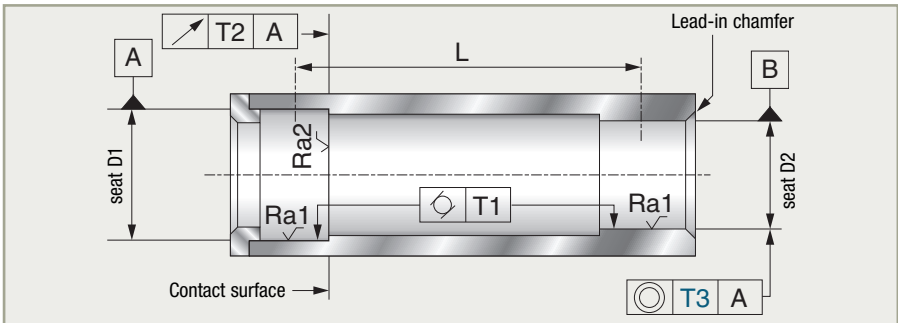

Nominal inside diameter of bearing d (mm)	Tolerances in μm				
	T1	T2	T3	Ra1	Ra2
18 $D \leq 30$	6	21	2 L L in mm	≤ 2	≤ 4
30 $D \leq 50$	7	25			
50 $D \leq 80$	8	30			
80 $D \leq 120$	10	35			
120 D	12	40			

Radial clearance of radial contact bearings

Residual radial clearance: definition, calculation

The residual radial clearance is the radial clearance of the bearing after installation or in operation. It depends on the internal radial clearance, the fits, the temperatures and the deformations.

The residual clearance must be sufficient to ensure satisfactory operating conditions.

To calculate the residual clearance, it is given an algebraic value. When this value is positive, there is a mechanical clearance, when it is negative there is a preload.

The operating residual clearance of the bearing has a direct influence on its service life and general performance (precision of rotation, noise, etc.). It must therefore be determined as accurately as possible.

→ Ratio of interference effect on clearance

When two parts are assembled together with an interference fit, each part displays a change in diameter after assembly.

The ratio is:

$$t_i \text{ or } t_e = \frac{\text{reduction of internal radial clearance}}{\text{interference on inner or outer ring}}$$

The ratio is calculated using the standard material strength formulae which introduce the cross-sectional dimensions of the parts concerned, the E modulus of elasticity and their respective Poisson ratios.

We propose the following approximate ratios for the most common cases:

Bearing element	Seat	Ratio
Inner ring	Solid shaft	$t_i \approx 0.8$
	Hollow shaft	$t_i \approx 0.6$
Outer ring	Steel or cast-iron housing	$t_e \approx 0.7$
	Light alloy housing	$t_e \approx 0.5$

SNR can provide a precise calculation of the clearance reduction.

Radial clearance of radial contact bearings *(continued)*

→ Residual clearance after fitting: J_{rm}

$$J_{rm} = J_o - t_i \cdot S_i - t_e \cdot S_e$$

J_o	Internal radial clearance
S_i	Interference of the inner ring on the shaft
t_i	Inner ring/shaft effect ratio
S_e	Interference of the outer ring in its housing
t_e	Outer ring/housing effect ratio

■ Required approximate mean residual clearance after fitting (in mm)

Ball bearings	$J_{rm} = 10^{-3} d^{1/2}$
Cylindrical roller bearings	$J_{rm} = 4 \cdot 10^{-3} d^{1/2}$
Self-aligning ball bearings	$J_{rm} = 2 \cdot 10^{-3} d^{1/2}$
Spherical roller bearings	$J_{rm} = 5 \cdot 10^{-3} d^{1/2}$

■ Example of calculation of residual clearance and its range using the fits tables of page 102.

Bearing 6305 - bore 25 mm - outside diameter 62 mm

- Solid steel shaft: tolerance k5
- Cast-iron housing: tolerance N6

■ Mean residual clearance

The fits tables give:

	min	mean	max
Shaft tolerances	+2		+11
Mean theoretical and probable value S_i		-11.5	
Probable clearance (+) or interference (-)	-5		-18

	min	mean	max
Housing tolerances	-33		+14
Mean theoretical and probable value S_i		-17	
Probable clearance (+) or interference (-)	-5.5		-28.5

Table in previous page gives the respective effect ratios of $t_i = 0.8$ (shaft) and $t_e = 0.7$ (housing).

The mean reduction in clearance is:

$$R_{jm} = (t_i \cdot S_i) + (t_e \cdot S_e)$$

(only valid if $S_i < 0$ and $S_e < 0$)

$$R_{jm} = (0.8 \times -11.5) + (0.7 \times -17) = -21 \mu\text{m}$$

■ The minimum initial clearance value must be greater than the mean reduction in clearance R_{jm}

The table in page 156 of initial clearances for this type of bearing shows that a category 4 clearance is necessary (23 to 41 μm : mean value 32 μm) to have a satisfactory residual clearance after fitting the bearing:

Mean residual clearance:

$$J_{rm} = 32 - 21 = 11 \mu\text{m}$$

The definition of the bearing will therefore be 6305 J40 (C4)

■ Range of residual clearance after fitting

Probable range of interference on the shaft
(difference between extreme values):

$$D_{pci} = 13 \mu\text{m}$$

Probable range of interference in the housing
(difference between extreme values):

$$D_{pli} = 23 \mu\text{m}$$

Considering the previous effect ratios, the probable ranges on radial clearance are:

$$\begin{aligned} D_{pce} &= D_{pci} \cdot t_i = 13 \mu\text{m} \times 0.8 \\ &= 10.5 \mu\text{m} \\ &\text{for the inner ring} \end{aligned}$$

$$\begin{aligned} D_{pce} &= D_{pli} \cdot t_e = 23 \mu\text{m} \times 0.7 \\ &= 16 \mu\text{m} \\ &\text{for the outer ring} \end{aligned}$$

Range of bearing internal clearance:

$$D_{er} = 41 - 23 = 18 \mu\text{m}$$

According to the laws of probabilities, the range of the residual clearance will be:

$$\begin{aligned} \Delta J_r &= (D_{pci}^2 + D_{pce}^2 + D_{er}^2)^{1/2} \\ &= (10.5^2 + 16^2 + 18^2)^{1/2} = 26 \mu\text{m} \end{aligned}$$

The 6305 bearing with a category 4 clearance mounted with k5 and N6 fits has an operating clearance of:

$$J_f = J_{rm} \pm D_{Jr}/2 = 11 \pm 13 \mu\text{m}$$

Radial clearance of radial contact bearings *(continued)*

→ Choice of internal clearance as a function of shaft and housing fits

The example on the previous page shows that interference fits on shaft and housing require a bearing with increased clearance.

The table below defines the limit fits for the shaft and housing.

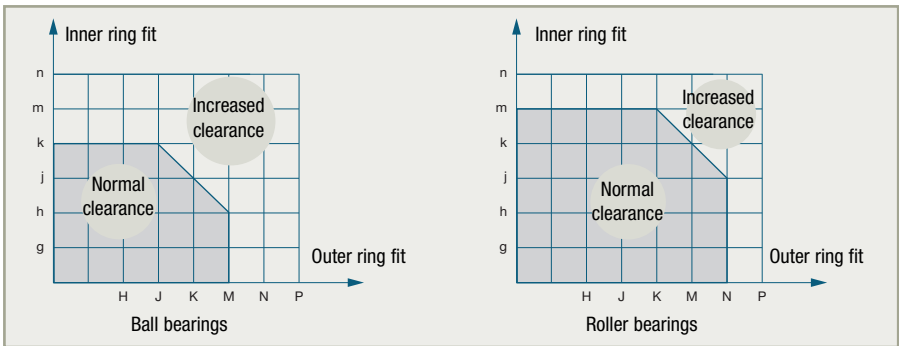

→ Calculation of the residual clearance in operation

The residual clearance in operation is a function of the residual clearance after mounting and the relative temperature differential between shaft and housing.

■ Materials with different coefficients of expansion

Bearing mounted in a light alloy housing.

The difference in the bearing and housing diameters resulting from differential expansion is:

$$\Delta D = (C_2 - C_1) D \cdot \Delta t = 8 \cdot 10^{-6} \cdot D \cdot \Delta t$$

where:

Δt Operating temperature 20°C (68°F)

D Bearing outside diameter

C1 Expansion coefficient of steel = 12×10^{-6} mm/mm/°C

C2 Expansion coefficient of the light alloy housing = 20×10^{-6} mm/mm/°C

The different expansion of the materials will increase the clearance of the outer ring in its housing and can allow it to rotate. This differential expansion must be compensated for by having a tighter fit and using a bearing with increased clearance.

► Example

Choice of housing fit for a 6305 bearing ($D = 62$ mm) mounted in light alloy with an operating temperature of 80°C (176°F).

$$\Delta t = 60^{\circ}\text{C}$$

$$\Delta D = 8 \cdot 10^{-6} \cdot 62 \cdot 60 = 0.030 \text{ mm}$$

With a J7 tolerance, the housing diameter is on average $10 \mu\text{m}$ larger than the bearing diameter.

$$\text{At } 80^{\circ}\text{C, it is } 10 \mu\text{m} + \Delta D = 40 \mu\text{m}$$

See page 101.

This value is too high to secure a good retention of the bearing in the housing. Therefore, choosing a P7 housing tolerance with a mean interference of $30 \mu\text{m}$ will compensate for the effect of differential expansion at 80°C (176°F).

Choosing a P7 tolerance for the outer ring will lead to a reduction in the radial clearance of the bearing equal to:

$$t_e \cdot S_e = 0,5 \cdot 29,5 = 15 \mu\text{m}$$

If the shaft with a k6 tolerance gives a mean interference of $13,5 \mu\text{m}$ on the inner ring, the reduction of the radial clearance due to the inner ring fit is:

$$t_i \cdot S_i = 0,8 \cdot 13,5 = 11 \mu\text{m}$$

The total reduction in the bearing clearance due to fitting is:

$$R_{jm} = t_e \cdot S_e + t_i \cdot S_i = 15 + 11 = 26 \mu\text{m}$$

One therefore chooses a 6305J40/C4 bearing (clearance category 4: mean radial clearance of $32 \mu\text{m}$) to avoid cancelling the clearance during operation at 20°C (68°F) normal temperature.

Radial clearance of radial contact bearings *(continued)*

■ Temperature difference between shaft and housing

Both the shaft and housing are made of steel, but the temperature of the shaft is higher than that of the housing.

The differential expansion between the bearing inner ring and the outer ring will reduce the radial clearance by the value

$$\Delta J = C1 \times (D \cdot \Delta tl - d \cdot \Delta ta)$$

where:

- C1 Expansion coefficient of the steel
- D Bearing outside diameter
- d Bearing bore
- Δta Difference between the running temperature of the shaft and the room temperature (specified at 20°C or 68°F)
- Δtl Difference between the running temperature of the housing and the room temperature (specified at 20°C or 68°F)

► Example

Let us assume that a 6305 bearing (25 x 62) has a residual clearance J_{rm} of 10 μm after fitting at 20°C (68°F).

In operation:

- the temperature of the shaft and the inner ring is 70°C (158°F)
- the temperature of the housing and the outer ring is 50°C (122°F)

The reduction in radial clearance of the bearing is:

$$\Delta J = 12 \cdot 10^{-6} \cdot ((62 \cdot 30) - (25 \cdot 50)) = 7 \mu\text{m}$$

The operating residual radial clearance is:

$$J_{rf} = J_{rm} - \Delta J = 10 \mu\text{m} - 7 \mu\text{m} = 3 \mu\text{m}$$

In this case it is recommended to use a bearing from Group 3 increased clearance.

Axial clearance of angular contact bearings

Axial preload

A preload is a permanent axial force applied to the bearings when they are fitted. It is obtained by the penetration of the inner ring with respect to the outer ring of each bearing from the reference position.

→ Axial penetration and preload

Under load, the rolling element / raceway contact points undergo plastic deformation due to the very high Hertz pressures, giving an axial displacement of one ring in respect to the other. A curve gives the value of the relative displacement of the two rings according to the axial load.

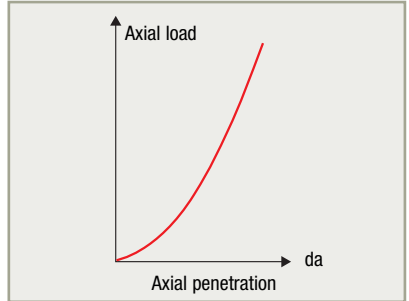

In an assembly with two bearings mounted in opposition, the penetration of one bearing increases the clearance of the other.

In assemblies demanding very high guidance precision (machine-tool spindle, bevel gears, oscillating systems, etc.), a preload must be applied to get rid of the clearance and give optimum rigidity.

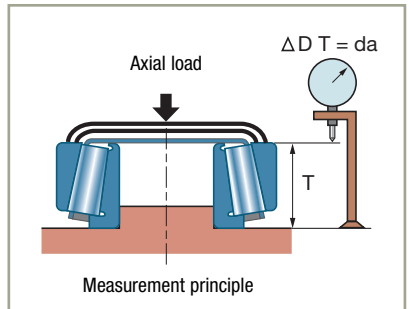

Axial clearance of angular contact bearings *(continued)*

→ Determining the preload

The preload value P is chosen as a function of the mean axial load applied (A_m)

$$P = A_m / 3$$

The two preloaded bearings are studied using the diagram of associated penetration curves.

Without an external axial load, the meeting point (P) corresponds to the applied preload that creates on each bearing a penetration of (d_1) and (d_2) respectively, the total closing of the two bearings being $p = d_1 + d_2$

When an external axial load A is applied to the assembly, each bearing follows its penetration curve. One of the two bearings is subject to an additional penetration (d_a) which reduces the penetration of the opposite bearing by as much

To find the loads F_{a1} and F_{a2} applied to each bearing, the axial load A is positioned between the two curves (points M_1 and M_2).

The axial equilibrium of the shaft is:

$$F_{a1} - F_{a2} = A$$

If A exceeds the value F_d (unseating axial load), the opposite bearing gets an operating axial clearance.

► Remarks:

The diagram of associated penetration curves is modified by any radial loads applied to the bearings.

As any preload influences the resultant loads applied to the bearings, bearing performances must be calculated taking into account the preload value. Consult SNR for these calculations that bring into play the rigidity characteristics. A preloaded assembly has greater friction drag torque than an assembly with clearance. Its lubrication must therefore be studied with the utmost care.

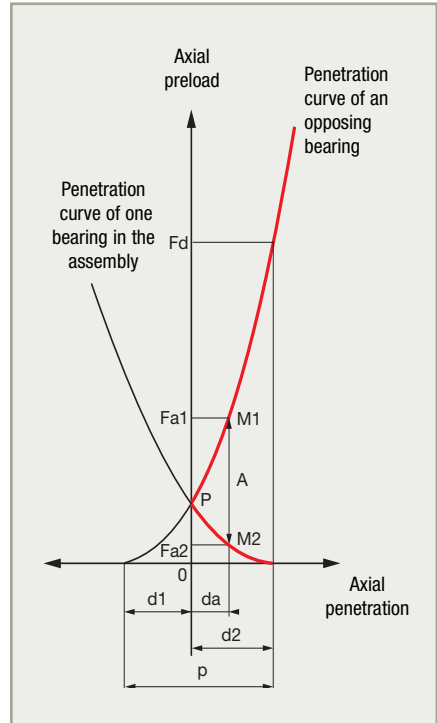

→ Adjustment

The adjustment enables an assembly to be given the predetermined axial clearance or preload. This is done by sliding one ring (inner or outer) of one of the two bearings of the assembly. This ring must therefore be loose fitted on its seat.

If the assembly is to have an axial clearance j_a , it is checked using a dial comparator.

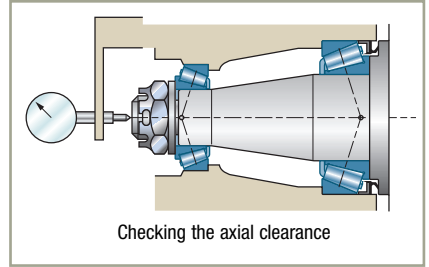

If the assembly is to have a preload value p , one starts with any axial clearance J_a and then the loose bearing ring is moved by the value $J_a + p$. This operation is usually achieved with the shaft nut or by adapting the thickness of the adjustment spacers in the housing. The allowed tolerance on a preloaded setting is tight (about half the one permitted for the axial clearance).

Influence of the temperature on the axial clearance of bearings

→ Modification of clearance on assembly

The axial clearance or preload of a shaft mounted on two angular-contact bearings (ball or tapered roller bearings) can be changed by the operating temperatures.

The assembly opposite schematically illustrates:

- a change in the axial clearance of the assembly due to the difference of axial expansion between the housing and the shaft
- a modification in the outer ring / housing interference that results in a variation of the radial clearance and therefore the axial clearance of the assembly

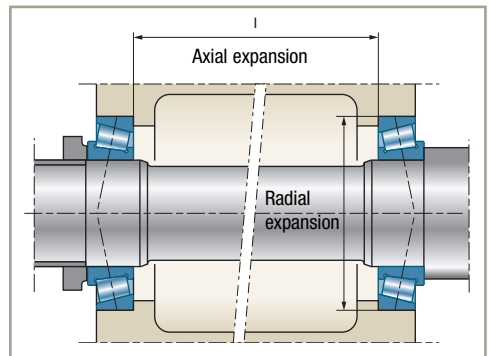

The total change of the axial clearance of the assembly is the algebraic sum of these two variations.

In an O assembly (case shown in the sketch), the two variations are in opposite directions and may cancel each other out. Conversely, in an X assembly the two variations are in the same direction.

Axial clearance of angular contact bearings (continued)

→ Theoretical calculation of the variation in the axial clearance of an assembly

■ Variation due to shaft and housing different axial expansion

$$\Delta Ja_1 = (l \cdot C_2 \cdot \Delta t) - (l \cdot C_1 \cdot \Delta t) = (C_2 - C_1) \cdot l \cdot \Delta t$$

where:

- l** Distance between the bearings
- C1** Expansion coefficient of the shaft
- C2** Expansion coefficient of the housing
- Δt** Difference between the operating temperature and the room temperature (specified at 20°C or 68°F)

■ Variation due to the modification of the outer ring/housing interference

	Bearing 1	Bearing 2
Temperature at which the outer ring/housing interference is cancelled by the expansion of the housing	$\Delta t_{01} = S_1 / ((C_2 - C_1) \cdot D_1)$	$\Delta t_{02} = S_2 / ((C_2 - C_1) \cdot D_2)$
	D_1, D_2 S_1, S_2	Outside diameters of the bearings Diametral interference of the bearings
Variations of interference with temperature	If $\Delta t \leq \Delta t_{01}$: $\Delta S_1 = (C_2 - C_1) \cdot D_1 \cdot \Delta t$ If $\Delta t > \Delta t_{01}$: $\Delta S_1 = S_1$	If $\Delta t \leq \Delta t_{02}$: $\Delta S_2 = (C_2 - C_1) \cdot D_2 \cdot \Delta t$ If $\Delta t > \Delta t_{02}$: $\Delta S_2 = S_2$
Variation of axial clearance due to the modification of the outer ring/housing interference	$\Delta Ja_2 = (K_1 \cdot te_1 \cdot \Delta S_1) + (K_2 \cdot te_2 \cdot \Delta S_2)$ te_1, te_2 : effect ratio of this interference on the radial clearance page 109 K_1, K_2 : transformation coefficients of radial clearance into axial clearance $K_1 = Y_1 / 0.8$ Y_1, Y_2 see page 59 $K_2 = Y_2 / 0.8$	

■ Total variation in the axial clearance of the assembly

Assembly in X arrangement

$$\Delta Ja = \Delta Ja_2 + \Delta Ja_1$$

Assembly in O arrangement

$$\Delta Ja = \Delta Ja_2 - \Delta Ja_1$$

These calculations enable the initial clearance to be fixed in order to get the desired clearance values in operation.

■ Example

Take an assembly of two 32 210 tapered roller bearings mounted in an O arrangement in an aluminium housing (P7 fit); operating temperature 80°C (176°F):

- $l = 240 \text{ mm}$
- $D_1 = D_2 = 90 \text{ mm}$
- $C_2 - C_1 = 8 \times 10^{-6} \text{ mm/mm}^\circ\text{C}$
- $Y_1 = Y_2 = 1.43$
- $S_1 = S_2 = 0.0335 \text{ mean value}$
- $\Delta t = 60^\circ\text{C} (140^\circ\text{F})$
- $te_1 = te_2 = 0.5 \text{ see page 109}$

► Variation in axial clearance due to axial expansion ΔJa_1 $\Delta Ja_1 = 8 \cdot 10^{-6} \cdot 240 \cdot 60 = 0.114 \text{ mm}$

► Variation due to the modification in the outer ring/housing interference

	Bearing 1	Bearing 2
Temperature at which the outer ring/housing interference is cancelled by the expansion of the housing	$\Delta t_0 = \Delta t_2 = 0.0335 / (8 \cdot 10^{-6} \cdot 90) = 47^\circ\text{C}$	
Variations of interference with temperature	$\Delta t > \Delta t_0$ and Δt_2 $\Delta S_1 = \Delta S_2 = 0.0335$	
Variation of axial clearance due to the modification in outer ring/housing interference	$\Delta Ja_2 = ((1.43 / 0.8) \cdot 0.5 \cdot 0.0335) + (1.78 \cdot 0.5 \cdot 0.0335) = 0.060$	

► Total variation in the axial clearance of the assembly $\Delta Ja = + 0.060 - 0.114 = -0.054$

The following graphs illustrate the variation in axial clearance of the assembly according to the operating temperature in the X and O assembly arrangements.

Assembly in O arrangement

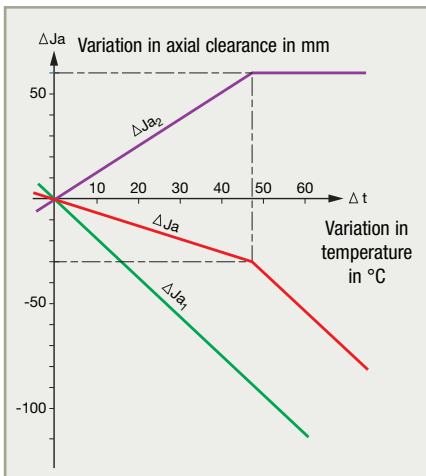

Assembly in X arrangement

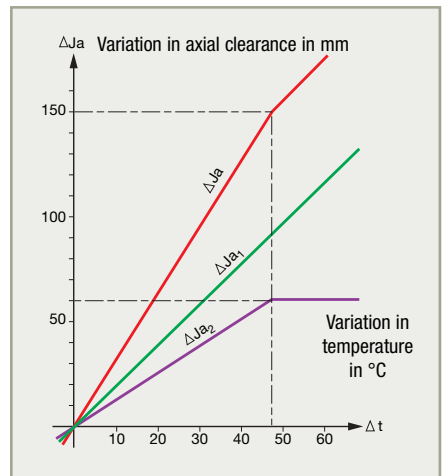

Lubrication

■ General principals of lubrication	122
<i>Choosing the type of lubrication</i>	122
Grease lubrication	123
■ Characteristics of greases	123
■ Greasing recommendations	124
■ Choice of grease according to the application	125
■ Quantity	128
Oil lubrication	131
■ Lubrication systems	132
■ Quantity of oil	134

General principals of lubrication

Lubrication is essential for optimum bearing performance.

70% of bearing failures are due to lubrication problems.

The aim of lubrication is to provide a film of lubricant (oil film) between the rolling elements and the raceway of the bearing in order to prevent wear and seizure of the components in contact.

The lubricant also provides protection against oxidation and external contamination, and can have a cooling effect in the case of recirculating oil.

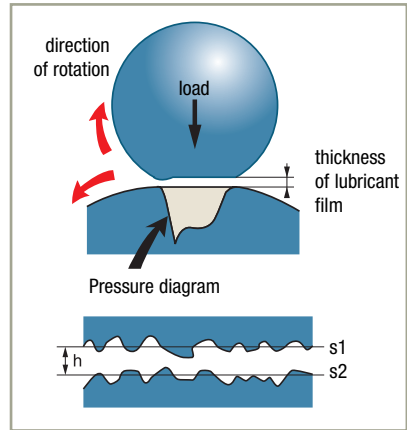

The service life of the bearing is directly related to the efficiency of the lubricant film, which depends on:

- the nature of the lubricant and its speed and temperature capabilities...
- the load and speed of rotation of the bearing

The influence of lubrication on the bearing life can be determined page 77.

→ Choosing the type of lubrication

	Oil lubrication	Grease lubrication
Advantages	<ul style="list-style-type: none"> ▶ Good penetration in the bearing ▶ Good physical and chemical stability ▶ Cooling possibility ▶ Easy monitoring of the lubricant: condition and levels 	<ul style="list-style-type: none"> ▶ Cleanliness of the mechanism ▶ Sealing easier to secure ▶ Protection barrier ▶ Assembly simplicity ▶ Ease of manipulation ▶ Reduction or elimination of relubrication ▶ Possibility of using pre-greased bearings
Disadvantages	<ul style="list-style-type: none"> ▶ Necessary to effectively seal the assembly ▶ Poor protection against oxidation and moisture in case of long stops ▶ Starting delay when circulation of oil is necessary prior to rotation 	<ul style="list-style-type: none"> ▶ Higher friction coefficient than for oil ▶ Poorer dissipation of heat ▶ Replacement (if necessary) requires dismounting and washing of the bearing ▶ No possibility of checking the level of grease, therefore it requires reliable grease retention or periodic addition to compensate for leaks, contamination or ageing

Grease lubrication

Characteristics of greases

■ Grease is a product whose consistency ranges from semi-fluid to solid and which is obtained by dispersing a thickening agent (soap) in a liquid lubricant (mineral or synthetic oil). Additives can be included to bring certain specific properties.

The increasing use of grease-lubricated bearings combined with the development of the life-lubrication concept, has made grease an integral component of the bearing. The service life of the bearing and its behaviour in diverse environments are largely determined by the properties of the grease.

■ Physical and chemical characteristics:

Consistency

▶ NLGI (National Lubrication Grease Institute) grades correspond to a value of penetration in the kneaded grease (per test specification ASTM/D217).

▶ The consistency generally chosen for bearings is grade 2.

NLGI grades	Kneaded penetration	Consistency
0 1	385 - 355 340 - 310	Semi-fluid Very soft
2 3	295 - 265 250 - 220	Soft Moderate
4	205 - 175	Semi-hard

Viscosity of the basic oil: usually defined in cSt (mm²/s) at 40°C (104°F).

Density: 0.9 approx.

Drop point: temperature at which the first drop of a grease falls from a sample.

Approximate temperature: 180°C (356°F) to 260°C (500°F) depending on the constituents of the grease. The maximum service temperature of the grease is always far below the drop point.

■ Functional characteristics

The conditions under which the lubricant works (rolling, kneading) require special bearing greases that cannot be selected only on the basis of the physical and chemical characteristics.

The SNR Research and Test Centre constantly performs qualification tests on bearings that enables us to give advice on the recommended grease for the application.

The qualification specification concerns the following basic criteria:

- endurance in ball bearings
- endurance in roller bearings
- water resistance
- high and low temperature resistance
- adherence when exposed to centrifugal forces
- vibration resistance (false Brinell effect)
- high speed adequacy, etc.

➔ These criteria may be met in order to satisfy the customer's goal. The selection for an application is a compromise between the required specifications and the available greases.

Grease lubrication *(continued)*

Greasing recommendations

Sealed and shielded bearings are fitted with grease before packing. With the other bearings, the grease must be added with great care in order not to reduce bearing performance.

■ Method to apply the grease

Cleanliness is essential

Any foreign body in the grease can cause the premature destruction of the bearing.

- Thoroughly clean the area around the bearing
- Protect the grease containers against contamination
- The use of a grease gun provides a guarantee of cleanliness

The grease must be applied as close as possible to the active parts of the bearing (raceways and rolling elements)

Insert the grease between the cage and the raceway of the inner ring, especially where angular-contact or spherical or self-aligning bearings are concerned.

For each assembly, record the date of past and future lubrications, and the type and weight of grease

- ▶ Assemblies and bearings with lubrication devices
 - Clean the lubricator head
 - Get rid of all foreign particles
 - Check and clean the spout of the grease gun
 - Introduce the grease
 - Pay particular attention to the quantity introduced
 - Remove the old grease at every 4th or 5th relubrication
 - When relubrication is very frequent, provide a system for removing the old grease

- ▶ Assemblies and bearings without a greasing device
 - Carefully clean the assembly before opening it
 - Remove the old grease with a non-metallic spatula
 - Introduce the grease between the rolling elements on both sides
 - Grease the shields and seals

■ Greasing devices

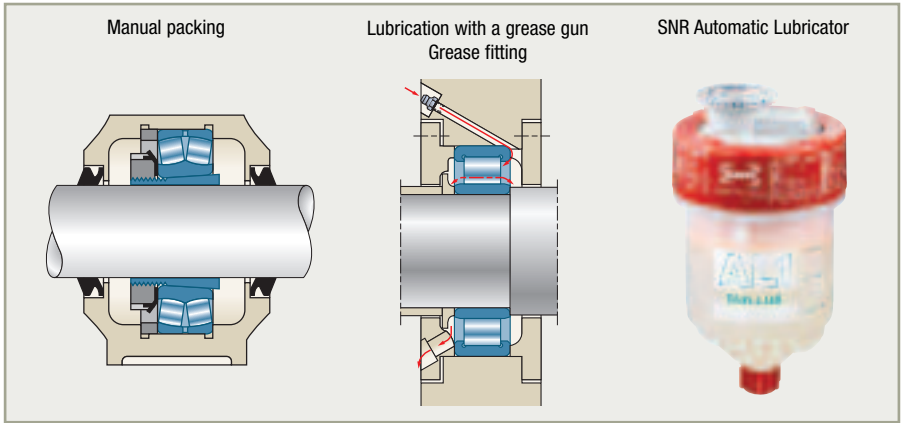

Choice of grease according to the application

■ The choice of grease is based on the knowledge of the operating conditions, which must be carefully considered: temperature, rotation speed, load, environment, vibration, application-specific constraints.

Ask your SNR ROULEMENTS contact for assistance in choosing the grease for your application. The table on the following page will help to make an initial choice.

■ There are two types of operation

Normal operating conditions

SNR recommends two types of greases:

- ▶ SNR LUB MS: for assemblies on machines, agricultural machinery, electric motors, handling equipment, pumps
- ▶ SNR LUB EP: for heavily-loaded bearings (iron and steel industry, civil engineering)

Special operating conditions

The application specifications will be studied in close cooperation with SNR ROULEMENTS in the following cases:

- Continuous operating temperature above +100°C (212°F) or below -30°C (-22°F)
- Speed greater than 80% of the bearing maximum speed
- Moist environment
- Centrifugal forces (outer ring rotating) or vibration
- Low torque
- Presence of hydrocarbons
- Nuclear radiation, etc.

The viscosity of the base oil is of great importance for lubrication efficiency. The diagram on page 78 can be used to check lubrication efficiency for your application.

The majority of general-purpose greases can be mixed with one another. However, to obtain the best result avoid mixing greases (the mixing of certain special application greases is forbidden).

SNR can supply sealed and shielded bearing pre-greased with a type of grease that is appropriate for the application (see technical range bearings or check minimum order quantity).



Choice of grease according to the application

Predominant operating conditions	Service limits		General recommendation	Examples of applications	SNR LUB recommendation
	Temp. °C (°F)	Speed			
Standard use	-30 (-22) up to +110 (+248)	< max. speed of bearing	<ul style="list-style-type: none"> ▶ Mineral oil ▶ Traditional soap (lithium, calcium...) ▶ Consistency: usually grade 2, grade 3 for large bearings or bearings with particular operating characteristics ▶ Drop in performance above 80°C (+176°F) in continuous operation, certain applications can require a better suited grease 	<ul style="list-style-type: none"> ▶ Automobiles ▶ Agricultural machinery ▶ Common mechanisms ▶ Handling equipment ▶ Electric tools 	LUB MS
High load	-30 (-22) up to +110 (+230)	< 2/3 max. speed of bearing	<ul style="list-style-type: none"> ▶ Similar to standard greases with extreme pressure additive 	<ul style="list-style-type: none"> ▶ Iron and steel industry ▶ Civil engineering equipment 	LUB EP
High temperature	-30 (-22) up to +130 (+266)	< 2/3 max. speed of bearing	<ul style="list-style-type: none"> ▶ Traditional soap with high-viscosity mineral-base or synthetic oil 	<ul style="list-style-type: none"> ▶ Class-E electric motors ▶ Class-F electric motors ▶ Alternators 	LUB HT
	-20 (-4) up to +150 (+302)				
	-20 (-4) up to +200 (+428)	≤ 1/3 max. speed of bearing	<ul style="list-style-type: none"> ▶ Entirely synthetic greases ▶ Greases with silicone-base oil have reduced resistance to loads 	<ul style="list-style-type: none"> ▶ Furnace equipment ▶ Class-H electric motors ▶ Couplers 	LUB THT
	-20 (-4) to +250 (+482)	< 1/5 max. speed of bearing	<ul style="list-style-type: none"> ▶ Synthetic products in solid or paste form ▶ Poorly miscible products 	<ul style="list-style-type: none"> ▶ Furnace equipment ▶ Kiln cars 	Consult SNR
Low temperature	up to -50 (-58)	≤ 2/3 max. speed of bearing	<ul style="list-style-type: none"> ▶ Basic oil of very low viscosity ▶ Marginal retention of grease if temperature above 80°C (+176°F) 	<ul style="list-style-type: none"> ▶ Aviation ▶ Special machines 	LUB GV*
High speed	-20 (-4) up to +120 (+248)	≤ 4/3 max. speed of bearing	<ul style="list-style-type: none"> ▶ Oil of very low viscosity 	<ul style="list-style-type: none"> ▶ Machine-tool spindles ▶ Wood-working machines ▶ Textile spindles 	
Moisture	-30 (-22) up to +120 (+248)	≤ 2/3 max. speed of bearing	<ul style="list-style-type: none"> ▶ Conventional grease heavily treated with anti-corrosion additives 	<ul style="list-style-type: none"> ▶ Washing machines 	LUB MS LUB EP
Centrifugal forces/ Vibration/ Outer ring rotating	-20 (-4) up to +130 (+266)	≤ 2/3 v2/3 max. speed of bearing	<ul style="list-style-type: none"> ▶ Grease with strong adherence consistency (grade 2) 	<ul style="list-style-type: none"> ▶ Alternators ▶ Civil engineering equipment ▶ Loose pulleys 	LUB VX
Food industry	-30 (-22) up to +120 (+248)	≤ 2/3 max. speed of bearing	<ul style="list-style-type: none"> ▶ Compatible with food processing applications 	<ul style="list-style-type: none"> ▶ Food-processing industry 	LUB AL1
High load and low speed	-5(+23) up to +140 (+284)		<ul style="list-style-type: none"> ▶ Suitable for very low speed operation under very high loads 	<ul style="list-style-type: none"> ▶ Heavy industry : Steel industry, paper mill Industry, Quarries 	LUB FV

Note : The grease must be chosen in collaboration with SNR.



Characteristics of the SNR LUB product range

Colour	MS	EP	HT	GV*	VX	THT	AL1	FV	
	Amber	Amber	Light brown	Light yellow	Blonde	White	Transparent yellowish		
Composition	<ul style="list-style-type: none"> ▸ Mineral oil ▸ Lithium soap 	<ul style="list-style-type: none"> ▸ Mineral oil ▸ Extreme pressure ▸ Lithium soap 	<ul style="list-style-type: none"> ▸ Synthetic oil ▸ Barium soap 	<ul style="list-style-type: none"> ▸ Di-ester oil ▸ Lithium soap 	<ul style="list-style-type: none"> ▸ Mineral paraffinic oil ▸ Lithium soap 	<ul style="list-style-type: none"> ▸ Thickening perfluorin fluid ▸ Teflon 	<ul style="list-style-type: none"> ▸ Mineral paraffinic oil ▸ Complex aluminium soap 	<ul style="list-style-type: none"> ▸ Mineral oil ▸ Lithium + calcium 	
Viscosity of base oil	105	105	150	15	310	390	200	950	
Consistance Grade NLGI	2	2	2	2	2	2	2	2	
Service temperature °C (°F)	-30 (-22), +120 (+248)	-30 (-22), +110 (+230)	-30 (-22), +150 (+302)	-50 (-58), +120 (+248)	-20 (-4), +130 (+266)	-20 +220	-20 +250*	-30 (-22), +120 (+248)	-5 (-23) +140 (+284)
Moderate loads P < C / 5	G	VG	G	G	G	VG	G	G	
High load P > C / 5	NR	VG	NR	NR	VG	VG NR	G	VG	
Low speed N.Dm < 100000	G	G	NR	NR	VG	VG	G	VG	
High speed N.Dm > 100000	G	G	G	VG	NR	G G	G	NR	
Moisture, Presence of water	VG	VG	G	VG	G	G	G	G	
Low amplitude oscillations	G	G	VG	G	VG	VG	G	G	
Vibration when stationary	NR	NR	NR	VG	NR	NR	NR	NR	
Adherence	G	G	VG	G	VG	VG	G	VG	
Low torque	G	G	G	VG	NR	NR	G	NR	
Low Noise	G	G	G	VG	NR	NR	NR	NR	
Anti-corrosion protection	VG	VG	G	VG	G	G	G	G	
Resistance to chemical agents	NR	NR	NR	NR	NR	VG	NR	NR	
Pump wise	VG	VG	VG	VG	VG	VG	VG	G	
Remarks			<ul style="list-style-type: none"> ▸ Service life of grease is linked with working temperature 	<ul style="list-style-type: none"> ▸ Pay special attention to: - quantity - shaft position - close active parts - grease retention 			<ul style="list-style-type: none"> ▸ Approved by US Food and Drug Administration - as H1 class 		

N.Dm : Product of the RPM times the mean diameter
VG : Very good performance – **G** : Good performance
NR : Not recommended

* Under low load, the THT grease sustains up to +250°C (+482)
 Under higher load, thermal strength is limited to +220°C (+428)

Grease lubrication *(continued)*

Quantity

■ Initial greasing

The quantity of grease necessary for optimum operation of a bearing must be equal to 20 to 30% of its free internal volume.

Approximate amount of grease
to be introduced into an open bearing

$$G = 0.005 D \cdot B$$

G: Quantity of grease in g or cm³

D: Outside diameter of bearing in mm

B: Bearing width in mm.

The quantity of grease may be increased by 20% for assemblies provided with a hole for drainage of the old grease.

A bearing that rotates at very low speed can be fully packed with grease, which favours its protection in highly contaminated environments (conveyor rollers, etc.)

It is very important that this quantity should be maintained inside the bearing. Check that the adjacent parts (seals, shields) are capable of limiting the transfer of grease. If there is an adjacent free space, fill it to 50% with grease.

One can verify that the quantity of grease is adequate if the bearing temperature stays at a level of 10°C (50°F) to 30°C (86°F) above the room temperature, after a transient state of less than one hour during which the temperature has peaked at a higher level.

■ Relubrication

Relubrication frequency

The following table can be used to establish the basic frequency in hours according to the type of bearing and speed of rotation.

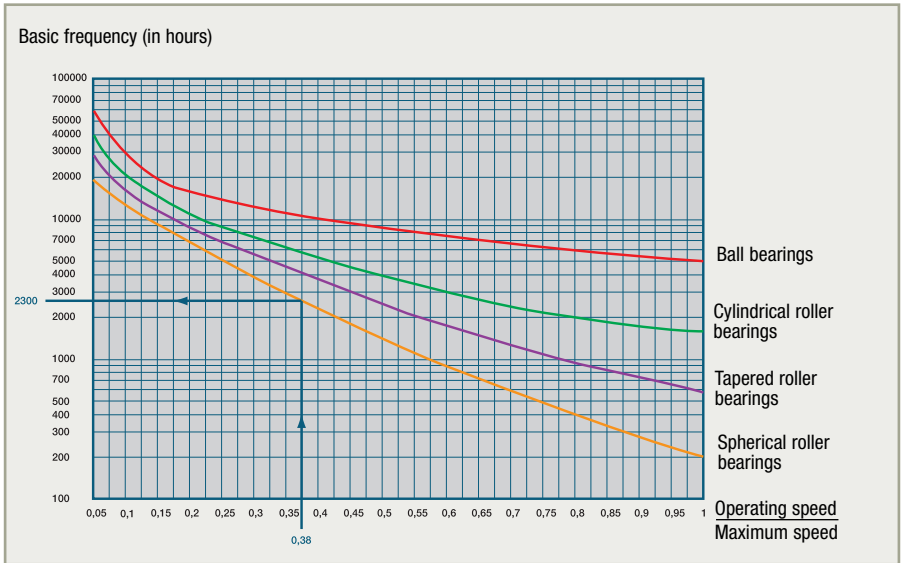

■ Correction of relubrication frequency

The **basic frequency (F_b)** must be corrected using factors taken from the table below, according to the particular operating conditions of the mechanism, using the relation:

$$F_c = F_b \cdot T_e \cdot T_a \cdot T_t$$

Factor	Conditions	Level	Value of factor	
T_e	Environment - dust - humidity - condensation	- moderate	0.8	
		- high	0.5	
		- very high	0.3	
T_a	Application - with impacts - with vibration - with vertical shaft	- moderate	0.8	
		- high	0.5	
		- very high	0.3	
T_t	Temperatures	75°C	0.8 0.5 0.3	With standard grease
		75° à 85°C 85° à 120°C 120° à 170°C		

Grease lubrication (continued)

■ Weight of grease

The opposite table can be used to determine the factor **c** to be applied, depending on the corrected frequency in hours to obtain the weight of grease to be added from the relation.

$$P = D \times B \times c$$

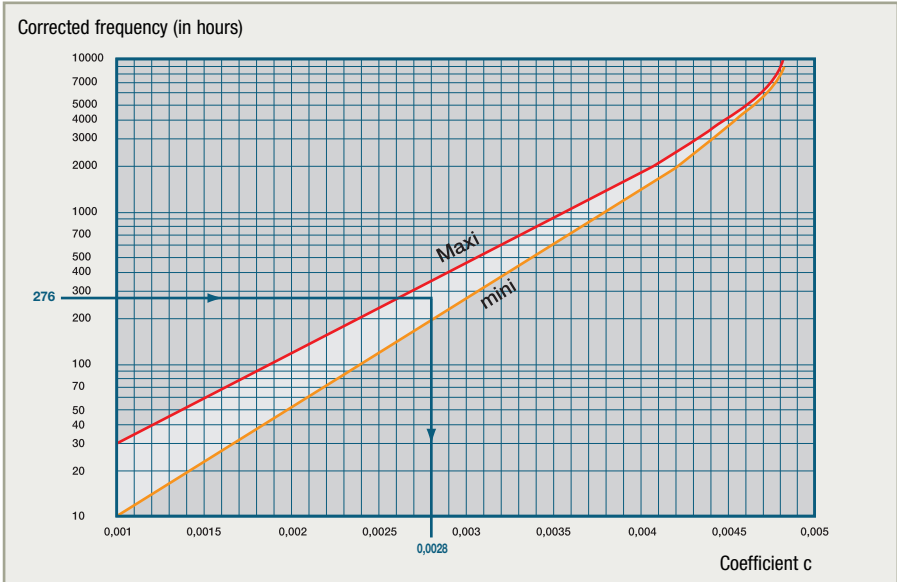

Example

A 22212 EA bearing lubricated with a standard grease and rotating at 1,500 RPM in a dusty environment at 90°C (194°F) with no other application constraints:

22212 – Spherical roller bearing

Service speed/Maximum speed = 1,500 rpm / 3,900 rpm = 0.38

hence the basic frequency: $F_b = 2,300$ hours (see table of the preceding page)

Coefficients

$T_e = \longrightarrow 0.5$ dust
 $T_a = \longrightarrow 0.8$ normal
 $T_t = \longrightarrow 0.3$ 90°C (194°F)

$c = 0,028$

Diameter $D = 110$

Width $B = 28$

Weight of grease:

$P = 110 \cdot 28 \cdot 0.0028 = 9$ grams



Corrected frequency: $F_c = F_b \cdot T_e \cdot T_a \cdot T_t = 2,300 \cdot 0.5 \cdot 0.8 \cdot 0.3 = 276$ hours

Oil lubrication

Oil lubrication is generally used when the bearing is adapted in a mechanism that is already lubricated (gear reducer, gearbox) or else when it can benefit from a central lubrication system where the oil is also used as a coolant.

■ Type of oil

Principal oil types used to lubricate bearings.

		Mineral oils	Synthetic oils	
			ester	perfluoroalkylether
Comments		Standard use	Special use, usually at high or low temperature	
Density		0,9	0,9	1,9
Viscosity	Index	80 - 100	130 - 180	60 - 130
	Variation with temperature	high	low	low
Freezing point		-40 up to -15°C (-40 up to 5°F)	-70 up to -30°C (-94 up to -22 °F)	-70 up to -30°C (-94 up to -22 °F)
Flash point		< 240° C (464°F)	200 up to 240°C (392 up to 464°F)	non inflammable
Resistance to oxidation		average	good	excellent
Thermal stability		average	good	excellent
Compatibility with elastomers		good	to be checked	good
Price level		1	3 - 10	500

■ Viscosity

The choice of the oil viscosity is very important for the efficiency of lubrication. The choice can be made using the diagram in page 78.

It can be seen from this diagram that life duration increases with the viscosity of the lubricant. This advantage is nevertheless limited because a more viscous lubricant raises the operating temperature of the bearing.

■ Additives

The most commonly used additives are the Extreme Pressure, anti-wear and anti-corrosion additives. Great care must be used in choosing an additive. One must check with the lubricant manufacturer to check the influence of the additive on the bearing performance.

Extreme pressure

- Protects metal surfaces against micro-welding
- Necessary when the bearing is highly loaded

Oil lubrication *(continued)*

Anti-wear

Reduces the wear of the metal surfaces by forming a protective surface layer

Anti-corrosion

Protects metal surfaces against corrosive attacks

■ Contamination

The lubrication oil must be clean.

■ Special lubricants

In certain assemblies the bearing can be lubricated by the liquid carried in the assembly (hydraulic fluid, diesel fuel).

In such cases, and for all the lubrication problems mentioned here, check with SNR.

Lubrication systems

■ Oil bath

Used in closed and sealed mechanisms.

Oil level at the level of the lowest rolling element of the lowest bearing.

Moderate rotation speed as heat dissipation is limited.

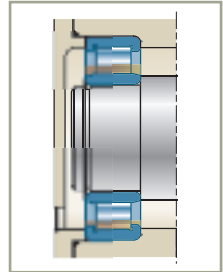

■ One time usage oil

Shaft rotating at high speed.

Necessary evacuation of the old oil.

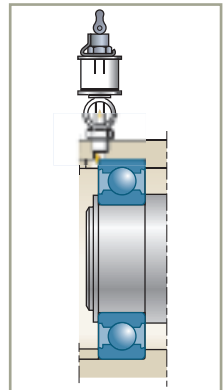

■ Dripping and splashing

Oil usually thrown up by the gears.

The oil can be directed to the bearing by channels.

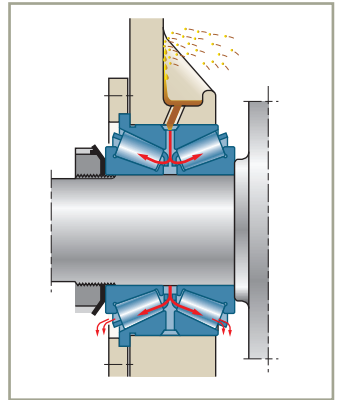

■ Oil circulation

A pump ensures a constant flow, a reserve compensates for the priming delay starting.

The oil can be filtered and cooled in a heat exchanger to give better performance.

Oil circulation can sometimes be intermittent.

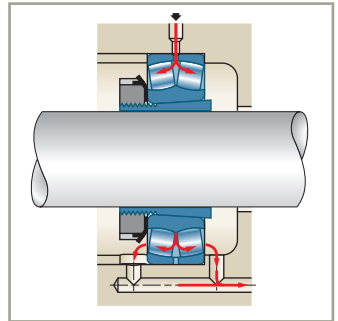

■ Oil spray

This is also a low-consumption method of one time usage lubrication. The oil under pressure spray reaches all parts of the bearing, prevents the entry of foreign bodies and acts as a coolant.

Used for high precision bearings rotating at very high speed.

Consult the SNR catalogue of high precision bearings for machine-tool spindles.

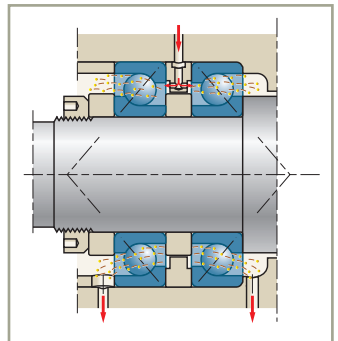

Important: Most oil lubrication systems do not secure an adequate film during the first few rotations of the bearing. It is therefore strongly recommended to oil new bearings after installation.

Oil lubrication *(continued)*

Quantity of oil

The diagram below gives an idea of the minimum safe flow rate under normal service conditions for bearings.



Fitting-removal and maintenance

Fitting of bearings	136
■ General rules	136
■ Fitting principles	136
■ Hot fitting	137
■ Press fitting (or with anti-rebound hammer)	138
■ Adapter sleeves	139
Removal of bearings	140
■ Removal with extractors or press	140
■ Removal of tapered bore bearings	141
Maintenance	141
■ Monitoring and preventive maintenance	141
■ Causes of premature bearing failure	142
<i>Examination of failed bearings</i>	142
<i>Appearance of failures</i>	142
<i>Causes of bearing failure</i>	145
■ Storage	146
<i>Packaging</i>	146
<i>Storage conditions</i>	146

Fitting of bearings

General rules

■ Cleanliness

Cleanliness must be the constant concern of the installer. Any contamination from foreign matter will result in rapid deterioration of the bearing.

Protect the bearing against contamination if it has to be stored in the workshop before fitting.

■ Fitting precautions for sealing components

Lubricate the seal seats while fitting. A bead of grease applied at the seal lip and on the shaft passage helps to increase the efficiency of the seal and limit risks of damage.

Fitting principles

- Check the bearing reference and review the drawings, specifications and procedures
- Check that the dimensions and the precision of the shapes and positions of the bearing seats are in accordance with the SNR drawings and specifications
- Prepare all equipment, parts and the necessary tools before starting the fitting procedure. Ensure that all these elements are clean
- Carefully clean and check all parts and components that are adjacent to the bearing
- Remove the bearing from its packing at the last moment, working on a perfectly clean workbench
- Never wash the new bearing, unless it is exceptionally specified

The bearing is protected against oxidation by a thin film of oil compatible with all lubricants

- Fit the bearing using the selected method
- Lubricate with a special bearing grease in accordance with the instructions
- After fitting and before start of operation, check operating conditions to avoid possible defects (noise, vibration, temperature, abnormal clearance, etc.)

■ Pressurized casings

In certain applications there is a pressure difference between the casing and the outside environment that demands certain fitting precautions. Bearings with standard integrated sealing do not allow a pressure difference between the two sides of the bearing due to the risk of eliminating the lubricant and turning back the seal lips.

Only seals independent from the bearing seals can support a pressure difference. These are essentially metalloplastic seals and mechanical seals. When the pressure difference is significant, special seals adapted to the environment shall be used.

Certain mechanisms are placed under slight positive pressure to prevent contamination of the internal components. In this case the protection system shall be of the non-friction type in order to ease venting.

Hot fitting



Important: Heating with a flame is absolutely prohibited

- Hot fitting involves expanding the bearing to allow an effort-free installation on its shaft. The temperature must not be too high to prevent alteration of the characteristics of the steel (maximum 130°C or 266°F) or internal components of the bearing. It must however be sufficiently high to give an adequate expansion allowing easy installation of the bearing by temporary cancellation of the interference fit.
- The heating temperature depends primarily on the bearing dimension and secondly on the fit category and the seat material.

As a general rule, the following temperature values can be applied:	Bore diameter	Heating temperature
	up to 100 mm	+ 90°C (194°F)
	from 100 to 150 mm	+120°C (248°F)
	over 150 mm	+130°C (266°F)

- The various heating methods used to fit a bearing onto its shaft are:

Induction heating with SNR appliances

Heating by induction is the most clever and safe method of raising the bearing temperature:

▶ Installer safety

Only the part to be heated undergoes a rise in temperature, which eases handling and reduces the risk of burns.

▶ Temperature control

The temperature is controlled by an integrated probe. The initial qualities of the bearing are thus totally protected.

▶ Demagnetization

The electronics of the appliance undergoes automatically a demagnetization step at the end of the cycle.



Fitting of bearings (continued)

■ Oil bath

The oil and the container must be clean.

The oil must be fluid (e.g. F oil).

Locally higher temperatures occurring in the bath may damage the bearing; place an insulating spacer between the bearing and the bottom of the container.

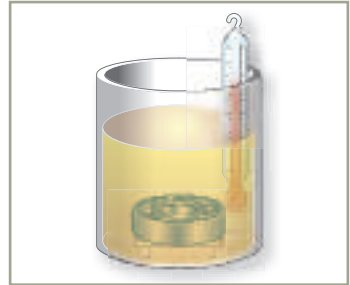

■ Hot plate

Avoid direct contact of the bearing with the plate by means of a supporting block. It is compulsory to use a supporting block with sealed bearings.

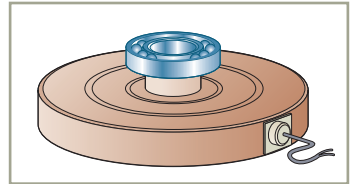

■ Freezing

Cooling of the shaft

Cold fitting may sometimes be possible by shrinking the shaft in a bath of liquid nitrogen at -170°C (-274°F).

Press fitting (or with anti-rebound hammer)

Apply the force on the ring to be installed. This force must not under any circumstances be transmitted through the rolling elements, as this would make dents in the raceways.

Use a tube or socket to apply the pressure on the ring that has to be tight fitted.

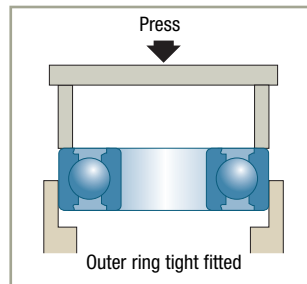
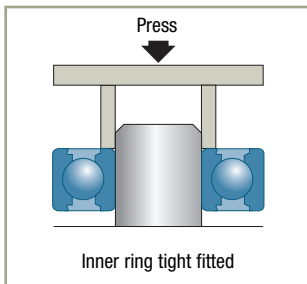

► If there is a tight fit on the shaft and on the housing, use a socket that applies pressure on the two rings simultaneously.

The two contact surfaces are in the same plane to ensure correct installation of the bearing.

► This method is particularly recommended for fitting self-aligning ball bearings or spherical roller bearings.

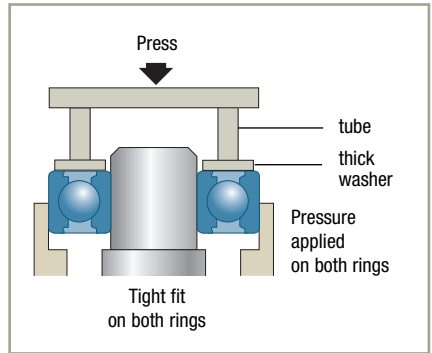

Adapter sleeves

■ Two main types of sleeves

Adapter sleeve, the most common

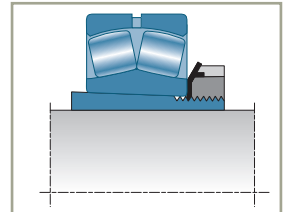

Withdrawal sleeve which makes the removal of large bearings easier

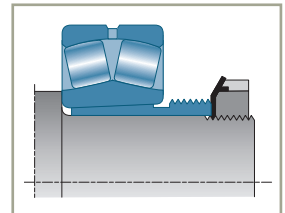

■ **Fitting self-aligning ball bearings or spherical roller bearings**

Ball bearings

While tightening the nut, check for:

- smoothness of rotation
- easy swivelling of the outer ring over the balls

Tightening is continued very gradually until one starts to feel resistance to swivelling the bearing, at this point rotation must still be easy.

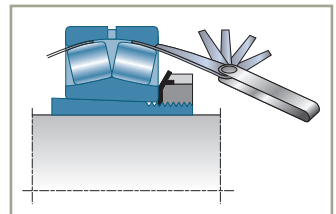

Roller bearings

The SNR clearance card gives the required clearance and the procedure for checking using feeler gauges.

Removal of bearings

Removal with extractors or press

■ Apply the force on the ring to be removed. The force must not under any circumstances be transmitted through the rolling elements.

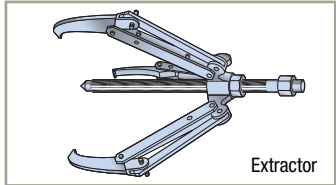

■ Bearings tight fitted on the shaft

If you expect to reuse the bearing grip it by its inner ring to avoid transmitting the extraction force through the rolling elements.

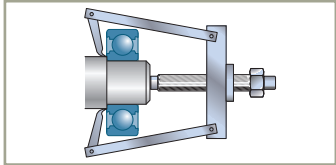

If no extractor is available, use a vice, resting the inner ring on a stand above the jaws and with the shaft hanging freely between them. The extraction force is applied either with a mallet or with a press.

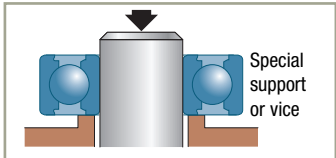

If the bearing abuts against a shoulder that is higher than the thickness of the ring, it can be dislodged using the knife extractor tool shown in the opposite figure. This tool may be used as a support for the extractor.

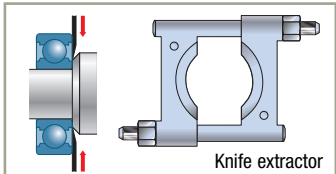

■ Bearings tight fitted in the housing

Apply the removal force on one of the faces of the outer ring through a tube as is shown in the opposite figure.

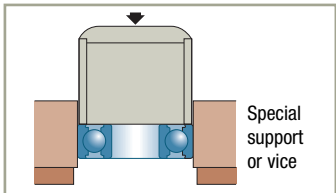

■ Bearings interference-fitted on the shaft and in the housing

The principle consists in letting the shaft follow the bearing when it is extracted from the housing.

The force must be exerted on the outer ring and not on the shaft.

The opposite figure illustrates this process which assumes that the housing is accessible from both sides. The bearing is then separated from the shaft.

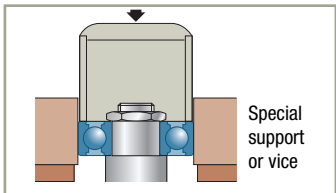

Removal of tapered bore bearings

With bearings fitted on an adapter sleeve, unscrew the nut and then extract the bearing by its inner ring.

Bearings fitted on a withdrawal sleeve are removed by means of a withdrawal nut.

Large bearings are sometimes fitted directly on a tapered-seat shaft (e.g. rolling mill pillow block). In such cases, they are removed using oil pressure.

Holes made for this purpose permit connection of a high pressure pump which forces oil between the shaft seat and the inner ring. The elastic expansion of the inner ring enables the bearing to be removed.

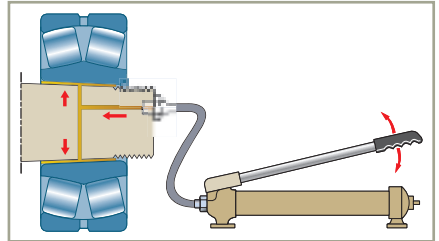
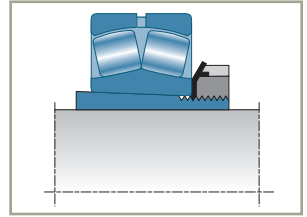

Maintenance

Monitoring and preventive maintenance

Broadly speaking the bearing does not require any monitoring or maintenance in operation other than the addition of lubricant if applicable. In certain applications it is very important to avoid bearing failures for either safety reasons (aeronautics, mine ventilation, etc.) or economic reasons (damage to machines, production shut down). In such cases monitoring and preventive maintenance are necessary.

The beginning of bearing deterioration can be diagnosed by witnessing an increase in the level of vibration, noise, temperature, rotation torque. The most common means of checking is the vibration level. Detection can be in a summary way by listening (transmission through stethoscope or metal rod) or by electronic devices (frequency and amplitude analysers) which give the alert or stop the machine.

The efficiency of these checks depends on the qualification and experience of the operator and the quality of the equipment used. In the case of grease lubricated bearings, monitoring the thermal level is also a good indicator of the working conditions.

The inspection frequency depends on the reliability goals, the equipment usage ratio and the company internal organisation. The frequency must be based on the likely service life of the bearing.

Maintenance *(continued)*

Causes of premature bearing failure

→ Examination of failed bearings

The examination of a failed bearing is a valuable source of information to identify its installation and operating conditions, therefore it must be carried out methodically and with precision:

■ Before removal

- note noises
- vibrations
- rise in temperature
- loss of lubricant
- contamination

■ During removal

- remove the end caps, seals (do not wash them), and grease, then place them in a clean place for later examination
- record the torque of the tightening nut that clamps the ring faces
- note the axial and radial positions of the bearing (identification marks on rings with respect to the shaft and the housing) and the direction of installation
- check the fits in at least 2 planes (shaft and housing)
- note the condition of the seats and the surrounding parts

■ After removal

- perform visual examination
- dismantle the bearing
- examine the components
- analyse the grease, check for foreign particles by washing and filtering

→ Appearance of failures

■ Fatigue spalling

Cracking and removal of material fragments.



■ Surface spalling

Stains resulting from flaking of surface material.



■ Seizing

Matte areas with removal of material, brown marks from heating, deformation of rolling elements, local melting and scoring of the metal.



■ Indentations caused by deformation

Ball or roller indentations corresponding to the space between the elements. The bottom of each indentation is shiny, but the original grinding marks are still visible. The material has been displaced without wear.

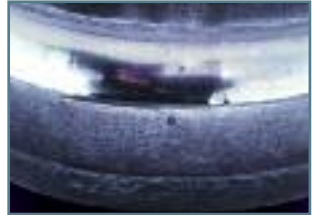

■ Raceway indentations due to abrasive wear

Indentations which may or may not correspond to the spacing of the rolling elements. Removal of material due to the vibration to which the bearing is subjected when stationary.

■ Wear

General wear of the rolling elements, raceways and cage. Grey tint (due to the effect of abrasive contamination).



■ Pitting and fluting

Pits with sharp edges or sequence of narrow parallel grooves resulting from the leakage of an electric current.



Maintenance *(continued)*

■ Nicks, cracks, fractures

Impact load dents, removal of surface material, cracks, fracture of rings



■ Fretting corrosion

Red or black discoloration of the bearing contact surfaces, on the face, in the bore or on the outside diameter.



■ Corrosion

Local or total oxidation of the bearing surfaces, both inside and outside.



■ Discoloration

Discoloration of the raceways and rolling elements: over heating of protection oil.

■ Cage failure

Bending, wear, fractures.



→ Causes of bearing failure

The causes of failure can be related to four main sources:

■ Poor fitting procedure

- Inadequate or improper fitting equipment and method
- Contamination during fitting
- Excessive force
- Poor construction of bearing seats: shafts and housings out of tolerances, poor lubricant access, misalignment

■ Operating conditions

- Overloads, accidental or otherwise
- Vibration in service or when stationary
- Excessive speed
- Shaft bending

■ Environmental conditions

- Ambient temperature too low or too high
- Conduction current across the bearing
- Contamination by water, dust, chemical products, textile debris, etc...

■ **Lubrication** (deterioration can result from one or more causes. The following table summarizes the types of deterioration and enables the user to identify the probable origin)

- Incorrect choice of lubricant
- Unsuitable quality
- Inadequate relubrication frequency

The SNR technical file "Causes of premature bearing failure" describes and illustrates in detail the identification, diagnostics and prevention of the various types of failure. For a more detailed examination, consult SNR.

ORIGIN	Fatigue SPALLING	Superficial SPALLING	SEIZING	RACEWAY INDENTATIONS due to loss of shape or detachment of metal	RACEWAY INDENTATIONS due to abrasion	WEAR AND INDENTATIONS due to abrasion	PITTING AND FLUTING	SHOCK MARKS - CRACKS	METAL-TO-METAL CONTACT CORROSION	CORROSION	CAGE FAILURE
FITTING											
Lack of care											
Shocks											
Housing or seat defects											
Fit too tight											
Fit too loose											
Misalignment											
OPERATION											
Overload											
Vibration											
Excessive speed											
ENVIRONMENT											
Too low temperature											
Electric current leakage											
Water contamination											
Dust contamination											
LUBRICATION											
Inadequate lubrication											
Lack of lubricant											
Excessive lubricant											

Maintenance *(continued)*

Storage

Bearings must be stored in a clean and dry place. Certain rules must be observed to maintain the original quality of the bearing.

→ **Packaging**

■ **The bearing is protected and packed by SNR under carefully controlled conditions:**

- Assembly in an air-conditioned dust-free environment.
- A rust-inhibiting protective grease with high covering power is applied in a controlled environment. It is compatible with all standard lubricants.
- A greaseproof wrapping further improve the rust protection.
- The cardboard box completes the protection.

Bearings must be stored in their original packaging, which should not be opened until just before installation.

→ **Storage conditions**

■ Premises

The following are the normal storage conditions: general cleanliness, a dust-free and non-corrosive atmosphere, recommended temperature: 18 to 20°C (64,4 to 68°F), maximum relative humidity: 65%. In exceptional climatic conditions special packaging will be required (tropical packaging).

Avoid using wooden shelves. Store at a distance of at least 30 cm (1 foot) from the floor, walls and heating pipes. Avoid exposure to direct sunlight. Store the boxes flat. Do not stack them too high. Arrange boxes so that the bearing. Part number can be read without having to move the boxes.

■ Storage life

The standard SNR packaging guarantees long-term storage under normal indoor storage conditions. For it is a must not to open, not to change and not to damage the packaging.

The shelf life counts from the date indicated on the packaging.

Special-purpose packaging intended for products shipped to OEMs is only suitable for a rapid usage of the products. Such packaging will not provide the same long storage life.

Appendices and terminology

Appendices	148
■ Bearing standards	148
■ Gear teeth forces	149
Terminology	151
■ Vocabulary	151

Appendices

Bearing standards

Characteristics		Standards
► Terminology		ISO 5593
► Dimensions	Ball and roller bearings (except tapered roller and thrust bearings)	ISO 15
	Tapered roller bearings	ISO 355
	Self-aligning unit bearings	ISO 2264
	Thrust bearings	ISO 104
	Snap ring grooves	ISO 464
	Snap rings	ISO 464
	Eccentric locking collars	ISO 3145
	Tapered sleeves	ISO 113/1
	Nuts and lock-washers	ISO 2982
	Split pillow blocks	ISO 113/2
Self-aligning bearing units	ISO 3228	
	Corner radii	ISO 582
► Precision	Definitions	ISO 1132
	All types of bearings	ISO 492
	Thrust bearings	ISO 199
► Clearances	Radial internal clearance	ISO 5753
► Basic dynamic load and bearing life		ISO 281/1
► Basic static load (or basic static capacity)		ISO 76
► Thermal reference speed		ISO 15312

Gear tooth forces

T Tangential force
 C Transmitted torque
 Dp Tooth pitch diameter

$$T = 2C / Dp$$

S Separation forces
 A Axial forces

■ Straight-tooth cylindrical gear

α = pressure angle

$$S = T \tan \alpha$$

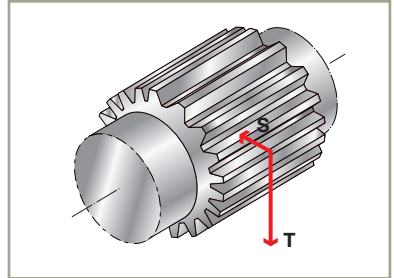

■ Helical-tooth cylindrical gear

α = pressure angle

$$S = T \tan \alpha / \cos \gamma$$

γ = helix angle

$$A = T \tan \gamma$$

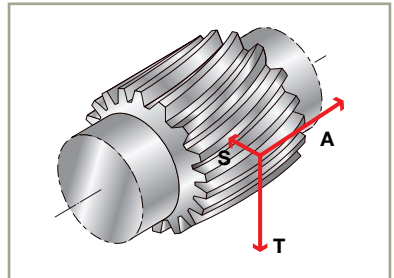

■ Straight-tooth bevel gear

$$T = T_p = T_c$$

α = pressure angle

$$S_p = -A_c = T \tan \alpha \cos \theta$$

θ = 1/2 angle at gear apex

$$A_p = -S_c = T \tan \alpha \sin \theta$$

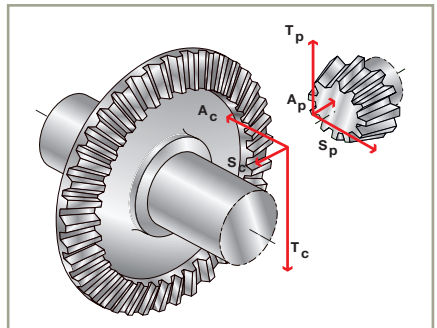

Appendices (continued)

■ Helical-tooth bevel gear

- D_p = pitch diameter of the driving gear
- D_c = pitch diameter of the driven gear
- L = tooth length
- D_p = mean diameter of the driving gear
- D_c = mean diameter of the driven gear
- T_p = tangential force of the driving gear
- T_c = tangential force of the driven gear

$$T_c = T_p = 2 C / D_p$$

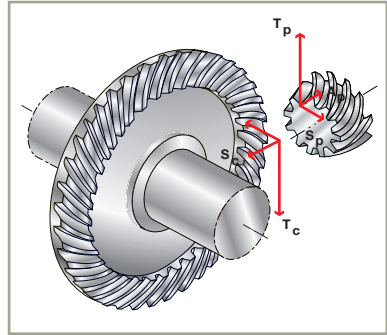

- α = pressure angle
- γ_p = helix angle of driving gear
- γ_c = helix angle of the driven gear
- ($\gamma_p = \gamma_c$ for straight-tooth and helical-tooth bevel gear pairs)

- β_p = 1/2 angle at apex of driving gear
- β_c = 1/2 angle at apex of driven gear

- Direction of gear rotation:**
 (for an observer standing on the large base of the cone and looking at the apex)
- + counter-clockwise
 - clockwise

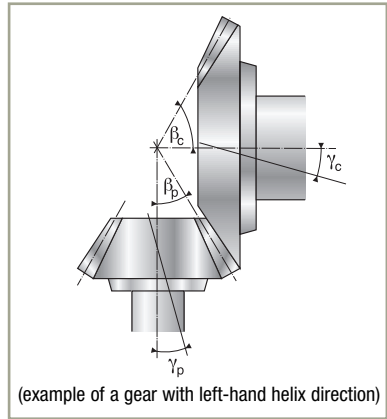

Direction of the helix	Direction of gear rotation	Separation force	Axial force
right or left	-	Driving gear (moving away from driven gear) $S_p = \frac{T_p}{\cos \gamma_p} \cdot (\text{tg} \alpha \cos \beta_p + \sin \gamma_p \sin \beta_p)$	Driving gear (moving away from driven gear) $A_p = \frac{T_p}{\cos \gamma_p} \cdot (\text{tg} \alpha \sin \beta_p - \sin \gamma_p \cos \beta_p)$
	+	Driven gear (approaching driving gear) $S_c = \frac{T_c}{\cos \gamma_c} \cdot (\text{tg} \alpha \cos \beta_c - \sin \gamma_c \sin \beta_c)$	Driven gear (approaching driving gear) $A_c = \frac{T_c}{\cos \gamma_c} \cdot (\text{tg} \alpha \sin \beta_c + \sin \gamma_c \cos \beta_c)$
right or left	+	Driving gear (moving away from driven gear) $S_p = \frac{T_p}{\cos \gamma_p} \cdot (\text{tg} \alpha \cos \beta_p - \sin \gamma_p \sin \beta_p)$	Driving gear (moving away from driven gear) $A_p = \frac{T_p}{\cos \gamma_p} \cdot (\text{tg} \alpha \sin \beta_p + \sin \gamma_p \cos \beta_p)$
	-	Driven gear (approaching driving gear) $S_c = \frac{T_c}{\cos \gamma_c} \cdot (\text{tg} \alpha \cos \beta_c + \sin \gamma_c \sin \beta_c)$	Driven gear (approaching driving gear) $A_c = \frac{T_c}{\cos \gamma_c} \cdot (\text{tg} \alpha \sin \beta_c - \sin \gamma_c \cos \beta_c)$

Terminology

Vocabulary

Symbol	Description	Unit
α	nominal angle of contact	°
B	width of bearing inner ring	mm
C	width of bearing outer ring	mm
C	basic dynamic capacity of a bearing	N
C_0	basic static capacity of a bearing	N
C_e	equivalent basic dynamic capacity of an assembly	N
C_{0e}	equivalent basic static capacity of an assembly	N
D	outside diameter of the bearing	mm
D_w	mean diameter of the rolling element	mm
d	bearing bore diameter	mm
fc	factor for calculating the basic dynamic load	
f_s	safety factor	
F_a	total axial load on the bearing	N
F_r	total radial load on the bearing	N
J_a	theoretical axial clearance	mm
J_r	operating radial clearance	mm
i	number of rows of rolling elements	
l	effective length of the contact generating surface	mm
L_{10}	nominal service life	
N	speed of rotation	tr/mn
P	equivalent dynamic radial load of the bearing	N
P_0	equivalent static radial load of the bearing	N
T	nominal width of a tapered bearing	mm
X	radial factor of bearing	
X_0	static radial factor	
Y	axial factor of bearing	
Y_0	static axial factor	
Z	number of rolling elements	



Single-row radial ball bearings

Single-row radial ball bearings	154
■ Definitions and capabilities	154
■ Series	154
■ Variations	155
■ Tolerances and clearances	155
■ Design criteria	157
■ Suffixes and prefixes	157
■ Characteristics	158
<i>Open bearing</i>	158
<i>Sealed and shielded bearing</i>	170
<i>Bearing with groove</i>	180
Stainless steel radial ball bearings	184
■ Definitions and capabilities	184
■ Series	184
■ Variations	185
■ Suffixes	185
■ Characteristics	186
<i>Stainless steel radial ball bearings</i>	186
Bearings for special applications	188
■ Definitions and capabilities	188
■ Series	188
■ Variations	189
■ Tolerances and clearances	189
■ Characteristics	190
<i>Bearings for special applications TOPLINE</i>	190
<i>Bearings for high temperatures or for kiln cars</i>	196
Bearing-inserts	198
■ Bearing-inserts of self-aligning bearings units	198
<i>Definition and capabilities</i>	198
<i>Series</i>	198
■ Bearing-insert with cylindrical outside diameter	200
<i>Series</i>	200
■ Tolerances and clearances	201
■ Suffixes and prefixes	201
■ Characteristics	202
<i>Bearing-insert for self-aligning bearings units (mm)</i>	202
<i>Bearing-insert for self-aligning bearings units (inch)</i>	212
<i>Bearing-insert with cylindrical outside diameter (mm)</i>	224
<i>Bearing-insert with cylindrical outside diameter (inch)</i>	226

Single-row radial ball bearings

Definition and capabilities

The single-row radial ball bearing is the most widely used type of bearings.

→ Definition

■ Cages for single-row ball bearings

The standard cage is in pressed steel or brass. Other cage types can be used: synthetic material, phenolic resin, machined brass.

→ Capabilities

■ Loads and speeds

Designed to:

- withstand radial loads
- withstand axial loads in both directions
- accept high speeds of rotation

■ Misalignment

These bearings accept misalignment of between 0.10° and 0.23° depending on the residual clearance of the bearing after fitting, the bearing series and the magnitude of loads. Where misalignment is high, it is recommended to use a bearing with a synthetic material cage, as these cages display greater flexibility and good wear resistance.

Series

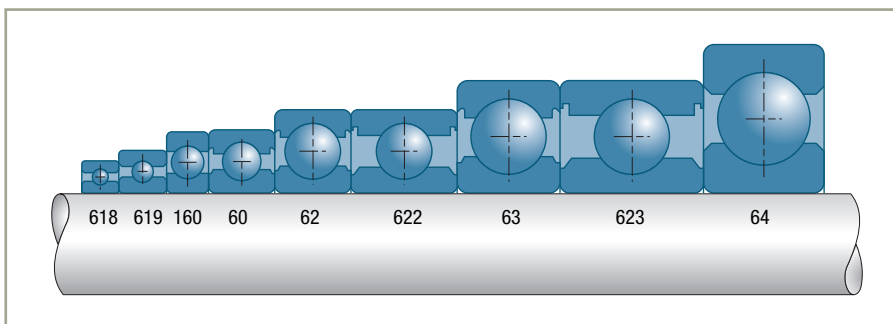



Variations

■ Standard protection and sealing

These bearings can be equipped with:

- shields (suffix ZZ)
- seals (suffix EE)

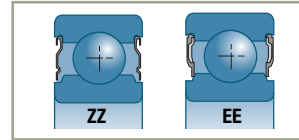

A given bearing can have a combination of types of protection and sealing, for example an E seal and a Z shield (suffix EZ).

Bearing featuring

- one or two seals or two shields are supplied pre-lubricated with general-purpose grease
- unilateral protection by a single Z shield are not supplied pre-lubricated

■ Special sealing and protection

SNR proposes a range of seals for various applications:

- high speed of rotation and temperature
- reinforced sealing
- filter function for contaminated oil applications
- speed-sensing function

SNR can study jointly with the user special seals for mass production applications.

■ Groove for snap ring

Bearings are supplied with or without a snap ring.

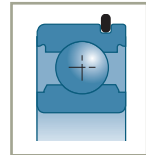

Tolerances and clearances

■ Tolerances

Manufactured within the normal tolerance classes.

Single-row ball bearings can be supplied on request in tolerance classes ISO 6 and 5 for all or specific characteristics (e.g. bore or radial run-out in tolerance class 6).

■ Internal radial clearance

All standard production bearings are in the normal clearance group N. The other groups can be supplied on request.

For single-row radial ball bearings with a tapered bore, SNR ROULEMENTS has adopted group 3 (C3) as the standard

clearance to allow for a greater reduction in clearance resulting from fitting on a tapered seat.

The radial clearance leads to an axial clearance; a simple formula can be used to calculate the approximate size of the theoretical axial clearance J_a as a function of the operating radial clearance J_r .

$$J_a = (J_r (D-d) / 20)^{1/2}$$

Single-row radial ball bearings (continued)

■ Series 60-62-63-64-160-618-619-622-623-42-43



Bore diameter d (mm)	Group 2		Group N		Group 3		Group 4		Group 5	
	min	max	min	max	min	max	min	max	min	max
2.5 <d≤ 6	0	7	2	13	8	23	–	–	–	–
6 <d≤ 10	0	7	2	13	8	23	14	29	20	37
10 <d≤ 18	0	9	3	18	11	25	18	33	25	45
18 <d≤ 24	0	10	5	20	13	28	20	36	28	48
24 <d≤ 30	1	11	5	20	13	28	23	41	30	53
30 <d≤ 40	1	11	6	20	15	33	28	46	40	64
40 <d≤ 50	1	11	6	23	18	36	30	51	45	73
50 <d≤ 65	1	15	8	28	23	43	38	61	55	90
65 <d≤ 80	1	15	10	30	25	51	46	71	65	105
80 <d≤ 100	1	18	12	36	30	58	53	84	75	120
100 <d≤ 120	2	20	15	41	36	66	61	97	90	140
120 <d≤ 140	2	23	18	48	41	81	71	114	105	160
140 <d≤ 160	2	23	18	53	46	91	81	130	120	180
160 <d≤ 180	2	25	20	61	53	102	91	147	135	200
180 <d≤ 200	2	30	25	71	63	117	107	163	150	230
200 <d≤ 225	2	35	25	85	75	140	125	195	175	265
225 <d≤ 250	2	40	30	95	85	160	145	225	205	300
250 <d≤ 280	2	45	35	105	90	170	155	245	225	340
280 <d≤ 315	2	55	40	115	100	190	175	270	245	370
315 <d≤ 355	3	60	45	125	110	210	195	300	275	410
355 <d≤ 400	3	70	55	145	130	240	225	340	315	460
400 <d≤ 450	3	80	60	170	150	270	250	380	350	510
450 <d≤ 500	3	90	70	190	170	300	280	420	390	570
500 <d≤ 560	10	100	80	210	190	330	310	470	440	630
560 <d≤ 630	10	110	90	230	210	360	340	520	490	690
630 <d≤ 710	20	130	110	260	240	400	380	570	540	760
710 <d≤ 800	20	140	120	290	270	450	430	630	600	840

Value in μm



Design criteria

- **Bearing life**

- **Residual radial clearance**

- **Bearings operating under heavy axial loads**

The performance of bearings operating under heavy axial loads can be improved by increasing the radial clearance in order to create a contact angle in operation. The axial load F_a must not exceed a mean value of $0.5 C_0$.

This type of operation has to be studied according to the loading conditions and dimensions of the bearings. Consult with SNR.

- **Unit made up by two side-by-side bearings**

Each pair of bearings is calculated like a single bearing.

Suffixes and prefixes

A	Increased capacity
C3	Radial clearance of the group ISO 3
C4	Radial clearance of the group ISO 4
D..	Special grease
E - EE	Sealing by nitrile seal
E3 -EE3	Sealing by high temperature seal
F...	Special function
G14 - G15	Polyamide cage
2RS	Two-side sealing for thin section ball bearings
2Z	Two-side protection for thin section ball bearings
Z -ZZ	Protection by metal shields
Y	Brass cage

Single-row radial ball bearings (continued)

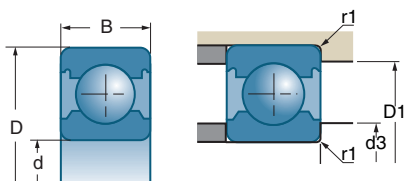

d		D	B						
				mm	References	mm	mm	10°N	10°N
3	623	10	4	0.64	0.23	70000	80000		
4	624	13	5	1.30	0.49	54000	63000		
	634	16	5	1.88	0.68	45000	53000		
5	625	16	5	1.88	0.68	47000	55000		
	635	19	6	2.46	1.05	34000	40000		
6	626	19	6	2.46	1.05	35000	41000		
7	607	19	6	2.46	1.05	37000	46000		
	627	22	7	3.30	1.36	32000	37000		
8	608	22	7	3.30	1.36	34000	42000		
9	609	24	7	3.65	1.64	30000	37000		
	629	26	8	4.60	1.97	26000	30000		
10	61800	19	5	1.83	0.92	34000	42000		
	61900	22	6	2.70	1.27	31000	38000		
	6000	26	8	4.60	1.97	27000	34000		
	6200	30	9	6.00	2.65	23000	27000		
	6300	35	11	7.60	3.45	19000	24000		
12	61801	21	5	1.92	1.04	30000	37000		
	61901	24	6	2.90	1.46	27000	34000		
	6001	28	8	5.10	2.37	25000	32000		
	6201	32	10	6.80	3.05	21000	25000		
	6301	37	12	9.70	4.20	18000	23000		
15	61802	24	5	2.08	1.26	25000	31000		
	61902	28	7	4.35	2.25	23000	28000		
	16002	32	8	5.60	2.85	22000	26000		
	6002	32	9	5.60	2.85	21000	26000		
	6202	35	11	7.70	3.75	19000	22000		
	6302	42	13	11.40	5.40	15000	19000		
17	61803	26	5	2.23	1.46	23000	28000		
	61903	30	7	4.60	2.55	21000	26000		
	16003	35	8	6.00	3.25	20000	24000		
	6003	35	10	6.00	3.25	19000	24000		



* These are the speed limits according to the SNR concept (see pages 85 to 87).

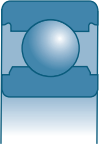

Characteristics

■ Open bearing

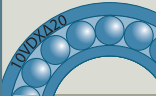

	d3 min	D1 max	r1 max	
References	mm	mm	mm	kg
623	5.0	8.0	0.10	0.002
624	5.5	11.5	0.20	0.003
634	6.0	14.0	0.30	0.005
625	7.0	14.0	0.30	0.007
635	7.0	17.0	0.30	0.010
626	8.0	17.0	0.30	0.009
607	9.0	17.0	0.30	0.008
627	9.0	20.0	0.30	0.012
608	10.0	20.0	0.30	0.012
609	11.0	22.0	0.30	0.015
629	12.9	22.1	0.30	0.020
61800	12.0	17.0	0.30	0.005
61900	12.0	20.0	0.30	0.013
6000	12.0	24.0	0.30	0.019
6200	14.0	26.0	0.60	0.033
6300	14.0	31.0	0.60	0.055
61801	14.0	19.0	0.30	0.006
61901	14.0	22.0	0.30	0.014
6001	14.0	26.0	0.30	0.022
6201	16.0	28.0	0.60	0.038
6301	17.9	31.5	1.00	0.060
61802	17.0	22.0	0.30	0.007
61902	17.0	26.0	0.30	0.015
16002	17.0	30.0	0.30	0.026
6002	17.0	30.0	0.30	0.030
6202	19.0	31.2	0.60	0.044
6302	21.0	36.3	1.00	0.083
61803	19.0	24.0	0.30	0.008
61903	19.0	28.0	0.30	0.016
16003	19.0	33.0	0.30	0.032
6003	19.0	33.0	0.30	0.039

Single-row radial ball bearings (continued)

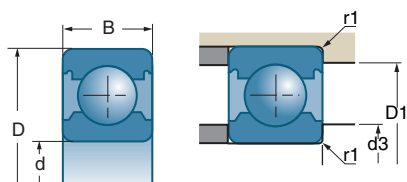



d		D	B				
				10°N	10°N	rpm*	rpm*
mm	References	mm	mm				
17	6203	40	12	9.60	4.80	16000	19000
	6303	47	14	13.60	6.60	14000	17000
	6403	62	17	22.70	10.80	12000	14000
20	61804	32	7	2.95	1.87	19500	23500
	61904	37	9	6.40	3.70	17500	20500
	16004	42	8	6.80	4.10	17000	20000
	6004	42	12	9.40	5.00	16000	20000
	6204	47	14	12.80	6.70	13000	16000
	6304	52	15	15.90	7.90	12000	15000
	6404	72	19	29.50	15.50	9600	12000
25	61805	37	7	4.30	2.95	17000	20000
	61905	42	9	7.00	4.55	15000	18000
	16005	47	8	10.10	5.90	14000	17000
	6005	47	12	10.10	5.90	13000	17000
	6205	52	15	14.00	7.90	12000	14000
	6305	62	17	22.40	11.50	10000	13000
	6405	80	21	36.00	19.30	8600	11000
30	61806	42	7	4.55	3.40	14500	17500
	61906	47	9	7.20	4.35	13500	16000
	16006	55	9	11.20	7.40	11000	14000
	6006	55	13	13.20	8.30	11000	14000
	6206	62	16	19.50	11.30	10000	12000
	6306	72	19	28.00	15.80	8900	10000
	6406	90	23	43.50	23.80	7600	9300
35	61807	47	7	4.75	3.80	13000	15500
	61907	55	10	9.60	5.90	11500	14000
	16007	62	9	12.10	8.80	10000	12000
	6007	62	14	16.00	10.30	10000	12000
	6207	72	17	25.50	15.30	8900	10000
	6307	80	21	33.50	19.20	8000	9800
	6407	100	25	55.00	31.00	6800	8300
40	61808	52	7	4.90	4.15	11500	14000
	61908	62	12	12.20	7.70	10000	12000
	16008	68	9	13.20	10.30	9800	11000
	6008	68	15	16.80	11.50	9200	11000
	6208	80	18	29.00	17.90	7800	9100
	6308	90	23	40.50	23.90	7000	8200
	6408	110	27	63.00	36.50	6200	7600

* These are the speed limits according to the SNR concept (see pages 85 to 87).

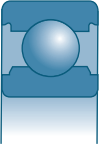

■ Open bearing (continued)

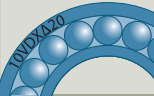

	d3 min	D1 max	r1 max	
References	mm	mm	mm	kg
6203	21.0	36.0	0.60	0.067
6303	23.0	41.0	1.00	0.113
6403	25.0	54.0	1.10	0.272
61804	22.2	29.8	0.30	0.018
61904	22.2	34.8	0.30	0.036
16004	22.0	40.0	0.30	0.050
6004	24.0	38.0	0.60	0.068
6204	26.0	41.3	1.00	0.108
6304	27.0	45.0	1.10	0.140
6404	28.0	64.0	1.10	0.408
61805	27.2	34.8	0.30	0.022
61905	27.2	39.8	0.30	0.042
16005	27.0	45.0	0.30	0.056
6005	29.0	43.0	0.60	0.083
6205	31.0	46.5	1.00	0.128
6305	32.0	55.0	1.10	0.183
6405	35.0	70.0	1.50	0.534
61806	32.2	39.8	0.30	0.026
61906	32.3	44.8	0.30	0.048
16006	32.0	53.0	0.30	0.082
6006	37.5	50.0	1.00	0.111
6206	36.0	56.0	1.00	0.199
6306	37.0	65.0	1.10	0.346
6406	40.0	80.0	1.50	0.734
61807	37.2	44.8	0.30	0.029
61907	38.6	51.4	0.60	0.074
16007	37.0	60.0	0.30	0.105
6007	40.0	57.0	1.00	0.153
6207	42.0	65.0	1.10	0.285
6307	44.0	71.0	1.50	0.446
6407	45.0	90.0	1.50	0.962
61808	42.2	49.8	0.30	0.035
61908	43.6	58.4	0.60	0.110
16008	42.0	66.0	0.30	0.120
6008	45.0	63.0	1.00	0.192
6208	47.0	73.0	1.10	0.364
6308	49.0	81.0	1.50	0.612
6408	52.0	98.0	2.00	1.216

Single-row radial ball bearings (continued)

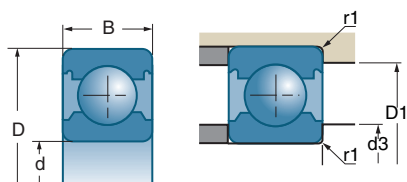



d		D	B				
				10°N	10°N	rpm*	rpm*
mm	References	mm	mm				
45	61809	58	7	6.60	5.90	9600	11000
	61909	68	12	14.10	10.90	9100	11000
	16009	75	10	15.90	11.90	9600	11000
	6009	75	16	21.00	15.20	8300	10000
	6209	85	19	31.50	20.70	7100	8300
	6309	100	25	53.00	31.50	6400	7900
	6409	120	29	77.00	45.00	5600	6900
50	61810	65	7	6.80	6.30	8600	10000
	61910	72	12	13.40	9.60	7900	9500
	16010	80	10	16.10	13.10	8100	9600
	6010	80	16	22.00	16.20	7600	9500
	6210	90	20	35.00	23.20	6800	8200
	6310	110	27	62.00	38.00	5600	6900
	6410	130	31	87.00	52.00	5200	6300
55	61811	72	9	9.10	8.50	7700	9600
	61911	80	13	16.60	14.10	7700	9200
	16011	90	11	19.40	16.20	7300	8600
	6011	90	18	30.50	22.00	6800	8500
	6211	100	21	43.50	29.00	6100	7400
	6311	120	29	71.00	44.50	5300	6500
	6411	140	33	100.00	62.00	4800	5800
60	61812	78	10	11.80	11.10	7100	8800
	61912	85	13	16.40	14.20	7200	8600
	16012	95	11	20.00	17.50	6800	8100
	6012	95	18	29.50	23.20	6400	8000
	6212	110	22	52.00	36.00	5500	6600
	6312	130	31	82.00	52.00	4800	5900
	6412	150	35	104.00	68.00	4200	5100
65	61813	85	10	12.30	12.00	6600	8100
	61913	90	13	17.40	16.00	6800	8100
	16013	100	11	21.70	18.90	6400	7600
	6013	100	18	30.50	25.00	6100	7500
	6213	120	23	57.00	40.00	5100	6200
	6313	140	33	93.00	60.00	4500	5500
	6413	160	37	113.00	77.00	4100	5000

* These are the speed limits according to the SNR concept (see pages 85 to 87).

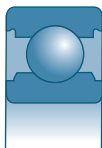

■ Open bearing (continued)

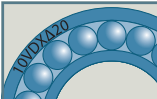

	d3 min	D1 max	r1 max	
References	mm	mm	mm	kg
61809	47.6	55.4	0.30	0.039
61909	49.2	63.8	0.60	0.130
16009	49.0	71.0	0.60	0.167
6009	50.0	70.0	1.00	0.243
6209	52.0	78.0	1.10	0.416
6309	54.0	91.0	1.50	0.825
6409	57.0	108.0	2.00	1.526
61810	52.6	62.4	0.30	0.052
61910	54.2	67.8	0.60	0.130
16010	54.0	76.0	0.60	0.181
6010	55.0	75.0	1.00	0.250
6210	57.0	83.0	1.10	0.453
6310	61.0	99.0	2.00	1.070
6410	64.0	116.0	2.10	1.880
61811	57.6	69.4	0.30	0.084
61911	60.4	74.6	1.00	0.180
16011	59.0	86.0	0.60	0.266
6011	61.0	84.0	1.10	0.362
6211	64.0	91.0	1.50	0.603
6311	66.0	109.0	2.00	1.347
6411	69.0	126.0	2.10	2.302
61812	62.6	75.4	0.30	0.105
61912	65.4	79.6	1.00	0.190
16012	64.0	91.0	0.60	0.283
6012	66.0	89.0	1.10	0.411
6212	69.0	101.0	1.50	0.785
6312	73.0	117.0	2.10	1.680
6412	74.0	136.0	2.10	2.870
61813	69.2	80.8	0.60	0.130
61913	70.4	84.6	1.00	0.200
16013	69.0	96.0	0.60	0.300
6013	71.0	94.0	1.10	0.444
6213	74.0	111.0	1.50	0.991
6313	78.0	127.0	2.10	2.077
6413	79.0	146.0	2.10	3.420

Single-row radial ball bearings (continued)

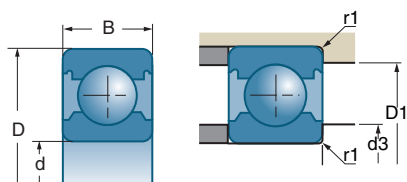



d		D	B				
				10°N	10°N	rpm*	rpm*
mm	References	mm	mm				
70	61814	90	10	12.40	12.40	6100	7600
	61914	100	16	23.70	18.30	6100	7300
	16014	110	13	28.00	25.00	5800	7000
	6014	110	20	38.00	31.00	5500	6800
	6214	125	24	62.00	44.00	4900	5800
	6314	150	35	104.00	68.00	4200	5100
	6414	180	42	143.00	103.00	3700	4500
75	61815	95	10	12.90	13.30	5800	7100
	61915	105	16	24.40	22.50	5800	7000
	16015	115	13	28.50	27.00	5500	6600
	6015	115	20	39.50	33.50	5200	6500
	6215	130	25	67.00	48.00	4600	5600
	6315	160	37	113.00	77.00	3900	4800
80	61816	100	10	13.00	13.80	5500	6700
	61916	110	16	25.00	23.90	5500	6600
	16016	125	14	32.00	31.00	5100	6000
	6016	125	22	47.50	39.50	4800	6000
	6216	140	26	73.00	53.00	4300	5200
	6316	170	39	123.00	86.00	3700	4500
	6416	200	48	163.00	125.00	3300	4000
85	61817	110	13	19.30	19.80	5000	6200
	16017	130	14	34.00	33.50	4900	5800
	6017	130	22	49.50	43.00	4600	5700
	6217	150	28	84.00	62.00	4000	4800
	6317	180	41	133.00	97.00	3500	4300
90	61818	115	13	19.50	20.50	4800	5900
	16018	140	16	41.50	39.50	4600	5400
	6018	140	24	58.00	49.50	4300	5300
	6218	160	30	96.00	71.00	3800	4600
	6318	190	43	143.00	107.00	3300	4000
95	61819	120	13	19.80	21.30	4600	5600
	6019	145	24	60.00	54.00	4000	5000
	6219	170	32	109.00	82.00	3600	4300
	6319	200	45	144.00	113.00	3100	3800

* These are the speed limits according to the SNR concept (see pages 85 to 87).

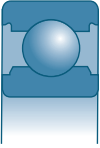

■ Open bearing (continued)

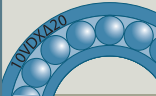

	d3 min	D1 max	r1 max	
References	mm	mm	mm	kg
61814	74.2	85.8	0.60	0.140
61914	75.4	94.6	1.00	0.360
16014	74.0	106.0	0.60	0.438
6014	76.0	104.0	1.10	0.610
6214	79.0	116.0	1.50	1.055
6314	83.0	137.0	2.10	2.580
6414	86.0	164.0	3.00	5.090
61815	79.2	90.8	0.60	0.150
61915	80.4	99.6	1.00	0.360
16015	79.0	111.0	0.60	0.463
6015	81.0	109.0	1.10	0.640
6215	84.0	121.0	1.50	1.190
6315	88.0	147.0	2.10	3.031
61816	84.2	95.2	0.60	0.155
61916	85.4	104.6	1.00	0.380
16016	84.0	121.0	0.60	0.609
6016	86.0	119.0	1.10	0.870
6216	91.0	129.0	2.00	1.420
6316	93.0	157.0	2.10	3.605
6416	96.0	184.0	3.00	8.070
61817	90.4	104.6	1.00	0.270
16017	89.0	126.0	0.60	0.666
6017	91.0	124.0	1.10	0.900
6217	96.0	139.0	2.00	1.820
6317	99.0	166.0	3.00	4.210
61818	95.4	109.6	1.00	0.280
16018	95.0	135.0	1.00	0.866
6018	98.0	132.0	1.50	1.175
6218	101.0	149.0	2.00	2.180
6318	104.0	176.0	3.00	5.020
61819	100.4	114.6	1.00	0.295
6019	103.0	137.0	1.50	1.220
6219	108.0	157.0	2.10	2.800
6319	109.0	186.0	3.00	6.140

Single-row radial ball bearings (continued)

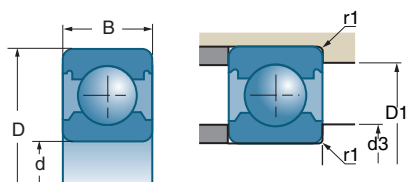



d		D	B				
				mm	mm	10°N	10°N
100	61820	125	13	20.10	22.00	4400	5400
	16020	150	16	44.00	44.50	4200	5000
	6020	150	24	60.00	54.00	4000	4900
	6220	180	34	122.00	93.00	3400	4100
	6320	215	47	164.00	135.00	2900	3600
105	61821	130	13	20.80	23.60	4200	5100
	6021	160	26	72.00	66.00	3700	4600
	6221	190	36	133.00	104.00	3200	3900
110	61822	140	16	28.00	30.50	3900	4800
	16022	170	19	57.00	57.00	3700	4500
	6022	170	28	82.00	73.00	3500	4400
	6222	200	38	144.00	117.00	3100	3700
	6322	240	50	189.00	165.00	2600	3200
120	61824	150	16	29.00	33.00	3600	4500
	16024	180	19	61.00	64.00	3500	4200
	6024	180	28	85.00	79.00	3300	4100
	6224	215	40	145.00	123.00	2800	3400
	6324	260	55	212.00	190.00	2400	3000
130	61826	165	18	38.00	43.00	3600	4400
	16026	200	22	79.00	82.00	3200	3800
	6026	200	33	106.00	101.00	3000	3700
	6226	230	40	167.00	146.00	2600	3000
	6326	280	58	229.00	214.00	2200	2700
140	61828	175	18	39.00	46.00	3400	4100
	16028	210	22	81.00	87.00	3000	3600
	6028	210	33	109.00	107.00	2800	3500
	6228	250	42	177.00	165.00	2400	5400
	6328	300	62	255.00	246.00	2100	2600
150	61830	190	20	51.00	60.00	3100	3800
	6030	225	35	123.00	124.00	2600	3300
	6230	270	45	176.00	168.00	2200	2700
	6330	320	65	280.00	290.00	1900	2400
160	61832	200	20	52.00	62.00	3000	3600
	16032	240	25	102.00	113.00	2600	3100

* These are the speed limits according to the SNR concept (see pages 85 to 87).

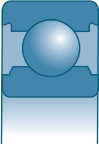

■ Open bearing (continued)

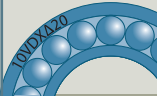

	d3 min	D1 max	r1 max	
References	mm	mm	mm	kg
61820	105.4	119.6	1.00	0.310
16020	105.0	145.0	1.00	0.929
6020	108.0	142.0	1.50	1.260
6220	113.0	167.0	2.10	3.129
6320	114.0	201.0	3.00	7.560
61821	110.4	124.6	1.00	0.330
6021	114.0	151.0	2.00	1.590
6221	118.0	177.0	2.10	3.860
61822			1.00	0.500
16022	115.0	165.0	1.00	1.510
6022	119.0	161.0	2.00	1.490
6222	123.0	187.0	2.10	3.860
6322	124.0	226.0	3.00	10.300
61824	125.4	144.6	1.00	0.550
16024	125.0	175.0	1.00	1.600
6024	129.0	171.0	2.00	2.090
6224	133.0	202.0	2.10	5.600
6324	134.0	246.0	3.00	12.800
61826	137.6	157.4	1.10	0.780
16026	136.0	194.0	1.10	2.410
6026	138.8	191.2	2.00	3.270
6226	144.0	216.0	3.00	6.220
6326	148.0	262.0	4.00	18.200
61828	147.6	167.4	1.10	0.830
16028	146.0	204.0	1.00	2.530
6028	149.0	201.0	2.00	3.570
6228	154.0	236.0	3.00	7.470
6328	157.0	283.0	3.00	22.100
61830	157.6	182.4	1.10	1.350
6030	159.0	216.0	2.10	4.380
6230	164.0	256.0	2.50	10.300
6330	167.0	303.0	3.00	26.600
61832	167.6	192.4	1.10	1.400
16032	167.0	233.0	1.50	3.770

Single-row radial ball bearings (continued)

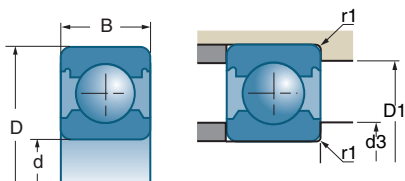



d		D	B				
				10°N	10°N	rpm*	rpm*
160	References 6032 6232 6332	240 290 340	38 48 68	137.00 199.00 300.00	135.00 203.00 325.00	2500 2100 1800	3000 2500 2200
170	61834 16034 6034 6234	215 260 260 310	22 28 42 52	61.00 123.00 168.00 212.00	73.00 136.00 172.00 224.00	2800 2400 2300 2000	3300 2900 2800 2400
180	61836 16036 6036 6236	225 280 280 320	22 31 46 52	62.00 131.00 188.00 226.00	76.00 146.00 196.00 244.00	2700 2300 2100 1900	3200 2800 2700 2300
190	61838 16038 6038 6238	240 290 290 340	24 31 46 55	69.00 149.00 195.00 255.00	85.00 167.00 213.00 280.00	2500 2200 2000 1800	3000 2600 2500 2100
200	61840 16040 6040 6240	250 310 310 360	24 34 51 58	70.00 175.00 214.00 270.00	88.00 202.00 238.00 310.00	2400 2000 1900 1700	2900 2400 2400 2000
220	61844	270	24	73.00	97.00	2200	2600
240	61848	300	28	92.00	120.00	2000	2400
260	61852	320	28	94.00	128.00	1900	2200
280	61856	350	33	126.00	170.00	1700	2000
300	61860	380	38	148.00	198.00	1600	1900
320	61864	400	38	154.00	213.00	1500	1800
340	61868	420	38	155.00	219.00	1400	1700
360	61872	440	38	160.00	234.00	1350	1600

* These are the speed limits according to the SNR concept (see pages 85 to 87).



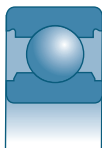

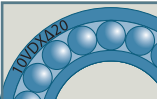
■ Open bearing (continued)

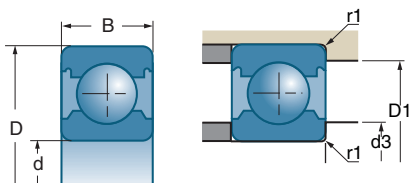

	d3 min	D1 max	r1 max	
References	mm	mm	mm	kg
6032	170.0	230.0	2.10	6.120
6232	174.0	276.0	2.50	14.300
6332	177.0	323.0	3.00	31.500
61834	177.6	207.4	1.10	1.600
16034	177.0	253.0	1.50	5.130
6034	180.0	250.0	2.10	8.200
6234	187.0	293.0	3.00	17.700
61836	187.6	217.4	1.10	2.000
16036	189.0	271.0	2.00	6.920
6036	190.0	270.0	2.10	10.700
6236	197.0	303.0	3.00	18.300
61838	199.0	231.0	1.50	2.700
16038	199.0	281.0	2.00	7.090
6038	200.0	280.0	2.10	11.270
6238	207.0	323.0	3.00	22.200
61840	209.0	241.0	1.50	2.700
16040	219.0	301.0	2.00	9.110
6040	210.0	300.0	2.10	14.430
6240	217.0	343.0	3.00	26.500
61844	229.0	261.0	1.50	2.900
61848	251.0	289.0	2.00	4.500
61852	271.0	309.0	2.00	4.800
61856	291.0	339.0	2.00	7.300
61860	314.0	366.0	2.10	10.500
61864	334.0	386.0	2.10	11.000
61868	354.0	406.0	2.10	11.500
61872	374.0	426.0	2.10	12.000

Single-row radial ball bearings (continued)

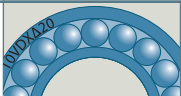



d		D	B				
				10 ⁶ N	10 ⁷ N	rpm EE/2RS*	rpm ZZ*
mm	References	mm	mm				
3	623 EE 623 ZZ	10	4	0.64	0.23	47000	70000
4	604 ZZ	12	4	0.71	0.27		60000
	624 EE 624 ZZ	13	5	1.3	0.5	36000	54000
	634 EE 634 ZZ	16	5	1.88	0.68	25000	46000
5	625 EE 625 ZZ	16	5	1.88	0.68	31000	47000
	635 ZZ	19	6	2.46	1.05		34000
6	626 EE 626 ZZ	19	6	2.46	1.05	23000	35000
7	607 EE 607 ZZ	19	6	2.46	1.05	25000	37000
	627 EE 627 ZZ	22	7	3.3	1.36	21000	32000
8	608 EE 608 ZZ	22	7	3.3	1.36	23000	34000
9	609 EE 609 ZZ	24	7	3.65	1.64	20000	30000
	629 EE 629 ZZ	26	8	4.6	1.97	17000	26000
10	61800 EE 61800 ZZ	19	5	1.83	0.92	22000	34000
	61900 EE 61900 ZZ	22	6	2.7	1.27	20000	31000
	6000 EE 6000 ZZ	26	8	4.6	1.97	18000	27000
	63000 EE	26	12	4.6	1.97	18000	
	6200 EE 6200 ZZ	30	9	6	2.65	15000	23000
	62200 EE 62200 ZZ	30	14	6	2.65	15000	18000
	6300 EE 6300 ZZ	35	11	7.6	3.45	13000	20000
	62300 EE	35	17	8.1	3.45	13000	
	12	61801 EE 61801 ZZ	21	5	1.92	1.04	20000
61901 EE 61901 ZZ	24	6	2.9	1.46	18000	27000	
6001 EE 6001 ZZ	28	8	5.1	2.37	16000	25000	
63001 EE	28	12	5.1	2.37	16000		
6201 EE 6201 ZZ	32	10	6.8	3.05	14000	21000	
62201 EE	32	14	6.9	3.1	14000		
6301 EE 6301 ZZ	37	12	9.7	4.2	12000	18000	
62301 EE	37	17	9.7	4.2	12000		
15	61802 EE 61802 ZZ	24	5	2.08	1.26	17000	25000
	61902 EE 61902 ZZ	28	7	4.35	2.25	15000	23000
	6002 EE 6002 ZZ	32	9	5.6	2.85	14000	21000
	63002 EE	32	13	5.6	2.85	14000	

* These are the speed limits according to the SNR concept (see pages 85 to 87).

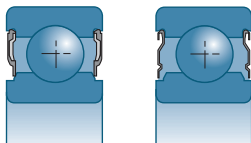

■ Sealed and shielded bearing



References		d3 min	D1 max	r1 max	
		mm	mm	mm	kg
623 EE	623 ZZ	5.0	8.0	0.10	0.0015
624 EE 634 EE	604 ZZ	5.4	10.6	0.20	0.0021
	624 ZZ	5.5	11.5	0.20	0.0060
	634 ZZ	6.0	14.0	0.30	0.0050
625 EE	625 ZZ	7.0	14.0	0.30	0.0070
	635 ZZ	7.0	17.0	0.30	0.0100
626 EE	626 ZZ	8.0	17.0	0.30	0.0090
607 EE	607 ZZ	9.0	17.0	0.30	0.0120
627 EE	627 ZZ	9.0	20.0	0.30	0.0120
608 EE	608 ZZ	10.0	20.0	0.30	0.0120
609 EE 629 EE	609 ZZ	11.0	22.0	0.30	0.0140
	629 ZZ	12.9	22.1	0.30	0.0200
61800 EE	61800 ZZ	12.0	17.0	0.30	0.0050
61900 EE	61900 ZZ	12.0	20.0	0.30	0.0130
6000 EE	6000 ZZ	12.0	24.0	0.30	0.0190
63000 EE		12.0	24.0	0.30	0.0280
6200 EE	6200 ZZ	14.0	26.0	0.60	0.0330
62200 EE	62200 ZZ	14.0	26.0	0.60	0.0480
6300 EE	6300 ZZ	14.0	31.0	0.60	0.0550
62300 EE		14.0	31.0	0.60	0.0790
61801 EE	61801 ZZ	14.0	19.0	0.30	0.0060
61901 EE	61901 ZZ	14.0	22.0	0.30	0.0140
6001 EE	6001 ZZ	14.0	26.0	0.30	0.0220
63001 EE		14.0	26.0	0.30	0.0290
6201 EE	6201 ZZ	16.0	28.0	0.60	0.0380
62201 EE		16.0	28.0	0.60	0.0490
6301 EE	6301 ZZ	17.9	31.5	1.00	0.0620
62301 EE		17.9	31.5	1.00	0.0700
61802 EE	61802 ZZ	17.0	22.0	0.30	0.0070
61902 EE	61902 ZZ	17.0	26.0	0.30	0.0150
6002 EE	6002 ZZ	17.0	30.0	0.30	0.0300
63002 EE		17.0	30.0	0.30	0.0440

Single-row radial ball bearings (continued)

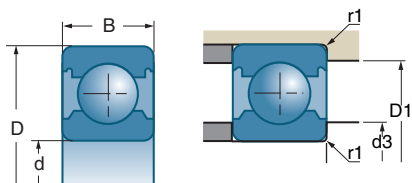



d			D	B					
	mm	References			mm	mm	10°N	10°N	rpm EE/2RS*
15	6202 EE	6202 ZZ	35	11	7.7	3.75	12000	19000	
	62202 EE		35	14	7.7	3.75	12000		
	6302 EE	6302 ZZ	42	13	11.3	5.4	11000	16000	
	62302 EE		42	17	11.3	5.4	11000		
17	61803 EE	61803 ZZ	26	5	2.23	1.46	15000	23000	
	61903 EE	61903 ZZ	30	7	4.6	2.55	14000	21000	
	6003 EE	6003 ZZ	35	10	6	3.25	12000	19000	
	63003 EE		35	14	6	3.25	12000		
	6203 EE	6203 ZZ	40	12	9.5	4.75	10000	16000	
	62203 EE		40	16	9.5	4.75	11000		
	6303 EE	6303 ZZ	47	14	13.6	6.6	9300	14000	
	62303 EE		47	19	13.6	6.6	9400		
	20	61804 2RS	61804 ZZ	32	7	2.95	1.87	11500	19500
		61904 2RS	61904 ZZ	37	9	6.4	3.7	11000	17500
6004 EE		6004 ZZ	42	12	9.4	5	10000	16000	
63004 EE			42	16	9.4	5	10000		
6204 EE		6204 ZZ	47	14	12.8	6.6	9300	14000	
62204 EE			47	18	12.8	6.6	9500		
6304 EE		6304 ZZ	52	15	15.9	7.9	8600	12000	
62304 EE			52	21	15.9	7.9	8600		
25	61805 2RS	61805 ZZ	37	7	4.3	2.95	9800	17000	
	61905 2RS	61905 ZZ	42	9	7	4.55	9800	15000	
	6005 EE	6005 ZZ	47	12	10.1	5.8	9300	14000	
	63005 EE		47	16	10.1	5.8	9300		
	6205 EE	6205 ZZ	52	15	14	7.9	8100	12000	
	62205 EE		52	18	14	7.9	8100		
	6305 EE	6305 ZZ	62	17	23.6	12.1	7100	10000	
	62305 EE		62	24	23.6	12.1	7100		
30	61806 2RS	61806 ZZ	42	7	4.55	3.4	8400	14500	
	61906 2RS	61906 ZZ	47	9	7.2	5	8100	13500	
	6006 EE	6006 ZZ	55	13	13.2	8.3	7800	11000	
	63006 EE		55	19	13.2	8.3	7800		
	6206 EE	6206 ZZ	62	16	19.5	11.3	6800	10000	
	62206 EE		62	20	19.5	11.3	6900		
	6306 EE	6306 ZZ	72	19	27	15.2	5800	8900	
	62306 EE		72	27	28	15.8	6000		

* These are the speed limits according to the SNR concept (see pages 85 to 87).

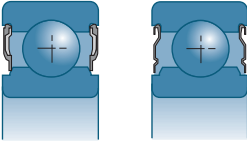

■ Sealed and shielded bearing (continued)



		d3 min	D1 max	r1 max	
References		mm	mm	mm	kg
6202 EE	6202 ZZ	19.0	31.2	0.60	0.0460
62202 EE		19.0	31.2	0.60	0.0530
6302 EE	6302 ZZ	21.0	36.3	1.00	0.0830
62302 EE		21.0	36.3	1.00	0.1080
61803 EE	61803 ZZ	19.0	24.0	0.30	0.0080
61903 EE	61903 ZZ	19.0	28.0	0.30	0.0160
6003 EE	6003 ZZ	19.0	33.0	0.30	0.0390
63003 EE		19.0	33.0	0.30	0.0550
6203 EE	6203 ZZ	21.0	36.0	0.60	0.0677
62203 EE		21.0	36.0	0.60	0.0820
6303 EE	6303 ZZ	23.0	41.0	1.00	0.1130
62303 EE		23.0	41.0	1.00	0.1460
61804 2RS	61804 ZZ	22.2	29.8	0.30	0.0180
61904 2RS	61904 ZZ	22.2	34.8	0.30	0.0360
6004 EE	6004 ZZ	24.0	38.0	0.60	0.0680
63004 EE		24.0	38.0	0.60	0.0820
6204 EE	6204 ZZ	26.0	41.3	1.00	0.1000
62204 EE		26.0	41.3	1.00	0.1310
6304 EE	6304 ZZ	27.0	45.0	1.10	0.1470
62304 EE		27.0	45.0	1.10	0.1970
61805 2RS	61805 ZZ	27.2	34.8	0.30	0.0220
61905 2RS	61905 ZZ	27.2	39.8	0.30	0.0420
6005 EE	6005 ZZ	29.0	43.0	0.60	0.0800
63005 EE		29.0	43.0	0.60	0.1050
6205 EE	6205 ZZ	31.0	46.5	1.00	0.1270
62205 EE		31.0	46.5	1.00	0.1480
6305 EE	6305 ZZ	32.0	55.0	1.10	0.2250
62305 EE		32.0	55.0	1.10	0.3170
61806 2RS	61806 ZZ	32.2	39.8	0.30	0.0260
61906 2RS	61906 ZZ	32.3	44.8	0.30	0.0480
6006 EE	6006 ZZ	35.0	50.0	1.00	0.1160
63006 EE		35.0	50.0	1.00	0.1660
6206 EE	6206 ZZ	36.0	56.0	1.00	0.1990
62206 EE		36.0	56.0	1.00	0.2360
6306 EE	6306 ZZ	37.0	65.0	1.10	0.3500
62306 EE		37.0	65.0	1.10	0.4730

Single-row radial ball bearings (continued)

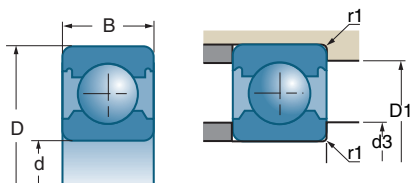

d		D	B				
				mm	mm	mm	mm
35	61807 2RS 61807 ZZ	47	7	4.75	3.8	7300	13000
	61907 2RS	55	10	9.6	5.9	8000	
	6007 EE 6007 ZZ	62	14	16	10.3	6800	10000
	63007 EE	62	20	16	10.3	6800	
	6207 EE 6207 ZZ	72	17	25.5	15.3	5900	8900
	62207 EE	72	23	25.5	15.3	5900	
	6307 EE 6307 ZZ	80	21	33.5	19.2	5300	8000
	62307 EE	80	31	33.5	19.2	5300	
40	61808 2RS 61808 ZZ	52	7	4.9	4.15	6500	11500
	6008 EE 6008 ZZ	68	15	16.8	11.5	6100	9200
	63008 EE	68	21	16.8	11.5	6100	
	6208 EE 6208 ZZ	80	18	29.5	18.1	5200	7800
	62208 EE	80	23	29	17.9	5300	
	6308 EE 6308 ZZ	90	23	40.5	23.9	4700	7000
	62308 EE	90	33	40.5	23.9	4800	
45	61809 EE 61809 ZZY	58	7	6.6	5.9	6400	10500
	6009 EE 6009 ZZ	75	16	21	15.2	5500	8300
	6209 EE 6209 ZZ	85	19	32.5	20.5	4900	7300
	62209 EE	85	23	32.5	20.5	4900	
	6309 EE 6309 ZZ	100	25	53	31.5	4200	6200
50	61810 EE 61810 ZZY	65	7	6.8	6.3	5700	9300
	6010 EE 6010 ZZ	80	16	21.8	16.6	5000	7600
	6210 EE 6210 ZZ	90	20	35	23.2	4500	6800
	62210 EE	90	23	35	23.2	4500	
	6310 EE 6310 ZZ	110	27	62	38	3700	5600
55	61811 EE 61811 ZZY	72	9	9.1	8.5	5100	8400
	6011 EE 6011 ZZ	90	18	28.5	21.3	4500	6800
	6211 EE 6211 ZZ	100	21	43.5	29	4100	6100
	6311 EE 6311 ZZ	120	29	71	44.5	3500	5300
60	61812 EE 61812 ZZY	78	10	11.8	11.1	4700	7700
	6012 EE 6012 ZZ	95	18	29.5	23.2	4300	6400
	6212 EE 6212 ZZ	110	22	52	36	3600	5500
	6312 EE 6312 ZZ	130	31	82	52	3200	4800

* These are the speed limits according to the SNR concept (see pages 85 to 87).



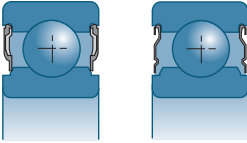

■ Sealed and shielded bearing (continued)

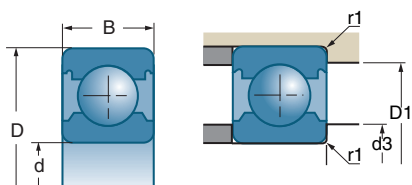

References		d3 min	D1 max	r1 max	kg
INDEX 20					
61807 2RS 61807 ZZ		37.2	44.8	0.30	0.0290
61907 2RS		38.6	51.4	0.60	0.0740
6007 EE 6007 ZZ		40.0	57.0	1.00	0.1330
63007 EE		40.0	57.0	1.00	0.2140
6207 EE 6207 ZZ		42.0	65.0	1.10	0.2850
62207 EE		42.0	65.0	1.10	0.3750
6307 EE 6307 ZZ		44.0	71.0	1.50	0.4460
62307 EE		44.0	71.0	1.50	0.6580
61808 2RS 61808 ZZ		42.2	49.8	0.30	0.0350
6008 EE 6008 ZZ		45.0	63.0	1.00	0.1920
63008 EE		45.0	63.0	1.00	0.2620
6208 EE 6208 ZZ		47.0	73.0	1.10	0.3670
62208 EE		47.0	73.0	1.10	0.4600
6308 EE 6308 ZZ		49.0	81.0	1.50	0.6120
62308 EE		49.0	81.0	1.50	0.8740
61809 EE 61809 ZZY		47.6	55.4	0.30	0.0390
6009 EE 6009 ZZ		50.0	70.0	1.00	0.2480
6209 EE 6209 ZZ		52.0	78.0	1.10	0.4040
62209 EE		52.0	78.0	1.10	0.4810
6309 EE 6309 ZZ		54.0	91.0	1.50	0.8250
61810 EE 61810 ZZY		52.6	62.4	0.30	0.0520
6010 EE 6010 ZZ		55.0	75.0	1.00	0.2654
6210 EE 6210 ZZ		57.0	83.0	1.10	0.4530
62210 EE		57.0	83.0	1.10	0.5140
6310 EE 6310 ZZ		61.0	99.0	2.00	1.0700
61811 EE 61811 ZZY		57.6	69.4	0.30	0.0840
6011 EE 6011 ZZ		61.0	84.0	1.10	0.3880
6211 EE 6211 ZZ		64.0	91.0	1.50	0.6030
6311 EE 6311 ZZ		66.0	109.0	2.00	1.3800
61812 EE 61812 ZZY		62.6	75.4	0.30	0.1050
6012 EE 6012 ZZ		66.0	89.0	1.10	0.4114
6212 EE 6212 ZZ		69.0	101.0	1.50	0.7850
6312 EE 6312 ZZ		73.0	117.0	2.10	1.7200

Single-row radial ball bearings (continued)

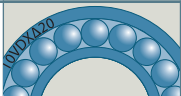



d		D	B				
				10°N	10°N	rpm EE/2RS*	rpm ZZ*
mm	References	mm	mm				
65	61813 EE 61813 ZZ	85	10	12.3	12	4400	7100
	6013 EE 6013 ZZ	100	18	30.5	25	4000	6100
	6213 EE 6213 ZZ	120	23	57	40	3400	5100
	6313 EE 6313 ZZ	140	33	93	60	3000	4500
70	61814 EE 61814 ZZ	90	10	12.4	12.4	4100	6700
	6014 EE 6014 ZZ	110	20	38	31	3700	5500
	6214 EE 6214 ZZ	125	24	62	44	3200	4900
	6314 EE 6314 ZZ	150	35	104	68	2800	4200
75	61815 EE 61815 ZZ	95	10	12.9	13.3	3800	6300
	6015 EE 6015 ZZ	115	20	39.5	33.5	3500	5200
	6215 EE 6215 ZZ	130	25	67	48	3100	4600
	6315 EE 6315 ZZ	160	37	113	77	2600	3900
80	61816 EE 61816 ZZ	100	10	13	13.8	3600	6000
	6016 EE 6016 ZZ	125	22	47.5	39.5	3200	4800
	6216 EE 6216 ZZ	140	26	73	53	2900	4300
	6316 EE 6316 ZZ	170	39	123	86	2400	3700
85	61817 EE 61817 ZZ	110	13	19.3	19.8	3300	5500
	6017 EE 6017 ZZ	130	22	49.5	43	3100	4600
	6217 EE 6217 ZZ	150	28	84	62	2700	4000
	6317 EE 6317 ZZ	180	41	133	97	2300	3500
90	61818 EE 61818 ZZ	115	13	19.5	20.5	3200	5200
	6018 EE 6018 ZZ	140	24	58	49.5	2800	4300
	6218 EE 6218 ZZ	160	30	96	71	2500	3800
	6318 EE 6318 ZZ	190	43	143	107	2200	3300
95	61819 EE 61819 ZZ	120	13	19.8	21.3	3000	5000
	6019 EE 6019 ZZ	145	24	60	54	2700	4000
	6219 EE 6219 ZZ	170	32	109	82	2400	3600
	6319 EE 6319 ZZ	170	32	109	82		3100
100	61820 EE 61820 ZZ	125	13	20.1	22	2900	4800
	6020 EE 6020 ZZ	150	24	60	54	2600	4000
	6220 EE 6220 ZZ	180	34	122	93	2300	3400
	6320 EE 6320 ZZ	180	34	122	93		2900

* These are the speed limits according to the SNR concept (see pages 85 to 87).



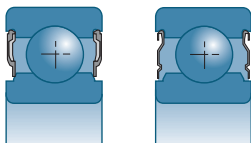

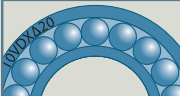
■ Sealed and shielded bearing (continued)

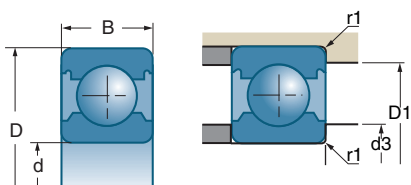

	d3	D1	r1	
	min	max	max	
References	mm	mm	mm	kg
61813 EE 61813 ZZ	69.2	80.8	0.60	0.1300
6013 EE 6013 ZZ	71.0	94.0	1.10	0.4540
6213 EE 6213 ZZ	74.0	111.0	1.50	0.9910
6313 EE 6313 ZZ	78.0	127.0	2.10	2.0770
61814 EE 61814 ZZ	74.2	85.8	0.60	0.1400
6014 EE 6014 ZZ	76.0	104.0	1.10	0.6100
6214 EE 6214 ZZ	79.0	116.0	1.50	1.0000
6314 EE 6314 ZZ	83.0	137.0	2.10	2.5660
61815 EE 61815 ZZ	79.2	90.8	0.60	0.1500
6015 EE 6015 ZZ	81.0	109.0	1.10	0.6400
6215 EE 6215 ZZ	84.0	121.0	1.50	1.1900
6315 EE 6315 ZZ	88.0	147.0	2.10	3.1200
61816 EE 61816 ZZ	84.2	95.2	0.60	0.1550
6016 EE 6016 ZZ	86.0	119.0	1.10	0.8700
6216 EE 6216 ZZ	91.0	129.0	2.00	1.4200
6316 EE 6316 ZZ	93.0	157.0	2.10	3.7000
61817 EE 61817 ZZ	90.4	104.6	1.00	0.2700
6017 EE 6017 ZZ	91.0	124.0	1.10	0.9000
6217 EE 6217 ZZ	96.0	139.0	2.00	1.8500
6317 EE 6317 ZZ	99.0	166.0	3.00	4.2100
61818 EE 61818 ZZ	95.4	109.6	1.00	0.2800
6018 EE 6018 ZZ	98.0	132.0	1.50	1.1750
6218 EE 6218 ZZ	101.0	149.0	2.00	2.2500
6318 EE 6318 ZZ	104.0	176.0	3.00	4.9730
61819 EE 61819 ZZ	100.4	114.6	1.00	0.2950
6019 EE 6019 ZZ	103.0	137.0	1.50	1.2200
6219 EE 6219 ZZ	108.0	157.0	2.10	2.8000
6319 EE 6319 ZZ	108.0	157.0	2.10	2.6700
61820 EE 61820 ZZ	105.4	119.6	1.00	0.3100
6020 EE 6020 ZZ	108.0	142.0	1.50	1.2600
6220 EE 6220 ZZ	113.0	167.0	2.10	3.1200
6320 EE 6320 ZZ	113.0	167.0	2.10	3.1870

Single-row radial ball bearings (continued)

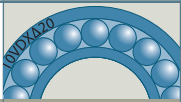



d		D	B				
				10°N	10°N	rpm EE/2RS*	rpm ZZ*
mm	References	mm	mm				
105	61821 EE 61821 ZZY 6021 EE	130 160	13 26	20.8 72	23.6 66	2800 2400	4600
110	61822 EE 61822 ZZY 6022 EE	140 170	16 28	28 82	30.5 73	2600 2300	4300
120	61824 EE 61824 ZZY 6024 EE	150 180	16 28	29 85	33 79	2400 2200	4000
130	61826 2RS 61826 ZZ	165	18	38	43	2000	3600
140	61828 2RS 61828 ZZ 6028 EE	175 210	18 33	39 109	46 107	1850 2800	3400
160	6032 EE	240	38	137	135	2500	

* These are the speed limits according to the SNR concept (see pages 85 to 87).

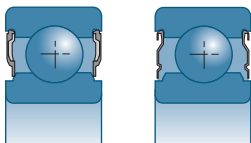

■ Sealed and shielded bearing (continued)

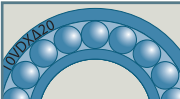

	d3 min	D1 max	r1 max	
References	mm	mm	mm	kg
61821 EE 61821 ZZY 6021 EE	110.4 114.0	124.6 151.0	1.00 2.00	0.3300 1.5900
61822 EE 61822 ZZY 6022 EE	115.4 119.0	134.6 161.0	1.00 2.00	0.5000 1.4900
61824 EE 61824 ZZY 6024 EE	125.4 129.0	144.6 171.0	1.00 2.00	0.5500 2.1400
61826 2RS 61826 2Z	137.6	157.4	1.10	0.7800
61828 2RS 61828 2Z 6028 EE	147.6 149.0	167.4 201.0	1.10 2.00	0.8300 3.6500
6032 EE	170.0	230.0	2.10	6.3000

Single-row radial ball bearings (continued)

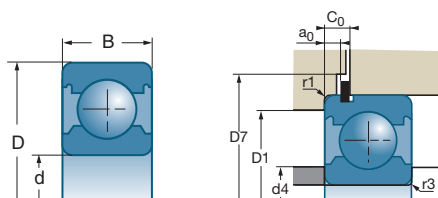

d			D	B					a0 min	a0 max
	mm	References			mm	mm	10 ³ N	10 ³ N		
10	6200 N	6200 NR	30	9	6	2.65	23000	27000	1.9	2.06
12	6201 N	6201 NR	32	10	6.9	3.1	21000	25000	1.9	2.06
15	6002 N	6002 NR	32	9	5.6	2.85	21000	26000	1.9	2.06
	6202 N	6202 NR	35	11	7.7	3.75	19000	22000	1.9	2.06
17	6003 N	6003 NR	35	10	6	3.25	19000	23000	1.9	2.06
	6203 N	6203 NR	40	12	9.5	4.75	16000	19000	1.9	2.06
20	6004 N	6004 NR	42	12	9.4	5	16000	20000	1.9	2.06
	6204 N	6204 NR	47	14	12.8	6.6	14000	16000	2.31	2.46
	6304 N	6304 NR	52	15	15.9	7.9	12000	15000	2.31	2.46
25	6005 N	6005 NR	47	12	10.1	5.8	14000	18000	1.9	2.06
	6205 N	6205 NR	52	15	14	7.9	12000	14000	2.31	2.46
	6305 N	6305 NR	62	17	23.6	12.1	10000	13000	3.07	3.28
30	6006 N	6006 NR	55	13	13.2	8.3	12000	15000	1.88	2.08
	6206 N	6206 NR	62	16	19.5	11.3	10000	12000	3.07	3.28
	6306 N	6306 NR	72	19	28	15.8	8900	10000	3.07	3.28
35	6007 N	6007 NR	62	14	16	10.3	10000	12000	1.88	2.08
	6207 N	6207 NR	72	17	25.5	15.3	8700	10000	3.07	3.28
	6307 N	6307 NR	80	21	33.5	19.2	8000	9800	3.07	3.28
40	6008 N	6008 NR	68	15	16.8	11.5	9200	11000	2.29	2.49
	6208 N	6208 NR	80	18	29	17.9	7800	9100	3.07	3.28
	6308 N	6308 NR	90	23	40.5	23.9	7200	8800	3.07	3.28
	6408 N	6408 NR	110	27	63	36.5	6200	7600	3.07	3.28
45	6009 N	6009 NR	75	16	21	15.2	8300	10000	2.29	2.49
	6209 N	6209 NR	85	19	32.5	20.5	7300	8800	3.07	3.28
	6309 N	6309 NR	100	25	53	31.5	6400	7800	3.07	3.28
	6409 N	6409 NR	120	29	77	45	5600	6900	3.86	4.06
50	6010 N	6010 NR	80	16	21.8	16.6	7600	9400	2.29	2.49
	6210 N	6210 NR	90	20	35	23.2	6900	8200	3.07	3.28
	6310 N	6310 NR	110	27	62	38	5800	7100	3.07	3.28

* These are the speed limits according to the SNR concept (see pages 85 to 87).



■ Bearing with groove or groove and snap ring

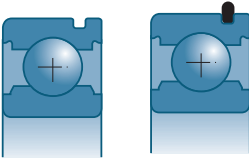

References		c0 min	c0 max	d4 min	D1 max	D7 min	r3 max	r1 max	snap ring	kg
6200 N 6200 NR	2.92 3.18	14.0 26.0	36	0.6 0.6	R 30	0.033				
6201 N 6201 NR	2.92 3.18	16.0 28.0	38	0.6 0.6	R 32	0.039				
6002 N 6002 NR	2.92 3.18	17.0 30.0	38	0.3 0.3	R 32	0.030				
6202 N 6202 NR	2.92 3.18	19.0 31.2	41	0.6 0.6	R 35	0.045				
6003 N 6003 NR	2.92 3.18	19.0 33.0	41	0.3 0.3	R 35	0.039				
6203 N 6203 NR	2.92 3.18	21.0 36.0	46	0.6 0.6	R 40	0.065				
6004 N 6004 NR	2.92 3.18	24.0 38.0	47.5	0.6 0.5	R 42	0.068				
6204 N 6204 NR	3.33 3.58	26.0 41.3	54	1 0.6	R 47	0.106				
6304 N 6304 NR	3.33 3.58	27.0 45.0	59	1.1 0.6	R 52	0.145				
6005 N 6005 NR	2.92 3.18	29.0 43.0	54	0.6 0.5	R 47	0.080				
6205 N 6205 NR	3.33 3.58	31.0 46.5	59	1 0.5	R 52	0.126				
6305 N 6305 NR	4.67 4.98	32.0 55.0	69	1.1 0.6	R 62	0.225				
6006 N 6006 NR	2.9 3.2	35.0 50.0	62	1 0.5	R 55	0.116				
6206 N 6206 NR	4.67 4.98	36.0 56.0	69	1 0.5	R 62	0.199				
6306 N 6306 NR	4.67 4.98	37.0 65.0	80	1.1 0.6	R 72	0.346				
6007 N 6007 NR	3.48 3.78	40.0 57.0	69	1 0.5	R 62	0.153				
6207 N 6207 NR	4.67 4.98	42.0 65.0	80	1.1 0.5	R 72	0.285				
6307 N 6307 NR	4.67 4.98	44.0 71.0	88	1.5 0.5	R 80	0.446				
6008 N 6008 NR	3.89 4.19	45.0 63.0	76	1 0.6	R 68	0.192				
6208 N 6208 NR	4.67 4.98	47.0 73.0	88	1.1 0.5	R 80	0.373				
6308 N 6308 NR	5.43 5.74	49.0 81.0	97.5	1.5 0.6	R 90	0.625				
6408 N 6408 NR	5.43 5.74	52.0 98.0	118	2 0.6	R 110	1.214				
6009 N 6009 NR	3.89 4.19	50.0 70.0	83	1 0.6	R 75	0.244				
6209 N 6209 NR	4.67 4.98	52.0 78.0	93	1.1 0.5	R 85	0.404				
6309 N 6309 NR	5.43 5.74	54.0 91.0	108	1.5 0.5	R 100	0.825				
6409 N 6409 NR	6.58 6.88	57.0 108.0	131	2 0.6	R 120	1.513				
6010 N 6010 NR	3.89 4.19	55.0 75.0	88	1 0.5	R 80	0.267				
6210 N 6210 NR	5.43 5.74	57.0 83.0	97.5	1.1 0.6	R 90	0.439				
6310 N 6310 NR	5.43 5.74	61.0 99.0	118	2 0.6	R 110	1.070				

Single-row radial ball bearings (continued)

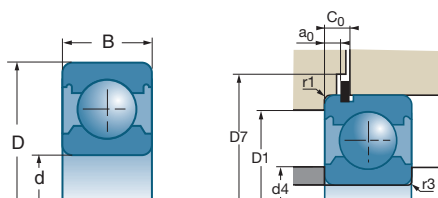

d			D	B					a0 min	a0 max
	mm	References			mm	mm	10 ³ N	10 ³ N		
55	6011 N	6011 NR	90	18	28.5	21.3	6800	8500	2.67	2.87
	6211 N	6211 NR	100	21	43.5	29	6200	7400	3.07	3.28
	6311 N	6311 NR	120	29	71	44.5	5200	6500	3.86	4.06
	6411 N	6411 NR	140	33	100	62	4800	5800	4.65	4.9
60	6212 N	6212 NR	110	22	52	36	5600	6800	3.07	3.28
	6312 N	6312 NR	130	31	82	52	4800	5900	3.86	4.06
65	6013 N	6013 NR	100	18	30.5	25	6100	7500	2.67	2.87
	6213 N	6213 NR	120	23	57	40	5100	6200	3.86	4.06
	6313 N	6313 NR	140	33	93	60	4500	5600	4.65	4.9
70	6014 N	6014 NR	110	20	38	31	5500	6800	2.67	2.87
85	6017 N	6017 NR	130	22	49.5	43	4700	5800	2.67	2.87
	6217 N	6217 NR	150	28	83	64	4100	4900	4.65	4.9
90	6018 N	6018 NR	140	24	58	49.5	4300	5300	3.45	3.71
100	6020 N	6020 NR	150	24	60	54	4000	4900	3.45	3.71
120	6024 N	6024 NR	180	28	85	79	3300	4100	3.45	3.71

* These are the speed limits according to the SNR concept (see pages 85 to 87).



■ Bearing with groove or groove and snap ring (*continued*)

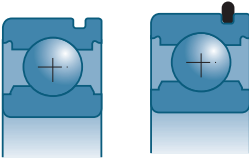

References		c0 min	c0 max	d4 min	D1 max	D7 min	r3 max	r1 max	snap ring	kg
6011 N	6011 NR	5.03	5.33	61.0	84.0	97.5	1.1	0.6	R 90	0.388
6211 N	6211 NR	5.43	5.74	64.0	91.0	107.5	1.5	0.6	R 100	0.598
6311 N	6311 NR	6.58	6.88	66.0	109.0	131	2	0.5	R 120	1.380
6411 N	6411 NR	7.37	7.72	69.0	126.0	151	2.1	0.6	R 140	2.283
6212 N	6212 NR	5.43	5.74	69.0	101.0	118	1.5	0.6	R 110	0.763
6312 N	6312 NR	6.58	6.88	73.0	117.0	141	2.1	0.6	R 130	1.685
6013 N	6013 NR	5.03	5.33	71.0	94.0	107.5	1.1	0.6	R 100	0.432
6213 N	6213 NR	6.58	6.88	74.0	111.0	131	1.5	0.5	R 120	0.990
6313 N	6313 NR	7.37	7.72	78.0	127.0	151	2.1	0.6	R 140	2.060
6014 N	6014 NR	5.03	5.33	76.0	104.0	117.5	1.1	0.5	R 110	0.610
6017 N	6017 NR	5.39	5.69	91.0	124.0	141	1.1	0.6	R 130	0.879
6217 N	6217 NR	7.37	7.72	96.0	139.0	161	2	0.6	R 150	1.776
6018 N	6018 NR	6.17	6.53	98.0	132.0	151	1.5	0.6	R 140	1.175
6020 N	6020 NR	6.17	6.53	108.0	142.0	161	1.5	0.6	R 150	1.260
6024 N	6024 NR	6.45	6.81	129.0	171.0	194	2	0.6	R 180	2.100

Stainless Steel ball bearings

Definition and capabilities

This bearing family combines high corrosion resistance and a load capacity which matches that of standard steel bearings: it is the ideal solution for machines operated in corrosive environments such as:

- Farming industry, pharmaceutical and chemical sector
- Others, such as paper mills, engines, pumps, naval application, etc.

Series

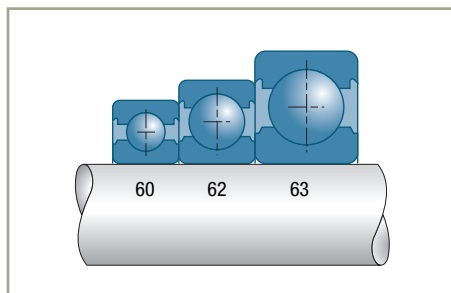



Variations

All SNR single-row ball bearings made of stainless steel display the prefix S (referring to the steel used) and the suffix 2RS (indicative of standard, dual seal version).



There are two variations for these series, depending on whether the bearings are lubricated with standard grease or with a food-compatible grease (suffix D136).

Suffixes

2RS	Two-side sealing
D136	Food grade grease

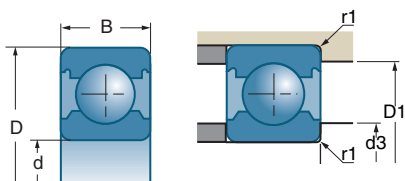
Stainless Steel ball bearings (continued)

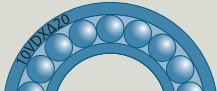

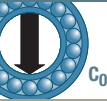
d		D	B			
mm	References	mm	mm	rpm*	10°N	10°N
10	S6000 2RS S6000 2RSD136	26	8	18000	4.55	1.96
	S6200 2RS S6200 2RSD136	30	9	15000	5.10	2.39
	S6300 2RS S6300 2RSD136	35	11	13000	8.10	3.45
12	S6001 2RS S6001 2RSD136	28	8	16000	5.10	2.39
	S6201 2RS S6201 2RSD136	32	10	14000	6.10	2.80
	S6301 2RS S6301 2RSD136	37	12	12000	9.70	4.20
15	S6002 2RS S6002 2RSD136	32	9	14000	5.60	2.85
	S6202 2RS S6202 2RSD136	35	11	12000	7.60	3.70
	S6302 2RS S6302 2RSD136	42	13	10000	11.40	5.40
17	S6003 2RS S6003 2RSD136	35	10	12000	6.00	3.25
	S6203 2RS S6203 2RSD136	40	12	11000	9.60	4.80
	S6303 2RS S6303 2RSD136	47	14	9300	13.60	6.60
20	S6004 2RS S6004 2RSD136	42	12	10000	9.40	5.10
	S6204 2RS S6204 2RSD136	47	14	9200	12.80	6.70
	S6304 2RS S6304 2RSD136	52	15	8600	15.90	7.90
25	S6005 2RS S6005 2RSD136	47	12	9200	10.10	5.90
	S6205 2RS S6205 2RSD136	52	15	8200	14.00	7.90
	S6305 2RS S6305 2RSD136	62	17	6900	20.60	11.20
30	S6006 2RS S6006 2RSD136	55	13	7800	13.20	8.30
	S6206 2RS S6206 2RSD136	62	16	6800	19.50	11.30
35	S6007 2RS S6007 2RSD136	62	14	6800	16.00	10.30
	S6207 2RS S6207 2RSD136	72	17	5800	25.50	15.40
40	S6008 2RS S6008 2RSD136	68	15	6100	16.80	11.50
	S6208 2RS S6208 2RSD136	80	18	5300	29.00	17.90

* These are the speed limits according to the SNR concept (see pages 85 to 87).



Characteristics

■ Stainless steel ball bearings

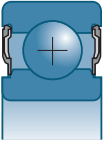

		d3 min	D1 max	r1 max	
References		mm	mm	mm	kg
S6000 2RS	S6000 2RSD136	12.0	24.0	0.3	0.019
S6200 2RS	S6200 2RSD136	14.0	26.0	0.6	0.032
S6300 2RS	S6300 2RSD136	14.0	31.0	0.6	0.053
S6001 2RS	S6001 2RSD136	14.0	26.0	0.3	0.022
S6201 2RS	S6201 2RSD136	16.0	28.0	0.6	0.032
S6301 2RS	S6301 2RSD136	17.9	31.5	1	0.060
S6002 2RS	S6002 2RSD136	17.0	30.0	0.3	0.030
S6202 2RS	S6202 2RSD136	19.0	31.2	0.6	0.045
S6302 2RS	S6302 2RSD136	21.0	36.3	1	0.082
S6003 2RS	S6003 2RSD136	19.0	33.0	0.3	0.039
S6203 2RS	S6203 2RSD136	21.0	36.0	0.6	0.065
S6303 2RS	S6303 2RSD136	23.0	41.0	1	0.115
S6004 2RS	S6004 2RSD136	24.0	38.0	0.6	0.069
S6204 2RS	S6204 2RSD136	26.0	41.3	1	0.106
S6304 2RS	S6304 2RSD136	27.0	45.0	1.1	0.144
S6005 2RS	S6005 2RSD136	29.0	43.0	0.6	0.080
S6205 2RS	S6205 2RSD136	31.0	46.5	1	0.128
S6305 2RS	S6305 2RSD136	32.0	55.0	1.1	0.232
S6006 2RS	S6006 2RSD136	35.0	50.0	1	0.116
S6206 2RS	S6206 2RSD136	36.0	56.0	1	0.199
S6007 2RS	S6007 2RSD136	40.0	57.0	1	0.155
S6207 2RS	S6207 2RSD136	42.0	65.0	1.1	0.275
S6008 2RS	S6008 2RSD136	45.0	63.0	1	0.191
S6208 2RS	S6208 2RSD136	47.0	73.0	1.1	0.366

Bearing for special applications

Definitions and capabilities

Amongst multiple industrial applications, in some tangible cases, bearings must operate in a particular environment, as is the case with kiln car wheels. However, certain conditions are often encountered, such as high or very high temperatures, low temperatures or high speeds. SNR is aware of the difficulty, for users, to procure single-row ball bearings capable of such conditions, and therefore created the **TOPLINE Range**. As standard, this range offers bearing designs which were previously considered as specific, therefore introducing significant delivery-time and costs-savings advantages.

Series

- **FT series:** for operation up to 150° C (300°F) peak (and up to 500 000 N.Dm) 6000, 6200, 6300 series
 - So-called « high temperature » (-40°C/ -40°F to +200°C/ +400°F) seals made of Viton for the FT 150 series, providing excellent resistance to chemical agents and permitting high speed rotation, highly effective against outside contamination.
 - Pressed-steel shields for the FT150 ZZ series, no bearing operating speed limitation.
 - J30: (C3) increased clearance (Category 3) to compensate for variations in temperatures.
 - Grease specifically tested and selected for high temperatures.
 - Pressed-steel cage, no limitations for bearing operating temperature.

- **HT series:** for operation up to 200° C (400°F) peak (and up to 150 000 N.Dm) 6200, 6300 series
 - Viton seals for the HT200 series (- 40° C to + 200° C).
 - Pressed-steel shields for the HT200 ZZ series.
 - Special heat treat providing metallurgical stability for operating temperatures up to + 200°C (400°F).
 - J40 (C4): increased internal clearance (Category 4) to compensate for variations in temperatures.
 - Pressed-steel cage.
 - Grease specifically tested and selected for very high temperatures.

- **LT series:** for operation up to -60° C (-75°F) (and up to 500 000 N.Dm) 6000, 6200 series
 - Nitrile rubber seal (- 40° C/ -40°F up to + 110° C/ +230°F) for the LT series.
 - Pressed-steel shields for the LT ZZ series.
 - Pressed-steel cage.
 - J30 (C3): increased internal clearance (Category3) to compensate for variations in temperature.
 - Grease specifically tested and selected for low temperatures and damp atmosphere.



- **HV series:** for operation up to 700 000 N.Dm 6000, 6200 series
 - High precision bearing that meet DIN P6 or ISO 6 standards for high accuracy.
 - High precision balls: grade 10. Grade 10 is the 3rd most stringent grade in the classification of rolling elements (in the order: grade 3, 5, 10, 16, etc.). Very high surface finish quality.
 - Improved internal geometry with tight tolerances.
 - Glass-fiber reinforced polyamide cage provides accurate guidance of rolling elements for improved capabilities at high speed.
 - Pressed-steel shields.
 - Grease specifically tested and selected for very high speeds and low torque.
- **F600 series:** for operation up to 350° C (660°F) and below 50 rpm. 6000, 6200, 6300 series

- **Large radial clearance**

This clearance is sufficient to compensate for differential thermal expansion between the inner and outer rings of the bearing and for the expansion of surrounding parts.

- **Heat treatment** with stabilization tempering. Beyond 110-120° C (230°F -250°F), steel undergoes a structural change resulting in a decrease of its specific volume. To limit this phenomenon, SNR F600 bearings are subject to a special high-temperature tempering.

- **Pressed steel cage**

- **Recessed markings on both rings:** this marking process allows maintaining the proper identification of any bearings at all times regardless of operating conditions.

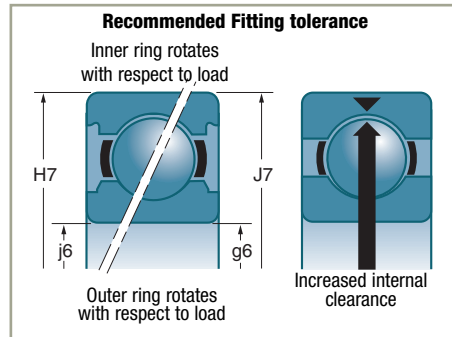

Variations

- **FT, HT and LT:** the basic design for each one of these families is the dual sealing. A dual protected variation is also available: ZZ.
- **F600:** as basic design is open and with surface treatment by phosphating and molybdenum disulfide deposit, variations are available with 1 or 2 shields along with a high temperature lubrication paste.

Tolerances and clearances

- **FT, LT:** manufactured in normal tolerance class and increased clearance class C3.
- **HT:** manufactured in normal tolerance class and increased clearance class C4.
- **HV:** manufactured with high precision balls and in tolerance class that meets ISO 6 standards for high accuracy. Clearance class C3.
- **F600:** manufactured in special clearance class, up to C5 defined by the standards.

Bearing for special applications (continued)

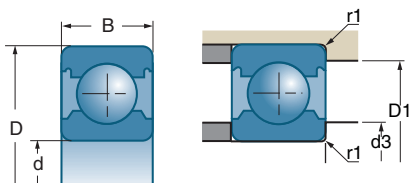

d			D	B				
					rpm EE*	rpm ZZ*	10 ³ N	10 ³ N
mm	References		mm	mm				
8	608 FT150		22	7	22000		3.3	1.36
10	6000 FT150	6000 FT150ZZ	26	8	18000	27000	4.6	1.97
		6000 HVZZ	26	8		38800	4.6	1.97
	6000 LT	6000 LTZZ	26	8	19000	28000	4.6	1.97
		6200 FT150ZZ	30	9		24000	6	2.65
	6200 LT	6200 LTZZ	30	9	16000	23000	6	2.65
	6300 FT150ZZ		35	11		22000	8.1	3.45
12	6001 FT150	6001 FT150ZZ	28	8	16000	25000	5.1	2.37
		6001 HVZZ	28	8		35000	5.1	2.37
	6001 LT	6001 LTZZ	28	8	17000	25000	5.1	2.37
	6201 FT150	6201 FT150ZZ	32	10	15000	22000	6.9	3.1
		6201 HT200ZZ	32	10		6800	6.9	3.1
		6201 HVZZ	32	10		31800	6.9	3.1
	6201 LT	6201 LTZZ	32	10	15000	22000	6.9	3.1
		6301 FT150ZZ		37	12		20000	9.7
15	6002 FT150	6002 FT150ZZ	32	9	14000	21000	5.6	2.85
		6002 HVZZ	32	9		29700	5.6	2.85
	6002 LT	6002 LTZZ	32	9	14000	21000	5.6	2.85
	6202 FT150	6202 FT150ZZ	35	11	13000	19000	7.7	3.75
		6202 HT200ZZ	35	11		5900	7.7	3.75
		6202 HVZZ	35	11		28000	7.7	3.75
	6202 LT	6202 LTZZ	35	11	13000	19000	7.7	3.75
		6302 FT150ZZ		42	13		17000	11.3
17	6003 FT150	6003 FT150ZZ	35	10	12000	19000	6	3.25
		6003 HVZZ	35	10		26900	6	3.25
	6003 LT	6003 LTZZ	35	10	13000	19000	6	3.25
	6203 FT150	6203 FT150ZZ	40	12	11000	17000	9.5	4.75
		6203 HT200ZZ	40	12		5200	9.5	4.75
		6203 HVZZ	40	12		24500	9.5	4.75
	6203 LT	6203 LTZZ	40	12	11000	17000	9.5	4.75
	6303 FT150	6303 FT150ZZ	47	14	10000	15000	13.6	6.6

* These are the speed limits according to the SNR concept (see pages 85 to 87).



Characteristics



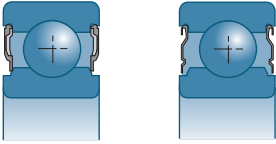

■ TOPLINE bearing for special applications

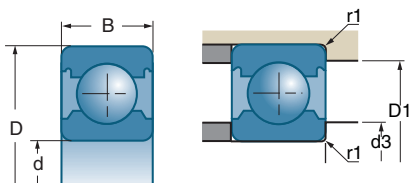

		d3 min	D1 max	r1 max	
References		mm	mm	mm	kg
608 FT150		10.0	20.0	0.3	0.012
6000 FT150	6000 FT150ZZ	12.0	24.0	0.3	0.019
	6000 HVZZ	12.0	24.0	0.3	0.019
6000 LT	6000 LTZZ	12.0	24.0	0.3	0.019
	6200 FT150ZZ	14.0	26.0	0.6	0.033
6200 LT	6200 LTZZ	14.0	26.0	0.6	0.033
	6300 FT150ZZ	14.0	31.0	0.6	0.053
6001 FT150	6001 FT150ZZ	14.0	26.0	0.3	0.022
	6001 HVZZ	14.0	26.0	0.3	0.022
6001 LT	6001 LTZZ	14.0	26.0	0.3	0.022
6201 FT150	6201 FT150ZZ	16.0	28.0	0.6	0.037
	6201 HT200ZZ	16.0	28.0	0.6	0.035
	6201 HVZZ	16.0	28.0	0.6	0.037
6201 LT	6201 LTZZ	16.0	28.0	0.6	0.037
	6301 FT150ZZ	17.9	31.5	1	0.060
6002 FT150	6002 FT150ZZ	17.0	30.0	0.3	0.030
	6002 HVZZ	17.0	30.0	0.3	0.030
6002 LT	6002 LTZZ	17.0	30.0	0.3	0.030
6202 FT150	6202 FT150ZZ	19.0	31.2	0.6	0.046
	6202 HT200ZZ	19.0	31.2	0.6	0.044
	6202 HVZZ	19.0	31.2	0.6	0.045
6202 LT	6202 LTZZ	19.0	31.2	0.6	0.045
	6302 FT150ZZ	21.0	36.3	1	0.083
6003 FT150	6003 FT150ZZ	19.0	33.0	0.3	0.039
	6003 HVZZ	19.0	33.0	0.3	0.039
6003 LT	6003 LTZZ	19.0	33.0	0.3	0.039
6203 FT150	6203 FT150ZZ	21.0	36.0	0.6	0.068
	6203 HT200ZZ	21.0	36.0	0.6	0.065
	6203 HVZZ	21.0	36.0	0.6	0.065
6203 LT	6203 LTZZ	21.0	36.0	0.6	0.065
6303 FT150	6303 FT150ZZ	23.0	41.0	1	0.113

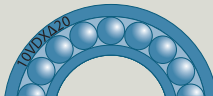
Bearing for special applications (continued)





d			D	B						
					rpm EE*	rpm ZZ*	10°N	10°N	10°N	10°N
mm	References		mm	mm						
20	6004 FT150	6004 FT150ZZ	42	12	10000	16000	9.4	5		
	6004 HT200	6004 HVZZ	42	12	4800	22500	9.4	5		
	6004 LT	6004 LTZZ	42	12	10000	16000	9.4	5		
	6204 FT150	6204 FT150ZZ	47	14	9900	14000	12.8	6.6		
	6204 HT200	6204 HT200ZZ	47	14	4400	4400	12.8	6.6		
		6204 HVZZ	47	14		20800	12.8	6.6		
	6204 LT	6204 LTZZ	47	14	9300	14000	12.8	6.6		
	6304 FT150	6304 FT150ZZ	52	15	9200	13000	15.9	7.9		
	6304 HT200	6304 HT200ZZ	52	15	4100	4100	15.9	7.9		
		6304 LTZZ	52	15		12000	15.9	7.9		
25	6005 FT150	6005 FT150ZZ	47	12	9300	14000	10.1	5.8		
		6005 HVZZ	47	12		19400	10.1	5.8		
	6005 LT	6005 LTZZ	47	12	9300	14000	10.1	5.8		
	6205 FT150	6205 FT150ZZ	52	15	8500	12000	14	7.9		
	6205 HT200	6205 HT200ZZ	52	15	3800	3800	14	7.9		
		6205 HVZZ	52	15		18100	14	7.9		
	6205 LT	6205 LTZZ	52	15	8200	12000	14	7.9		
	6305 FT150	6305 FT150ZZ	62	17	7600	11000	23.6	12.1		
	6305 HT200	6305 HT200ZZ	62	17	3400	3400	23.6	12.1		
	30	6006 FT150	6006 FT150ZZ	55	13	7800	11000	13.2	8.3	
		6006 HVZZ	55	13		16400	13.2	8.3		
6006 LT		6006 LTZZ	55	13	7800	12000	13.2	8.3		
6206 FT150		6206 FT150ZZ	62	16	7200	10000	19.5	11.3		
6206 HT200		6206 HT200ZZ	62	16	3200	3200	19.5	11.3		
		6206 HVZZ	62	16		15200	19.5	11.3		
6206 LT		6206 LTZZ	62	16	7000	10000	19.5	11.3		
6306 FT150		6306 FT150ZZ	72	19	6400	9600	28	15.8		
6306 HT200		6306 HT200ZZ	72	19	2900	2900	28	15.8		
35		6007 FT150	6007 FT150ZZ	62	14	6800	10000	16	10.3	
		6007 HVZZ	62	14		16400	16	10.3		
		6007 LTZZ	62	14		10000	16	10.3		
	6207 FT150	6207 FT150ZZ	72	17	6200	9300	25.5	15.3		
	6207 HT200	6207 HT200ZZ	72	17	2800	2800	25.5	15.3		
		6207 HVZZ	72	17		13000	25.5	15.3		
	6307 FT150	6307 FT150ZZ	80	21	5700	8600	33.5	19.2		
	6307 HT200	6307 HT200ZZ	80	21	5300	2600	33.5	19.1		

* These are the speed limits according to the SNR concept (see pages 85 to 87).



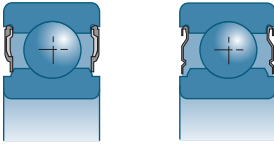



■ TOPLINE bearing for special applications (continued)

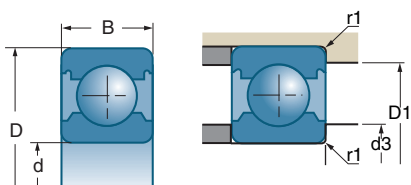

References		d3 min	D1 max	r1 max	
		mm	mm	mm	kg
6004 FT150	6004 FT150ZZ	24.0	38.0	0.6	0.068
6004 HT200	6004 HVZZ	24.0	38.0	0.6	0.070
6004 LT	6004 LTZZ	24.0	38.0	0.6	0.068
6204 FT150	6204 FT150ZZ	26.0	41.3	1	0.107
6204 HT200	6204 HT200ZZ	26.0	41.3	1	0.107
	6204 HVZZ	26.0	41.3	1	0.107
6204 LT	6204 LTZZ	26.0	41.3	1	0.107
6304 FT150	6304 FT150ZZ	27.0	45.0	1.1	0.147
6304 HT200	6304 HT200ZZ	27.0	45.0	1.1	0.147
	6304 LTZZ	27.0	45.0	1.1	0.135
6005 FT150	6005 FT150ZZ	29.0	43.0	0.6	0.077
	6005 HVZZ	29.0	43.0	0.6	0.077
6005 LT	6005 LTZZ	29.0	43.0	0.6	0.077
6205 FT150	6205 FT150ZZ	31.0	47.0	1	0.128
6205 HT200	6205 HT200ZZ	31.0	47.0	1	0.128
	6205 HVZZ	31.0	47.0	1	0.128
6205 LT	6205 LTZZ	31.0	47.0	1	0.128
6305 FT150	6305 FT150ZZ	32.0	55.0	1.1	0.225
6305 HT200	6305 HT200ZZ	32.0	55.0	1.1	0.225
6006 FT150	6006 FT150ZZ	35.0	50.0	1	0.116
	6006 HVZZ	35.0	50.0	1	0.116
6006 LT	6006 LTZZ	35.0	50.0	1	0.116
6206 FT150	6206 FT150ZZ	36.0	56.0	1	0.199
6206 HT200	6206 HT200ZZ	36.0	56.0	1	0.199
	6206 HVZZ	36.0	56.0	1	0.199
6206 LT	6206 LTZZ	36.0	56.0	1	0.199
6306 FT150	6306 FT150ZZ	37.0	65.0	1.1	0.346
6306 HT200	6306 HT200ZZ	37.0	65.0	1.1	0.346
6007 FT150	6007 FT150ZZ	40.0	57.0	1	0.153
	6007 HVZZ	40.0	57.0	1	0.153
	6007 LTZZ	40.0	57.0	1	0.153
6207 FT150	6207 FT150ZZ	42.0	65.0	1.1	0.285
6207 HT200	6207 HT200ZZ	42.0	65.0	1.1	0.280
	6207 HVZZ	42.0	65.0	1.1	0.285
6307 FT150	6307 FT150ZZ	44.0	71.0	1.5	0.446
6307 HT200	6307 HT200ZZ	44.0	71.0	1.5	0.445

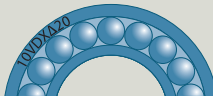
Bearing for special applications (continued)





d			D	B				
					rpm EE*	rpm ZZ*	10 ³ N	10 ³ N
mm	References		mm	mm				
40	6008 FT150	6008 FT150ZZ	68	15	6100	9200	16.8	11.5
	6008 HT200		68	15	2700		16.8	11.5
		6008 HVZZ	68	15		12000	16.8	11.5
	6208 FT150	6208 FT150ZZ	80	18	5500	8300	29	17.9
	6208 HT200	6208 HT200ZZ	80	18	2500	2500	29	17.9
		6208 HVZZ	80	18		11600	29	17.9
	6308 FT150	6308 FT150ZZ	90	23	5100	7600	40.5	23.9
	6308 HT200	6308 HT200ZZ	90	23	2300	2300	40.5	23.9
		6308 HVZZ	90	23		10000	40.5	23.9
	45	6009 FT150	6009 FT150ZZ	75	16	5500	8300	21
6209 FT150		6209 FT150ZZ	85	19	5100	7600	32.5	20.5
6209 HT200		6209 HT200ZZ	85	19	2300	2300	32.5	20.5
		6209 HVZZ	85	19		10000	32.5	20.5
6309 FT150		6309 FT150ZZ	100	25	4200	6800	53	31.5
6309 HT200		6309 HT200ZZ	100	25	2000	2000	53	31.5
50		6010 FT150	6010 FT150ZZ	80	16	5000	7600	21.8
	6210 FT150	6210 FT150ZZ	90	20	4500	7100	35	23.2
	6210 HT200	6210 HT200ZZ	90	20	2100	2000	35	23.2
		6210 HVZZ	90	20		10000	35	23.2
	6310 FT150	6310 FT150ZZ	110	27	4000	6000	62	38
	6310 HT200	6310 HT200ZZ	110	27	1800	1800	62	38
	55		6011 HVZZ	90	18		9600	28.5
65	6013 FT150		100	18	4000		30.5	25
65	6213 FT150		120	23	3600		57	40

* These are the speed limits according to the SNR concept (see pages 85 to 87).

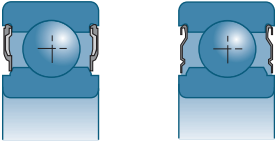

■ TOPLINE bearing for special applications (continued)

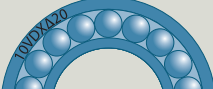

		d3 min	D1 max	r1 max	
References		mm	mm	mm	kg
6008 FT150	6008 FT150ZZ	45.0	63.0	1	0.192
6008 HT200		45.0	63.0	1	0.192
	6008 HVZZ	45.0	63.0	1	0.192
6208 FT150	6208 FT150ZZ	47.0	73.0	1.1	0.373
6208 HT200	6208 HT200ZZ	47.0	73.0	1.1	0.370
	6208 HVZZ	47.0	73.0	1.1	0.364
6308 FT150	6308 FT150ZZ	49.0	81.0	1.5	0.612
6308 HT200	6308 HT200ZZ	49.0	81.0	1.5	0.640
	6308 HVZZ	49.0	81.0	1.5	0.612
6009 FT150	6009 FT150ZZ	50.0	70.0	1	0.243
6209 FT150	6209 FT150ZZ	52.0	78.0	1.1	0.404
6209 HT200	6209 HT200ZZ	52.0	78.0	1.1	0.404
	6209 HVZZ	52.0	78.0	1.1	0.404
6309 FT150	6309 FT150ZZ	54.0	91.0	1.5	0.825
6309 HT200	6309 HT200ZZ	54.0	91.0	1.5	0.850
6010 FT150	6010 FT150ZZ	55.0	75.0	1	0.267
6210 FT150	6210 FT150ZZ	57.0	83.0	1.1	0.453
6210 HT200	6210 HT200ZZ	57.0	83.0	1.1	0.465
	6210 HVZZ	57.0	83.0	1.1	0.453
6310 FT150	6310 FT150ZZ	61.0	99.0	2	1.070
6310 HT200	6310 HT200ZZ	61.0	99.0	2	1.070
	6011 HVZZ	61.0	84.0	1.1	0.387
6013 FT150		71.0	94.0	1.1	0.454
6213 FT150		74.0	111.0	1.5	0.990

Bearing for special applications (continued)

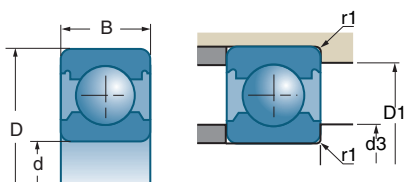



d				D	B			
	References					mm	mm	rpm max*
20	6004 F600	6004 F604	6004 F605	42	12	50	9.40	5.00
	6204 F600	6204 F604	6204 F605	47	14	50	12.80	6.60
25	6205 F600	6205 F604	6205 F605	52	15	50	14.00	7.90
	6305 F600	6305 F604	6305 F605	62	17	50	23.70	12.20
30	6206 F600	6206 F604	6206 F605	62	16	50	19.50	11.30
	6306 F600	6306 F604	6306 F605	72	19	50	28.00	15.80
35	6007 F600	6007 F604	6007 F605	62	14	50	16.00	10.30
	6207 F600	6207 F604	620 7F605	72	17	50	25.50	15.30
40	6008 F600	6008 F604	6008 F605	68	15	50	17.40	11.50
	6208 F600	6208 F604	6208 F605	80	18	50	29.00	17.90
45	6209 F600	6209 F604	6209 F605	85	19	50	32.50	20.50
	6309 F600	6309 F604	6309 F605	100	25	50	53.00	31.50
50	6210 F600	6210 F604	6210 F605	90	20	50	35.00	23.20
	6310 F600		6310 F605	110	27	50	62.00	38.00
55	6211 F600	6211 F604	6211 F605	100	21	50	43.50	29.00
	6311 F600	6311 F604	6311 F605	120	29	50	71.00	44.50
60	6212 F600	6212 F604	6212 F605	110	22	50	52.00	36.00
65	6213 F600	6213 F604	6213 F605	120	23	50	57.00	40.00
70	6214 F600	6214 F604	6214 F605	125	24	50	62.00	44.00
85	6217 F600			150	28	50	83.00	64.00
100	6220 F600			180	34	50	122.00	93.00

* These are the speed limits according to the SNR concept (see pages 85 to 87).

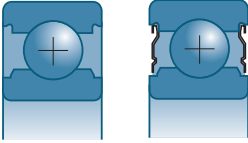

■ Bearing for very high temperatures or for kiln cars

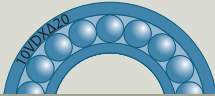

			d3 min	D1 max	r1 max	
References			mm	mm	mm	kg
6004 F600	6004 F604	6004 F605	25.1	37.1	0.6	0.070
6204 F600	6204 F604	6204 F605	26.2	41.1	1.0	0.104
6205 F600	6205 F604	6205 F605	31.4	47	1.0	0.126
6305 F600	6305 F604	6305 F605	33	54	1.1	0.235
6206 F600	6206 F604	6206 F605	37	56	1.0	0.194
6306 F600	6306 F604	6306 F605	41.7	63.5	1.1	0.346
6007 F600	6007 F604	6007 F605	41.2	56.2	1.0	0.151
6207 F600	6207 F604	6207 F605	43.8	63.7	1.1	0.270
6008 F600	6008 F604	6008 F605	46.5	61.9	1.0	0.185
6208 F600	6208 F604	6208 F605	49.8	70.7	1.1	0.352
6209 F600	6209 F604	6209 F605	54.4	76.1	1.1	0.393
6309 F600	6309 F604	6309 F605	59.2	86.7	1.5	0.831
6210 F600	6210 F604	6210 F605	59.4	81.1	1.1	0.441
6310 F600		6310 F605	65.8	95.1	2.0	1.070
6211 F600	6211 F604	6211 F605	65.9	89.6	1.5	0.583
6311 F600	6311 F604	6311 F605	72.1	103.4	2.0	1.352
6212 F600	6212 F604	6212 F605	71	103	1.5	0.731
6213 F600	6213 F604	6213 F605	78.1	106.7	1.5	0.944
6214 F600	6214 F604	6214 F605	84	111.8	1.5	1.028
6217 F600			102.6	137.9	2.0	1.794
6220 F600			121.8	158.7	2.1	3.127

Bearing-inserts

Single-row ball bearings with specific construction properties (outer and/or inner ring shape, attachment system ...)

Bearing – inserts for self-aligning bearing units

→ Definition and capabilities

Bearing inserts for self-aligning ball bearing units are essentially featured by a specific spherical outside diameter enables the bearing to adjust static misalignments in all directions. This self-alignment should only be necessary once, and must not occur permanently in operation.

→ Series

The internal design of bearing inserts correspond to the standard deep groove ball bearings of the 6200 and 6300 series. However, they have extended inner rings for easier fixing on shafts (exception CS200) or tapered bores for assembly with adapter sleeves.

All bearing inserts are sealed on both sides and are available with cylindrical or spherical outer rings (not for UK200H and inserts of 300 series).

■ UC200/UC300 series (spherical outer ring)

- Re-greasable
- Extended inner ring on both sides
- Fixing to shaft using set screws
- Optional design as floating bearing
- Seals on both sides with additional slingers
- Also available with triple lip seals

- SUC200/MUC..FD series: like UC200/UC300 series, version in stainless steel, filled with food grade grease

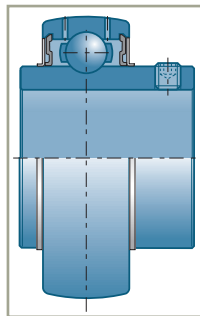

■ US200 series (spherical outer ring)

- Re-greasable
- Extended inner ring on one side
- Fixing to shaft using set screws
- Optional design as floating bearing
- Seals on both sides

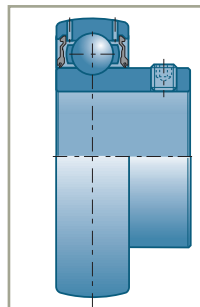

■ **ES200 series (spherical outer ring)**

- Re-greasable
- Extended inner ring on one side
- Fixing to shaft using eccentric locking collar
- Seals on both sides

- SES series: like ES200 series,
version in stainless steel, filled with food grade grease

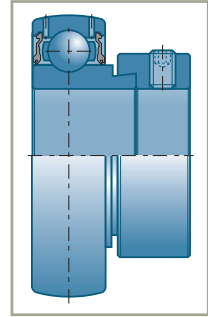

■ **EX200/EX300 series (spherical outer ring)**

- Re-greasable
- Extended inner ring on both sides
- Fixing to shaft using eccentric locking collar
- Seals on both sides with additional slingers
- Also available with triple lip seals

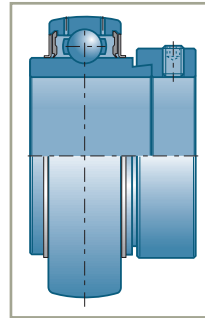

■ **UK200H/UK300H series (spherical outer ring)**

- Re-greasable
- Inner ring with tapered bore for mounting of adapter sleeve
- Fixing to shaft using adapter sleeve
- Seals on both sides with additional slingers
- Also available with triple lip seals

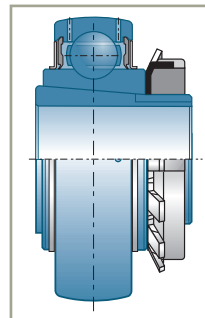

■ **CS200 series (spherical outer ring)**

- Not re-greasable
- Dimensions and tolerances like deep groove ball bearings series 62..
- Fixing to shaft using tight fit
- Seals on both sides

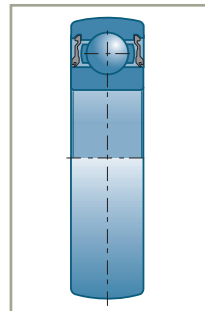

Bearing-inserts (continued)

Bearing-inserts with cylindrical outside diameter

→ Series

■ CUC200 series (cylindrical outer ring)

- Groove in the outer ring for fixing within housing using retaining snap ring
- Lubrication groove in the outer ring with lubrication holes
- Otherwise, design like UC200

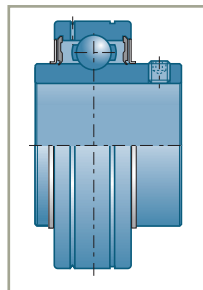

■ CUS200 series (cylindrical outer ring)

- Not re-greasable
- Groove in the outer ring for fixing within housing using retaining snap ring
- Otherwise, design like US200

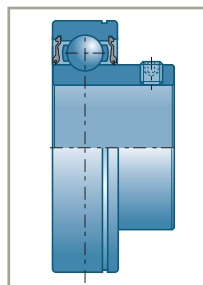

■ CES200 series (cylindrical outer ring)

- Not re-greasable
- Groove in the outer ring for fixing within housing using retaining snap ring
- Otherwise, design like ES200

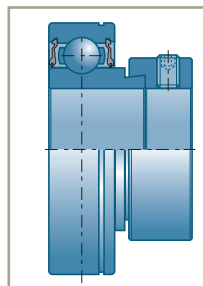

■ CEX200 series (cylindrical outer ring)

- Groove in the outer ring for fixing within housing using retaining snap ring
- Lubrication groove in the outer ring with lubrication holes
- Otherwise, design like EX200

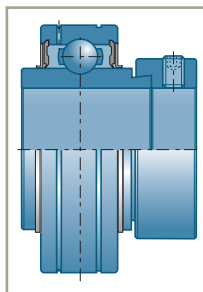



Tolerances and clearances

Ball bearing inserts are manufactured according normal tolerance classes and standard bearings clearance groups:

- Standard temperature inserts (-20°C to 100°C) have a radial internal clearance to group 3.
- High and low temperature inserts (T20/T04) are produced according to group C4.

Suffixes and prefixes

■ Prefixes

SUC	Stainless steel bearing inserts with set screws for use in stainless steel housings
SES	Stainless steel bearing inserts with eccentric locking collar for use in stainless steel housings
MUC	Stainless steel bearing inserts with set screws for use in thermoplastic housings

■ Suffixes

C3	Radial clearance group ISO 3
C4	Radial clearance group ISO 4
G2	Bearing inserts with SNR re-lubrication system (4 bores in outer diameter)
H	Bearing inserts equipped with adapter sleeves
L3	Bearing inserts equipped with 3-lip seal
T04	Bearing inserts for operating temperatures down to -40 °C (-40 °F)
T20	Bearing inserts for operating temperatures up to +200 °C (+400 °F)



As components of self-aligning bearing units, bearing inserts are also listed by type just after the tables of self-aligning bearing units (from page 566).

Bearing-inserts (continued)

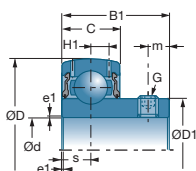

US

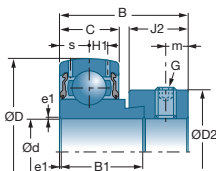

ES - SES

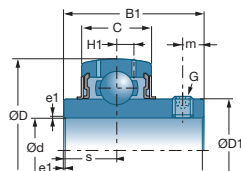

UC - SUC - MUC

d		Adapter sleeve	D	C	B	B1	c	J2	s	D1	D2
mm	References		mm	mm	mm	mm	mm	mm	mm	mm	mm
12	US201G2		40,0	12,0	-	22,0	-	-	6,0	24,6	-
	ES201G2		40,0	12,0	28,6	19,1	-	13,5	6,5	-	27,2
	UC201G2		47,0	16,0	-	31,0	-	-	12,7	29,0	-
	EX201G2		47,0	16,0	43,5	34,0	-	13,5	17,0	-	32,4
	SUC201		47,0	17,0	-	31,0	-	-	12,7	-	-
	SES201		40,0	12,0	28,6	19,1	-	-	6,0	-	28,6
15	US202G2		40,0	12,0	-	22,0	-	-	6,0	24,6	-
	ES202G2		40,0	12,0	28,6	19,1	-	13,5	6,5	-	27,2
	UC202G2		47,0	16,0	-	31,0	-	-	12,7	29,0	-
	EX202G2		47,0	16,0	43,5	34,0	-	13,5	17,0	-	32,4
	SUC202		47,0	17,0	-	31,0	-	-	12,7	-	-
	SES202		40,0	12,0	28,6	19,1	-	-	6,0	-	28,6
17	US203G2		40,0	12,0	-	22,0	-	-	6,0	24,6	-
	ES203G2		40,0	12,0	28,6	19,1	-	13,5	6,5	-	27,2
	UC203G2		47,0	16,0	-	31,0	-	-	12,7	29,0	-
	EX203G2		47,0	16,0	43,5	34,0	-	13,5	17,0	-	32,4
	SUC203		47,0	17,0	-	31,0	-	-	12,7	-	-
	SES203		40,0	12,0	28,6	19,1	-	-	6,0	-	28,6
20	UC204G2		47,0	16,0	-	31,0	-	-	12,7	29,0	-
	US204G2		47,0	14,0	-	25,0	-	-	7,0	29,0	-
	ES204G2		47,0	14,0	30,9	21,4	-	13,5	7,5	-	32,4
	EX204G2		47,0	16,0	43,5	34,0	-	13,5	17,0	-	32,4
	UK205G2	+ H2305	52,0	17,0	35,0	21,0	8,0	-	-	34,0	38,0
	MUC204FD		47,0	17,0	-	31,0	-	-	12,7	29,0	-
	SUC204		47,0	17,0	-	31,0	-	-	12,7	-	-
	SES 204		47,0	14,0	31,0	21,5	-	-	7,0	-	33,3
	UK305G2	+ H2305	62,0	21,0	35,0	27,0	8,0	-	-	35,4	38,0
25	UC205G2		52,0	17,0	-	34,0	-	-	14,3	34,0	-
	US205G2		52,0	15,0	-	27,0	-	-	7,5	34,0	-
	ES205G2		52,0	15,0	30,9	21,4	-	13,5	7,5	-	37,4
	EX205G2		52,0	17,0	44,3	34,8	-	13,5	17,4	-	37,4
	MUC205FD		52,0	17,0	-	34,1	-	-	14,3	34,0	-
	SUC205		52,0	17,0	-	34,1	-	-	14,3	-	-
	SES205		52,0	15,0	31,0	21,5	-	-	7,5	-	38,1
	UK206G2	+ H2306	62,0	19,0	38,0	25,0	8,0	-	-	40,3	45,0
	UC305G2		62,0	21,0	-	38,1	-	-	15,0	35,4	-
	EX305G2		62,0	21,0	46,8	34,9	-	15,9	16,7	-	42,8
	UK306G2	+ H2306	72,0	24,0	38,0	30,0	8,0	-	-	44,6	45,0



Characteristics



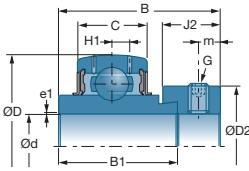

■ Bearing-inserts for self-aligning bearing units (metric)

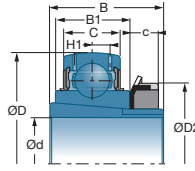

EX



UK + H

	Adapter sleeve	H1	m	G	a*	e1			
References		mm	mm		mm	mm	10 ³ N	10 ³ N	kg
US201G2		3,6	4,0	M5x0,8	2,5	0,6	9,55	4,78	0,090
ES201G2		3,6	5,0	M6x1	3,0	0,6	9,55	4,78	0,140
UC201G2		4,4	4,7	M6x1	3,0	0,6	12,80	6,65	0,210
EX201G2		4,4	5,0	M6x1	3,0	0,6	12,80	6,65	0,290
SUC201		-	5,0	M6x1	-	0,5	10,10	6,80	0,210
SES201		-	5,0	M6x1	-	0,5	7,80	4,50	0,140
US202G2		3,6	4,0	M5x0,8	2,5	0,6	9,55	4,78	0,080
ES202G2		3,6	5,0	M6x1	3,0	0,6	9,55	4,78	0,130
UC202G2		4,4	4,7	M6x1	3,0	0,6	12,80	6,65	0,200
EX202G2		4,4	5,0	M6x1	3,0	0,6	12,80	6,65	0,270
SUC202		-	5,0	M6x1	-	0,5	10,10	6,80	0,190
SES202		-	5,0	M6x1	-	0,5	7,80	4,50	0,120
US203G2		3,6	4,0	M5x0,8	2,5	0,6	9,55	4,78	0,100
ES203G2		3,6	5,0	M6x1	3,0	0,6	9,55	4,78	0,130
UC203G2		4,4	4,7	M6x1	3,0	0,6	12,80	6,65	0,180
EX203G2		4,4	5,0	M6x1	3,0	0,6	12,80	6,65	0,250
SUC203		-	5,0	M6x1	-	0,5	10,10	6,80	0,180
SES203		-	5,0	M6x1	-	0,5	7,80	4,50	0,110
UC204G2		4,4	4,7	M6x1	3,0	0,6	12,80	6,65	0,170
US204G2		4,0	5,0	M6x1	3,0	0,6	12,80	6,65	0,130
ES204G2		4,0	5,0	M6x1	3,0	0,6	12,80	6,65	0,150
EX204G2		4,4	5,0	M6x1	3,0	0,6	12,80	6,65	0,220
UK205G2	+ H2305	4,3	-	-	-	-	14,00	7,88	0,240
MUC204FD		-	4,5	-	-	1,5	10,90	5,30	0,160
SUC204		-	5,0	M6x1	-	0,5	10,10	6,80	0,160
SES 204		-	5,0	M6x1	-	0,5	10,10	6,80	0,170
UK305G2	+ H2305	6,2	-	-	-	-	22,36	11,50	0,490
UC205G2		4,3	5,5	M6x1	3,0	0,6	14,00	7,88	0,210
US205G2		4,3	5,5	M6x1	3,0	0,6	14,00	7,88	0,170
ES205G2		4,3	5,0	M8x1	3,0	0,6	14,00	7,88	0,190
EX205G2		4,3	5,0	M8x1	3,0	0,6	14,00	7,88	0,250
MUC205FD		-	5,0	-	-	1,5	11,90	6,30	0,190
SUC205		-	5,0	M6x1	-	0,5	11,00	8,00	0,200
SES205		-	5,0	M6x1	-	0,5	11,00	8,00	0,200
UK206G2	+ H2306	5,0	-	-	-	-	19,50	11,20	0,380
UC305G2		6,2	6,0	M6x1	3,0	1,5	22,36	11,50	0,350
EX305G2		6,2	6,0	M8x1	4,0	1,5	22,36	11,50	0,430
UK306G2	+ H2306	6,5	-	-	-	-	27,00	15,20	0,586

* Hex set-screw

Bearing-inserts (continued)

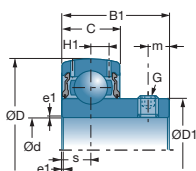

US

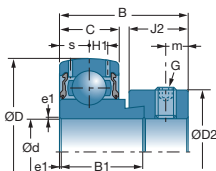

ES - SES

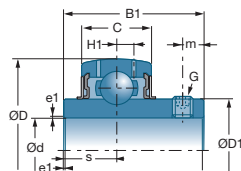

UC - SUC - MUC

d		Adapter sleeve	D	C	B	B1	c	J2	s	D1	D2
mm	References		mm	mm	mm	mm	mm	mm	mm	mm	mm
30	UC206G2	+ H2307	62,0	19,0	-	38,1	-	-	15,9	40,3	-
	US206G2		62,0	16,0	-	30,0	-	8,0	40,3	-	
	ES206G2		62,0	16,0	35,7	23,8	-	15,9	9,0	-	44,1
	EX206G2		62,0	19,0	48,3	36,4	-	15,9	18,2	-	44,1
	MUC206FD		62,0	19,0	-	38,1	-	-	15,9	40,5	-
	SUC206		62,0	19,0	-	38,1	-	-	15,9	-	-
	SES206		62,0	16,0	35,7	23,8	-	-	8,0	-	44,5
	UK207G2		72,0	20,0	43,0	27,0	9,0	-	-	48,0	52,0
	UC306G2		72,0	24,0	-	43,0	-	-	17,0	44,6	-
	EX306G2		72,0	24,0	50,0	36,5	-	17,5	17,5	-	50,0
	UK307G2		80,0	25,0	43,0	33,0	9,0	-	-	48,9	52,0
35	UC207G2	+ H2308	72,0	20,0	-	42,9	-	-	17,5	48,0	-
	US207G2		72,0	17,0	-	32,0	-	8,5	48,0	-	
	ES207G2		72,0	17,0	38,9	25,4	-	17,5	9,5	-	51,1
	EX207G2		72,0	20,0	51,1	37,6	-	17,5	18,8	-	51,1
	MUC207FD		72,0	20,0	-	42,9	-	-	17,5	48,0	-
	SUC207		72,0	20,0	-	42,9	-	-	17,5	-	-
	SES207		72,0	17,0	38,9	25,4	-	-	8,5	-	55,6
	UK208G2		80,0	21,0	46,0	29,0	10,0	-	-	53,0	58,0
	UC307G2		80,0	25,0	-	48,0	-	-	19,0	48,9	-
	EX307G2		80,0	25,0	51,6	38,1	-	17,5	18,3	-	55,0
	UK308G2		90,0	28,0	46,0	35,0	10,0	-	-	56,5	58,0
40	UC208G2	+ H2309	80,0	21,0	-	49,2	-	-	19,0	53,0	-
	US208G2		80,0	18,0	-	34,0	-	9,0	53,0	-	
	ES208G2		80,0	18,0	43,7	30,2	-	18,3	11,0	-	58,0
	EX208G2		80,0	21,0	56,3	42,8	-	18,3	21,4	-	58,0
	MUC208FD		80,0	21,0	-	49,2	-	-	19,0	53,0	-
	SUC208		80,0	21,0	-	49,2	-	-	19,0	-	-
	SES208		80,0	18,0	43,7	30,2	-	-	9,0	-	60,3
	UK209G2		85,0	22,0	50,0	30,0	11,0	-	-	57,2	65,0
	UC308G2		90,0	28,0	-	52,0	-	-	19,0	56,5	-
	EX308G2		90,0	28,0	57,1	41,3	-	20,6	19,8	-	63,5
	UK309G2		100,0	30,0	50,0	38,0	11,0	-	-	61,8	65,0
45	UC209G2	+ H2310	85,0	22,0	-	49,2	-	-	19,0	57,2	-
	US209G2		85,0	19,0	-	41,2	-	10,2	57,2	-	
	ES209G2		85,0	19,0	43,7	30,2	-	18,3	11,0	-	63,5
	EX209G2		85,0	22,0	56,3	42,8	-	18,3	21,4	-	63,5
	SUC209		85,0	22,0	-	49,2	-	-	19,0	-	-
	SES209		85,0	19,0	43,7	30,2	-	-	9,5	-	36,5
	UK210G2		90,0	23,0	55,0	31,0	12,0	-	-	61,8	70,0



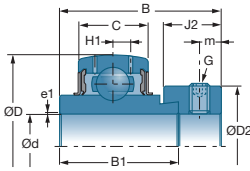

■ Bearing-inserts for self-aligning bearing units (metric) (continued)

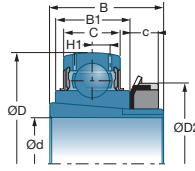

EX

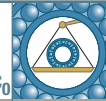

UK + H

	Adapter sleeve	H1	m	G	a*	e1			
References		mm	mm		mm	mm	10 ³ N	10 ³ N	kg
UC206G2		5,0	5,5	M6x1	3,0	0,6	19,50	11,20	0,320
US206G2		5,0	6,0	M6x1	3,0	0,6	19,50	11,20	0,270
ES206G2		5,0	6,0	M6x1	3,0	0,6	19,50	11,20	0,330
EX206G2		5,0	6,0	M6x1	3,0	0,6	19,50	11,20	0,410
MUC206FD		-	5,0	-	-	1,5	16,70	9,00	0,310
SUC206		-	5,0	M6x1	-	0,5	15,30	11,50	0,320
SES206		-	6,0	M8x1	-	0,5	15,30	11,50	0,320
UK207G2	+ H2307	5,8	-	-	-	-	25,70	15,20	0,535
UC306G2		6,5	6,0	M6x1	3,0	1,5	27,00	15,20	0,560
EX306G2		6,5	6,7	M8x1	4,0	1,5	27,00	15,20	0,680
UK307G2	+ H2307	7,2	-	-	-	-	33,50	19,20	0,915
UC207G2		5,8	6,5	M8x1	4,0	1,1	25,70	15,20	0,470
US207G2		5,7	6,5	M6x1	3,0	0,6	25,70	15,20	0,420
ES207G2		5,7	6,5	M8x1	4,0	1,1	25,70	15,20	0,500
EX207G2		5,8	6,5	M8x1	4,0	1,1	25,70	15,20	0,600
MUC207FD		-	6,0	-	-	2,0	16,70	9,00	0,480
SUC207		-	6,0	M8x1	-	1,0	20,10	15,60	0,470
SES207		-	6,5	M8x1	-	1,0	20,10	15,60	0,510
UK208G2	+ H2308	6,3	-	-	-	-	29,60	18,20	0,704
UC307G2		7,2	8,0	M8x1	4,0	2,0	33,50	19,20	0,710
EX307G2		7,2	6,7	M8x1	4,0	2,0	33,50	19,20	0,800
UK308G2	+ H2308	8,5	-	-	-	-	40,56	24,00	1,034
UC208G2		6,3	8,0	M8x1	4,0	1,1	29,60	18,20	0,640
US208G2		6,2	7,0	M8x1	4,0	1,1	29,60	18,20	0,600
ES208G2		6,2	6,5	M8x1	4,0	1,1	29,60	18,20	0,650
EX208G2		6,3	6,5	M8x1	4,0	1,1	29,60	18,20	0,780
MUC208FD		-	8,0	-	-	2,0	22,00	12,30	0,620
SUC208		-	8,0	M8x1	-	1,0	22,80	18,20	0,630
SES208		-	6,5	M8x1	-	1,0	22,80	18,20	0,640
UK209G2	+ H2309	6,8	5,0	-	-	-	31,85	20,80	0,810
UC308G2		8,5	10,0	M10x1,25	5,0	2,0	40,56	24,00	0,960
EX308G2		8,5	8,0	M10x1,25	5,0	2,0	40,56	24,00	1,080
UK309G2	+ H2309	9,0	-	-	-	-	53,00	31,80	1,470
UC209G2		6,8	8,0	M8x1	4,0	1,1	31,85	20,80	0,680
US209G2		6,5	8,2	M8x1	4,0	1,1	31,85	20,80	0,650
ES209G2		6,5	6,5	M8x1	4,0	1,1	31,85	20,80	0,690
EX209G2		6,8	6,5	M8x1	4,0	1,1	31,85	20,80	0,870
SUC209		-	8,0	M10x1,25	-	1,0	25,70	20,80	0,690
SES209		-	6,5	M8x1	-	1,0	25,70	20,80	0,670
UK210G2	+ H2310	6,5	-	-	-	-	35,10	23,20	0,952

* Hex set-screw

Bearing-inserts (continued)

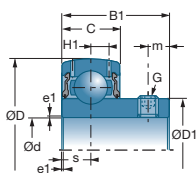

US

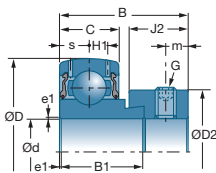

ES - SES

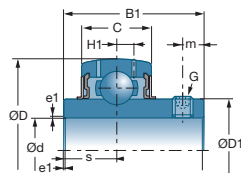

UC - SUC - MUC

d		Adapter sleeve	D	C	B	B1	c	J2	s	D1	D2
mm	References		mm	mm	mm	mm	mm	mm	mm	mm	mm
50	UC309G2	+ H2310	100,0	30,0	-	57,0	-	-	22,0	61,8	-
	EX309G2		100,0	30,0	58,7	42,9	-	20,6	19,8	-	70,0
	UK310G2		110,0	32,0	55,0	40,0	12,0	-	-	68,7	70,0
50	UC210G2	+ H2311	90,0	23,0	-	51,6	-	-	19,0	61,8	-
	US210G2		90,0	20,0	-	43,5	-	-	10,9	61,8	-
	ES210G2		90,0	20,0	43,7	30,2	-	18,3	11,0	-	67,2
	EX210G2		90,0	23,0	62,7	49,2	-	18,3	24,6	-	67,2
	SUC210		90,0	24,0	-	51,6	-	-	19,0	-	-
	SES210		90,0	20,0	43,7	30,2	-	-	10,0	-	69,9
	UK211G2		100,0	25,0	59,0	33,0	12,5	-	-	69,0	75,0
	UC310G2		110,0	32,0	-	61,0	-	-	22,0	68,7	-
	EX310G2		110,0	32,0	66,6	49,2	-	22,2	24,6	-	76,2
	UK311G2		120,0	34,0	59,0	43,0	12,5	-	-	74,9	75,0
55	UC211G2	+ H2312	100,0	25,0	-	55,6	-	-	22,2	69,0	-
	US211G2		100,0	23,0	-	45,3	-	-	11,8	69,0	-
	ES211G2		100,0	24,0	48,4	32,5	-	20,7	12,0	-	74,5
	EX211G2		100,0	25,0	71,3	55,4	-	20,7	27,7	-	74,5
	SUC211		100,0	25,0	-	55,6	-	-	22,2	-	-
	SES211		100,0	21,0	48,4	32,5	-	-	10,5	-	76,2
	UK212G2		110,0	27,0	62,0	36,0	13,0	-	-	74,9	80,0
	UC311G2		120,0	34,0	-	66,0	-	-	25,0	74,9	-
	EX311G2		120,0	34,0	73,0	55,6	-	22,2	27,8	-	83,0
	UK312G2		130,0	36,0	62,0	47,0	13,0	-	-	81,0	80,0
60	UC212G2	+ H2313	110,0	27,0	-	65,1	-	-	25,4	74,9	-
	US212G2		110,0	24,0	-	53,7	-	-	14,9	74,9	-
	ES212G2		110,0	24,0	49,3	33,4	-	22,3	12,0	-	82,0
	EX212G2		110,0	27,0	77,7	61,8	-	22,3	30,9	-	82,0
	SUC212		110,0	27,0	-	65,1	-	-	25,4	-	-
	SES212		110,0	22,0	53,1	37,1	-	-	11,0	-	84,2
	UK213G2		120,0	28,0	65,0	36,0	14,0	-	-	82,0	85,0
	UC312G2		130,0	36,0	-	71,0	-	-	26,0	81,0	-
	EX312G2		130,0	36,0	79,4	61,9	-	23,9	31,0	-	89,0
	UK313G2		140,0	38,0	65,0	49,0	14,0	-	-	87,5	85,0
65	UC213G2	+ H2315	120,0	28,0	-	65,1	-	-	25,4	82,0	-
	EX213G2		120,0	28,0	85,7	68,2	-	23,5	34,1	-	86,0
	UK215G2		130,0	30,0	73,0	41,0	15,0	-	-	91,5	98,0
	UC313G2		140,0	38,0	-	75,0	-	-	30,0	87,5	-
	EX313G2		140,0	38,0	85,7	65,1	-	27,0	32,5	-	97,0
	UK315G2		160,0	42,0	73,0	55,0	15,0	-	-	100,5	98,0





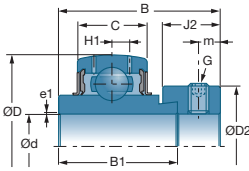

■ Bearing-inserts for self-aligning bearing units (metric) (continued)

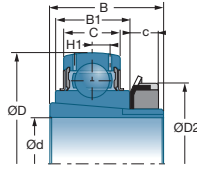

EX



UK + H

	Adapter sleeve	H1	m	G	a*	e1			
References		mm	mm		mm	mm	10 ³ N	10 ³ N	kg
UC309G2 EX309G2 UK310G2	+ H2310	9,0 9,0 9,9	10,0 8,0 -	M10x1,25 M10x1,25 -	5,0 5,0 -	2,0 2,0 -	53,00 53,00 62,00	31,80 31,80 37,80	1,280 1,450 1,742
UC210G2 US210G2 ES210G2 EX210G2 SUC210 SES210 UK211G2 UC310G2 EX310G2 UK311G2	+ H2311	6,5 6,5 6,5 6,5 - - 7,2 9,9 9,9 10,6	9,0 9,2 6,5 6,5 10,0 6,5 - 12,0 8,7 -	M10x1,25 M8x1 M8x1 M8x1 M10x1,25 M8x1 - M12x1,25 M10x1,25 -	5,0 4,0 4,0 4,0 - - - 6,0 5,0 -	1,1 1,1 1,1 1,1 1,0 1,0 - 2,0 2,0 -	35,10 35,10 35,10 35,10 27,50 27,50 43,55 62,00 62,00 71,50	23,20 23,20 23,20 23,20 23,70 23,70 29,20 37,80 37,80 44,80	0,800 0,760 0,800 1,010 0,770 0,750 1,190 1,650 1,860 2,200
UC211G2 US211G2 ES211G2 EX211G2 SUC211 SES211 UK212G2 UC311G2 EX311G2 UK312G2	+ H2312	7,2 7,2 7,2 7,2 - - 8,2 10,6 10,6 11,3	9,0 9,8 8,0 8,0 10,0 8,0 - 12,0 9,0 -	M10x1,25 M10x1,25 M10x1,25 M10x1,25 M10x1,25 M10x1,25 - M12x1,25 M10x1,25 -	5,0 5,0 5,0 5,0 - - - 6,0 5,0 -	1,1 1,1 1,1 1,5 1,0 1,0 - 2,0 2,0 -	43,55 43,55 43,55 43,55 34,00 34,00 52,50 71,50 71,50 81,60	29,20 29,20 29,20 29,20 25,50 25,50 32,80 44,80 44,80 51,80	1,120 1,070 0,870 1,390 1,060 1,030 1,511 1,900 2,300 2,541
UC212G2 US212G2 ES212G2 EX212G2 SUC212 SES212 UK213G2 UC312G2 EX312G2 UK313G2	+ H2313	8,2 8,0 8,0 8,2 - - 8,0 11,3 11,3 12,1	10,5 9,8 8,0 8,0 10,0 8,0 - 12,0 9,0 -	M10x1,25 M10x1,25 M10x1,25 M10x1,25 M10x1,25 M10x1,25 - M12x1,25 M10x1,25 -	5,0 5,0 5,0 5,0 - - - 6,0 5,0 -	1,1 1,1 1,1 1,5 1,0 1,0 - 2,0 2,0 -	52,50 52,50 52,50 52,50 41,00 41,00 57,20 81,60 81,60 93,86	32,80 32,80 32,80 32,80 31,50 31,50 40,00 51,80 51,80 60,50	1,530 1,300 1,200 1,870 1,470 1,340 1,917 2,600 2,890 3,267
UC213G2 EX213G2 UK215G2 UC313G2 EX313G2 UK315G2	+ H2315	8,0 8,0 9,0 12,1 12,1 13,5	12,0 8,5 - 12,0 11,5 -	M12x1,25 M10x1,25 - M12x1,25 M12x1,25 -	6,0 5,0 - 6,0 6,0 -	1,5 1,5 - 2,0 2,0 -	57,20 57,20 66,00 93,86 93,86 113,36	40,00 40,00 49,50 60,50 60,50 76,80	1,860 2,410 2,720 3,250 3,660 5,030

* Hex set-screw

Bearing-inserts (continued)

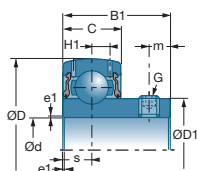

US

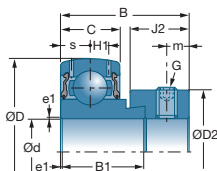

ES - SES

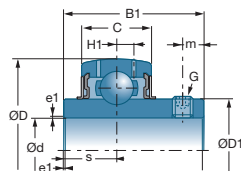

UC - SUC - MUC

d		Adapter sleeve	D	C	B	B1	c	J2	s	D1	D2
mm	References		mm	mm	mm	mm	mm	mm	mm	mm	mm
70	UC214G2	+ H2316	125,0	30,0	-	74,6	-	-	30,2	86,5	-
	EX214G2		125,0	30,0	85,7	68,2	-	23,5	34,1	-	96,8
	UK216G2		140,0	33,0	78,0	44,0	17,0	-	-	98,0	105,0
	UC314G2	+ H2316	150,0	40,0	-	78,0	-	-	33,0	94,0	-
	EX314G2		150,0	40,0	92,1	68,3	-	30,2	34,2	-	102,0
	UK316G2		170,0	44,0	78,0	55,0	17,0	-	-	107,9	105,0
75	UC215G2	+ H2317	130,0	30,0	-	77,8	-	-	33,3	91,5	-
	EX215G2		130,0	30,0	92,1	74,6	-	23,9	37,3	-	102,0
	UK217G2		150,0	35,0	82,0	44,0	18,0	-	-	105,1	110,0
	UC315G2	+ H2317	160,0	42,0	-	82,0	-	-	32,0	100,5	-
	EX315G2		160,0	42,0	100,0	74,6	-	31,8	37,3	-	113,0
	UK317G2		180,0	46,0	82,0	60,0	18,0	-	-	114,0	110,0
80	UC216G2	+ H2318	140,0	33,0	-	82,6	-	-	33,3	98,0	-
	EX216G2		140,0	33,0	95,2	74,6	-	27,0	37,3	-	110,0
	UK218G2		160,0	37,0	86,0	48,0	18,0	-	-	111,0	120,0
	UC316G2	+ H2318	170,0	44,0	-	86,0	-	-	34,0	107,9	-
	EX316G2		170,0	44,0	106,4	81,0	-	31,8	40,5	-	119,0
	UK318G2		190,0	48,0	86,0	60,0	18,0	-	-	120,0	120,0
85	UC217G2	+ H2319	150,0	35,0	-	85,7	-	-	34,1	105,1	-
	EX217G2		150,0	35,0	73,2	53,2	-	27,0	23,4	-	119,0
	UK317G2		180,0	46,0	-	96,0	-	-	40,0	114,0	-
	UC317G2	+ H2319	180,0	46,0	109,5	84,1	-	31,8	42,0	-	127,0
	EX317G2		180,0	46,0	90,0	66,0	19,0	-	-	126,5	125,0
	UK319G2		200,0	50,0	90,0	66,0	19,0	-	-	126,5	125,0
90	UC218G2	+ H2320	160,0	37,0	-	96,0	-	-	39,7	111,0	-
	EX218G2		160,0	37,0	72,5	55,0	-	24,0	24,5	-	120,0
	UK318G2		190,0	48,0	-	96,0	-	-	40,0	120,0	-
	UC318G2	+ H2320	190,0	48,0	115,9	87,3	-	36,5	43,6	-	133,0
	EX318G2		190,0	48,0	97,0	68,0	20,0	-	-	134,5	130,0
	UK320G2		215,0	54,0	97,0	68,0	20,0	-	-	134,5	130,0
95	UC319G2		200,0	50,0	-	103,0	-	-	41,0	126,5	-
	EX319G2		200,0	50,0	122,3	93,7	-	36,5	46,8	-	140,0
100	UC320G2	+ H2322	215,0	54,0	-	108,0	-	-	42,0	134,5	-
	EX320G2		215,0	54,0	128,6	100,0	-	36,5	50,0	-	146,0
	UK322G2		240,0	60,0	105,0	80,0	21,0	-	-	147,7	145,0
105	UC321G2		225,0	57,0	-	112,0	-	-	44,0	140,5	-
110	UC322G2	+ H2324	240,0	60,0	-	117,0	-	-	46,0	149,0	-
	UK324G2		260,0	64,0	112,0	86,0	22,0	-	-	162,1	155,0





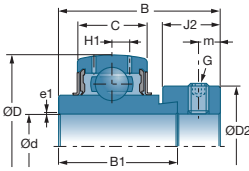

■ Bearing-inserts for self-aligning bearing units (metric) (continued)

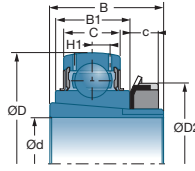

EX



UK + H

	Adapter sleeve	H1	m	G	a*	e1			
References		mm	mm		mm	mm	10 ³ N	10 ³ N	kg
UC214G2	+ H2316	9,0	12,0	M12x1,25	6,0	2,0	62,00	45,00	2,050
EX214G2		9,0	8,5	M10x1,25	5,0	2,0	62,00	45,00	2,570
UK216G2		10,3	-	-	-	-	72,50	54,20	3,240
UC314G2		12,8	12,0	M12x1,25	6,0	2,5	104,26	68,00	3,950
EX314G2		12,8	12,0	M12x1,25	6,0	2,5	104,26	68,00	4,500
UK316G2		14,5	-	-	-	-	122,85	86,50	5,830
UC215G2	+ H2317	9,0	12,0	M12x1,25	6,0	2,0	66,00	49,50	2,210
EX215G2		9,0	8,5	M10x1,25	5,0	2,0	66,00	49,50	2,840
UK217G2		11,0	-	-	-	-	83,20	63,80	3,870
UC315G2		13,5	14,0	M14x1,5	6,0	2,5	113,36	76,80	4,330
EX315G2		13,5	13,0	M16x1,5	8,0	2,5	113,36	76,80	5,340
UK317G2		15,5	-	-	-	-	132,60	96,50	6,890
UC216G2	+ H2318	10,3	14,0	M12x1,25	6,0	2,0	72,50	54,20	2,790
EX216G2		10,3	10,3	M12x1,25	6,0	2,0	72,50	54,20	3,120
UK218G2		12,0	-	-	-	-	96,00	71,50	4,690
UC316G2		14,5	14,0	M14x1,5	6,0	3,0	122,85	86,50	5,570
EX316G2		14,5	13,0	M16x1,5	8,0	3,0	122,85	86,50	6,700
UK318G2		16,5	-	-	-	-	143,00	108,00	7,940
UC217G2	+ H2319	11,0	14,0	M12x1,25	6,0	2,0	83,20	63,80	3,380
EX217G2		11,0	10,0	M12x1,25	6,0	2,0	83,20	63,80	3,720
UC317G2		15,5	16,0	M16x1,5	8,0	3,0	132,60	96,50	6,840
EX317G2		15,5	13,0	M16x1,5	8,0	3,0	132,60	96,50	7,960
UK319G2		16,7	-	-	-	-	156,00	122,00	9,230
UC218G2		+ H2320	12,0	14,0	M12x1,25	6,0	2,0	96,00	71,50
EX218G2	12,0		9,5	M12x1,25	6,0	2,0	96,00	71,50	4,900
UC318G2	16,5		16,0	M16x1,5	8,0	3,5	143,00	108,00	7,870
EX318G2	16,5		14,5	M20x1,5	8,0	3,0	143,00	108,00	9,100
UK320G2	19,0		-	-	-	-	171,60	140,00	10,970
UC319G2			16,7	18,0	M16x1,5	8,0	3,0	156,00	122,00
EX319G2		16,7	14,5	M20x1,5	8,0	3,0	156,00	122,00	10,400
UC320G2	+ H2322	19,0	18,0	M18x1,5	9,0	3,5	171,60	140,00	11,200
EX320G2		19,0	14,5	M20x1,5	9,0	3,5	171,60	140,00	13,000
UK322G2		21,0	-	-	-	-	205,00	178,00	17,640
UC321G2		20,0	18,0	M18x1,5	9,0	3,0	182,00	155,00	12,200
UC322G2	+ H2324	21,0	18,0	M18x1,5	9,0	3,0	205,00	178,00	14,300
UK324G2		22,0	-	-	-	-	228,00	208,00	21,190

* Hex set-screw

Bearing-inserts (continued)

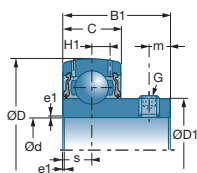

US

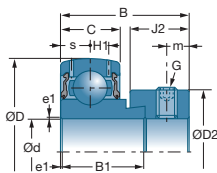

ES - SES

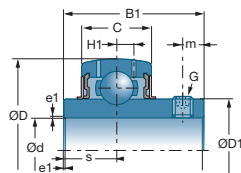

UC - SUC - MUC

d		Adapter sleeve	D	C	B	B1	c	J2	s	D1	D2
mm	References		mm	mm	mm	mm	mm	mm	mm	mm	mm
115	UK326G2	+ H2326	280,0	68,0	121,0	92,0	23,0	-	-	176,1	165,0
120	UC324G2		260,0	64,0	-	126,0	-	-	51,0	163,0	-
125	UK328G2	+ H2328	300,0	73,0	131,0	98,0	24,0	-	-	189,0	180,0
130	UC326G2		280,0	68,0	-	135,0	-	-	54,0	177,0	-
140	UC328G2		300,0	73,0	-	145,0	-	-	59,0	190,0	-

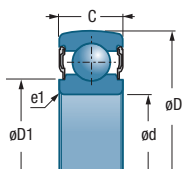

d		D	C	D1	e1			
mm	References	mm	mm	mm	mm	10 ³ N	10 ³ N	kg
12	CS201	40	12	24,6	0,6	9,58	4,78	0,065
15	CS202	40	12	24,6	0,6	9,58	4,78	0,060
17	CS203	40	12	24,6	0,6	9,58	4,78	0,050
20	CS204	47	14	29,0	0,6	12,80	6,65	0,095
25	CS205	52	15	34,0	0,6	14,00	7,88	0,110
30	CS206	62	16	40,3	0,6	19,50	11,50	0,180
35	CS207	72	17	48,0	0,6	25,50	15,20	0,250
40	CS208	80	18	53,0	1,1	29,60	18,20	0,320
45	CS209	85	19	57,2	1,1	31,50	20,80	0,370
50	CS210	90	20	61,8	1,1	35,10	23,20	0,410



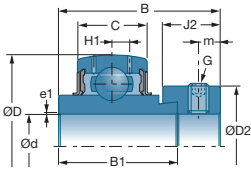

■ Bearing-inserts for self-aligning bearing units (metric) (continued)

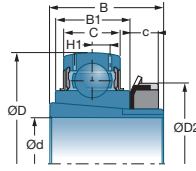

EX



UK + H

	Adapter sleeve	H1	m	G	a*	e1			
References		mm	mm		mm	mm	10 ³ N	10 ³ N	kg
UK326G2	+ H2326	23,0	-	-	-	-	252,00	242,00	27,900
UC324G2		22,0	18,0	M18x1,5	9,0	3,0	228,00	208,00	18,500
UK328G2	+ H2328	25,0	-	-	-	-	275,00	272,00	34,450
UC326G2		23,0	20,0	M20x1,5	10,0	4,0	252,00	242,00	23,000
UC328G2		25,0	20,0	M20x1,5	10,0	4,0	275,00	272,00	28,500

* Hex set-screw

Bearing-inserts (continued)

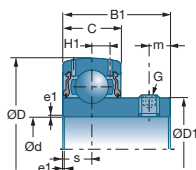

US

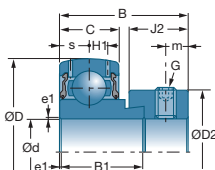

ES - SES

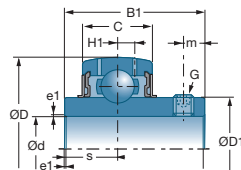

UC - SUC - MUC

d		Adapter sleeve	D	C	B	B1	c	J2	s	D1	D2
inch	References		mm	mm	mm	mm	mm	mm	mm	mm	mm
1/2	US201-08G2		40,0	12,0	-	22,0	-	-	6,0	24,6	-
	ES201-08G2		40,0	12,0	28,6	19,1	-	13,5	6,5	-	27,2
	UC201-08G2		47,0	16,0	-	31,0	-	-	12,7	29,0	-
	EX201-08G2		47,0	16,0	43,5	34,0	-	13,5	17,0	-	32,4
5/8	US202-10G2		40,0	12,0	-	22,0	-	-	6,0	24,6	-
	ES202-10G2		40,0	12,0	28,6	19,1	-	13,5	6,5	-	27,2
	UC202-10G2		47,0	16,0	-	31,0	-	-	12,7	29,0	-
	EX202-10G2		47,0	16,0	43,5	34,0	-	13,5	17,0	-	32,4
	MUC202-10FD		47,0	17,0	31,0	31,0	-	-	12,7	29,0	-
11/16	US203-11G2		40,0	12,0	-	22,0	-	-	6,0	24,6	-
	ES203-11G2		40,0	12,0	28,6	19,1	-	13,5	6,5	-	27,2
	UC203-11G2		47,0	16,0	-	31,0	-	-	12,7	29,0	-
	EX203-11G2		47,0	16,0	43,5	34,0	-	13,5	17,0	-	32,4
3/4	US204-12G2		47,0	14,0	-	25,0	-	-	7,0	29,0	-
	ES204-12G2		47,0	14,0	30,9	21,4	-	13,5	7,5	-	32,4
	UC204-12G2		47,0	16,0	-	31,0	-	-	12,7	29,0	-
	EX204-12G2		47,0	16,0	43,5	34,0	-	13,5	17,0	-	32,4
	MUC204-12FD		47,0	17,0	31,0	31,0	-	-	12,7	29,0	-
	SUC204-12		47,0	17,0	-	31,0	-	-	12,7	-	-
	SES204-12		47,0	14,0	-	21,5	-	-	7,0	-	33,3
	UK205G2	+ H2305-12	52,0	17,0	35,0	21,0	8,0	-	-	34,0	38,0
	UK305G2	+ H2305-12	62,0	21,0	35,0	27,0	8,0	-	-	35,4	38,0
7/8	US205-14G2		52,0	15,0	-	27,0	-	-	7,5	34,0	-
	ES205-14G2		52,0	15,0	30,9	21,4	-	13,5	7,5	-	37,4
	UC205-14G2		52,0	17,0	-	34,0	-	-	14,3	34,0	-
	EX205-14G2		52,0	17,0	44,3	34,8	-	13,5	17,4	-	37,4
	UK206G2	+ H2306-14	62,0	19,0	38,0	25,0	8,0	-	-	40,3	45,0
	UC305-14G2		62,0	21,0	38,0	-	-	-	15,0	35,4	-
	EX305-14G2		62,0	21,0	46,8	34,9	-	15,9	16,7	-	42,8
	UK306G2	+ H2306-14	72,0	24,0	38,0	30,0	8,0	-	-	44,6	45,0
15/16	US205-15G2		52,0	15,0	-	27,0	-	-	7,5	34,0	-
	ES205-15G2		52,0	15,0	30,9	21,4	-	13,5	7,5	-	37,4
	UC205-15G2		52,0	17,0	-	34,0	-	-	14,3	34,0	-
	EX205-15G2		52,0	17,0	44,3	34,8	-	13,5	17,4	-	37,4
	UK206G2	+ H2306-15	62,0	19,0	38,0	25,0	8,0	-	-	40,3	45,0
	UC305-15G2		62,0	21,0	-	38,0	-	-	15,0	35,4	-
	EX305-15G2		62,0	21,0	46,8	34,9	-	15,9	16,7	-	42,8
	UK306G2	+ H2306-15	72,0	24,0	38,0	30,0	8,0	-	-	44,6	45,0





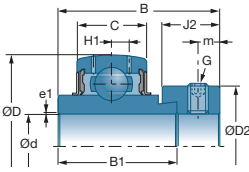

■ Bearing-inserts for self-aligning bearings unit (inch)

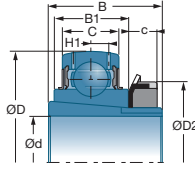

EX



UK + H

	Adapter sleeve	H1	m	G	a*	e1			
References		mm	mm		mm	mm	10°N	10°N	kg
US201-08G2		3,6	4,0	10-32UNF	3/32	0,6	9,55	4,78	0,090
ES201-08G2		3,6	5,0	1/4-28UNF	1/8	0,6	9,55	4,78	0,140
UC201-08G2		4,4	4,7	1/4-28UNF	1/8	0,6	12,80	6,65	0,210
EX201-08G2		4,4	5,0	1/4-28UNF	1/8	0,6	12,80	6,65	0,280
US202-10G2		3,6	4,0	10-32UNF	3/32	0,6	9,55	4,78	0,080
ES202-10G2		3,6	5,0	1/4-28UNF	1/8	0,6	9,55	4,78	0,130
UC202-10G2		4,4	4,7	1/4-28UNF	1/8	0,6	12,80	6,65	0,200
EX202-10G2		4,4	5,0	1/4-28UNF	1/8	0,6	12,80	6,65	0,260
MUC202-10FD		-	4,5	-	3 mm	1,0	10,90	5,30	0,181
US203-11G2		3,6	4,0	10-32UNF	3/32	0,6	9,55	4,78	0,100
ES203-11G2		3,6	5,0	1/4-28UNF	1/8	0,6	9,55	4,78	0,130
UC203-11G2		4,4	4,7	1/4-28UNF	1/8	0,6	12,80	6,65	0,180
EX203-11G2		4,4	5,0	1/4-28UNF	1/8	0,6	12,80	6,65	0,240
US204-12G2		4,0	5,0	1/4-28UNF	1/8	0,6	12,80	6,65	0,130
ES204-12G2		4,0	5,0	1/4-28UNF	1/8	0,6	12,80	6,65	0,150
UC204-12G2		4,4	4,7	1/4-28UNF	1/8	0,6	12,80	6,65	0,170
EX204-12G2		4,4	5,0	1/4-28UNF	1/8	0,6	12,80	6,65	0,220
MUC204-12FD		-	4,5	-	3 mm	1,5	10,90	5,30	0,181
SUC204-12		-	5,0	M6x1	3 mm	0,5	10,10	6,80	0,160
SES204-12		-	5,0	M6x1	3 mm	0,5	10,10	6,80	0,170
UK205G2	+ H2305-12	4,3	-	-	-	-	14,00	7,88	0,240
UK305G2	+ H2305-12	6,2	-	-	-	-	22,36	11,50	0,490
US205-14G2		4,3	5,5	1/4-28UNF	1/8	0,6	14,00	7,88	0,180
ES205-14G2		4,3	5,0	1/4-28UNF	1/8	0,6	14,00	7,88	0,190
UC205-14G2		4,3	5,5	1/4-28UNF	1/8	0,6	14,00	7,88	0,210
EX205-14G2		4,3	5,0	1/4-28UNF	1/8	0,6	14,00	7,88	0,250
UK206G2	+ H2306-14	5,0	-	-	-	-	19,50	11,20	0,400
UC305-14G2		6,2	6,0	1/4-28UNF	1/8	1,5	22,36	11,50	0,350
EX305-14G2		6,2	6,0	5/16-24UNF	5/32	1,5	22,36	11,50	0,430
UK306G2	+ H2306-14	6,5	-	-	-	-	27,00	15,20	0,610
US205-15G2		4,3	5,5	1/4-28UNF	1/8	0,6	14,00	7,88	0,180
ES205-15G2		4,3	5,0	1/4-28UNF	1/8	0,6	14,00	7,88	0,190
UC205-15G2		4,3	5,5	1/4-28UNF	1/8	0,6	14,00	7,88	0,210
EX205-15G2		4,3	5,0	1/4-28UNF	1/8	0,6	14,00	7,88	0,250
UK206G2	+ H2306-15	5,0	-	-	-	-	19,50	11,20	0,390
UC305-15G2		6,2	6,0	1/4-28UNF	1/8	1,5	22,36	11,50	0,350
EX305-15G2		6,2	6,0	5/16-24UNF	5/32	1,5	22,36	11,50	0,430
UK306G2	+ H2306-15	6,5	-	-	-	-	27,00	15,20	0,600

* Hex set-screw

Bearing-inserts (continued)

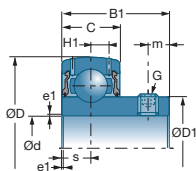

US

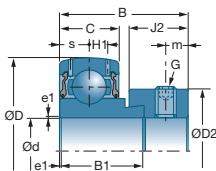

ES - SES

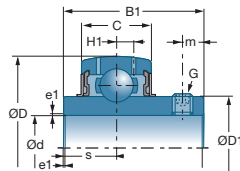

UC - SUC - MUC

d		Adapter sleeve	D	C	B	B1	c	J2	s	D1	D2
inch	References		mm	mm	mm	mm	mm	mm	mm	mm	mm
1	US205-16G2	+ H2306-16	52,0	15,0	-	27,0	-	-	7,5	34,0	-
	ES205-16G2		52,0	15,0	30,9	21,4	-	13,5	7,5	-	38,1
	UC205-16G2		52,0	17,0	-	34,0	-	-	14,3	34,0	-
	EX205-16G2		52,0	17,0	44,3	34,8	-	13,5	17,4	-	38,1
	MUC205-16FD		52,0	17,0	-	34,1	-	-	14,3	34,0	-
	SUC205-16		52,0	17,0	-	34,1	-	-	14,3	-	-
	SES205-16		52,0	15,0	31,0	21,5	-	-	7,5	-	38,1
	UK206G2		62,0	19,0	38,0	25,0	8,0	-	-	-	45,0
	UC305-16G2		62,0	21,0	-	38,0	-	-	15,0	35,4	-
	EX305-16G2		62,0	21,0	46,8	34,9	-	15,9	16,7	-	42,8
UK306G2	72,0	24,0	38,0	30,0	8,0	-	-	44,6	45,0		
1-1/8	US206-18G2	+ H2307-18	62,0	16,0	-	30,0	-	-	8,0	40,3	-
	ES206-18G2		62,0	16,0	35,7	23,8	-	15,9	9,0	-	44,5
	UC206-18G2		62,0	19,0	-	38,1	-	-	15,9	40,3	-
	EX206-18G2		62,0	19,0	48,3	36,4	-	15,9	18,2	-	44,5
	MUC206-18FD		62,0	19,0	-	38,1	-	-	15,9	40,5	-
	SUC207G2		72,0	20,0	43,0	27,0	9,0	-	-	48,0	52,0
	UC306-18G2		72,0	24,0	-	43,0	-	-	17,0	44,6	-
	EX306-18G2		72,0	24,0	50,0	36,5	-	17,5	17,5	-	50,0
	UK307G2		80,0	25,0	43,0	33,0	9,0	-	-	48,9	52,0
	1-3/16		US206-19G2	+ H2307-19	62,0	16,0	-	30,0	-	-	8,0
ES206-19G2		62,0	16,0		35,7	23,8	-	15,9	9,0	-	44,5
UC206-19G2		62,0	19,0		-	38,1	-	-	15,9	40,3	-
EX206-19G2		62,0	19,0		48,3	36,4	-	15,9	18,2	-	44,5
MUC206-19FD		62,0	19,0		-	38,1	-	-	15,9	40,5	-
SUC206-19		62,0	19,0		-	38,1	-	-	15,9	-	-
SES206-19		62,0	16,0		35,7	23,8	-	-	8,0	-	44,5
UK207G2		72,0	20,0		43,0	27,0	9,0	-	-	48,0	52,0
UC306-19G2		72,0	24,0		-	43,0	-	-	17,0	44,6	-
EX306-19G2		72,0	24,0		50,0	36,5	-	17,5	17,5	-	50,0
UK307G2	80,0	25,0	43,0	33,0	9,0	-	-	48,9	52,0		
1-1/4	US206-20G2	+ H2308-20	62,0	16,0	-	30,0	-	-	8,0	40,3	-
	ES206-20G2		62,0	16,0	35,7	23,8	-	15,9	9,0	-	44,5
	UC206-20G2		62,0	19,0	-	38,1	-	-	15,9	40,3	-
	EX206-20G2		62,0	19,0	48,3	36,4	-	15,9	18,2	-	44,5
	MUC206-20FD		62,0	19,0	-	38,1	-	-	15,9	40,5	-
	MUC207-20FD		72,0	20,0	-	42,9	-	-	17,5	48,0	-
	SUC206-20		62,0	19,0	-	38,1	-	-	15,9	-	-
	SES206-20		62,0	16,0	35,7	23,8	-	-	8,0	-	44,5
	UK208G2		80,0	21,0	46,0	29,0	10,0	-	-	53,0	58,0
	UC307-20G2		80,0	25,0	-	48,0	-	-	19,0	48,9	-



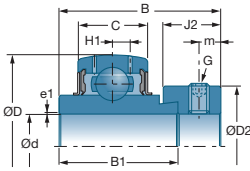

■ Bearing-inserts for self-aligning bearings unit (inch) (continued)

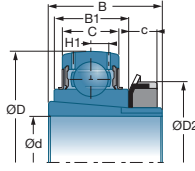

EX

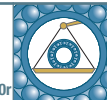

UK + H

	Adapter sleeve	H1	m	G	a*	e1	 10°N	 10°N	
References		mm	mm		mm	mm	10°N	10°N	kg
US205-16G2	+ H2306-16	4,3	5,5	1/4-28UNF	1/8	0,6	14,00	7,88	0,160
ES205-16G2		4,3	5,0	1/4-28UNF	1/8	0,6	14,00	7,88	0,180
UC205-16G2		4,3	5,5	1/4-28UNF	1/8	0,6	14,00	7,88	0,200
EX205-16G2		4,3	5,0	1/4-28UNF	1/8	0,6	14,00	7,88	0,240
MUC205-16FD		-	5,0	-	3 mm	1,5	11,90	6,30	0,181
SUC205-16		-	5,0	M6x1	3 mm	15,3	11,00	8,00	0,200
SES205-16		-	5,0	M6x1	3 mm	0,5	11,00	8,00	0,200
UK206G2		5,0	-	-	-	-	19,50	11,20	0,360
UC305-16G2		6,2	6,0	1/4-28UNF	1/8	1,5	22,36	11,50	0,340
EX305-16G2		6,2	6,0	5/16-24UNF	5/32	1,5	22,36	11,50	0,430
UK306G2	+ H2306-16	6,5	-	-	-	27,00	15,20	0,570	
US206-18G2	+ H2307-18	5,0	6,0	1/4-28UNF	1/8	0,6	19,50	11,20	0,280
ES206-18G2		5,0	6,0	5/16-24UNF	5/32	0,6	19,50	11,20	0,350
UC206-18G2		5,0	5,5	1/4-28UNF	1/8	0,6	19,50	11,20	0,340
EX206-18G2		5,0	6,0	5/16-24UNF	5/32	0,6	19,50	11,20	0,430
MUC206-18FD		-	5,0	-	3 mm	1,5	16,70	9,00	0,308
UK207G2		5,8	-	-	-	-	25,70	15,20	0,550
UC306-18G2		6,5	6,0	1/4-28UNF	1/8	1,5	27,00	15,20	0,580
EX306-18G2		6,5	6,7	5/16-24UNF	5/32	1,5	27,00	15,20	0,710
UK307G2		+ H2307-18	7,2	-	-	-	33,50	19,20	0,930
US206-19G2		+ H2307-19	5,0	6,0	1/4-28UNF	1/8	0,6	19,50	11,20
ES206-19G2	5,0		6,0	5/16-24UNF	5/32	0,6	19,50	11,20	0,310
UC206-19G2	5,0		5,5	1/4-28UNF	1/8	0,6	19,50	11,20	0,310
EX206-19G2	5,0		6,0	5/16-24UNF	5/32	0,6	19,50	11,20	0,400
MUC206-19FD	-		5,0	-	3 mm	1,5	16,70	9,00	0,308
SUC206-19	-		5,0	M6x1	3 mm	0,5	15,30	11,50	0,320
SES206-19	-		6,0	M8x1	3 mm	0,5	15,30	11,50	0,320
UK207G2	5,8		-	-	-	-	25,70	15,20	0,530
UC306-19G2	6,5		6,0	1/4-28UNF	1/8	1,5	27,00	15,20	0,560
EX306-19G2	6,5		6,7	5/16-24UNF	5/32	1,5	27,00	15,20	0,680
UK307G2	+ H2307-19	7,2	-	-	-	33,50	19,20	0,910	
US206-20G2	+ H2308-20	5,0	6,0	1/4-28UNF	1/8	0,6	19,50	11,20	0,240
ES206-20G2		5,0	6,0	5/16-24UNF	5/32	0,6	19,50	11,20	0,280
UC206-20G2		5,0	5,5	1/4-28UNF	1/8	0,6	19,50	11,20	0,300
EX206-20G2		5,0	6,0	5/16-24UNF	5/32	0,6	19,50	11,20	0,380
MUC206-20FD		-	5,0	-	3 mm	1,5	16,70	9,00	0,308
MUC207-20FD		-	6,0	-	4 mm	2,0	22,00	12,30	0,480
SUC206-20		-	5,0	M6x1	3 mm	0,5	15,30	11,50	0,320
SES206-20		-	6,0	M8x1	3 mm	0,5	15,30	11,50	0,320
UK208G2		6,3	-	-	-	-	29,60	18,20	0,760
UC307-20G2		7,2	8,0	5/16-24UNF	5/32	2,0	33,50	19,20	0,770

* Hex set-screw

Bearing-inserts (continued)

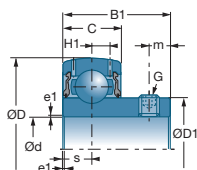

US

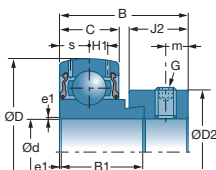

ES - SES

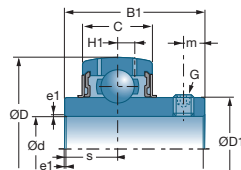

UC - SUC - MUC

d		Adapter sleeve	D	C	B	B1	c	J2	s	D1	D2
inch	References		mm	mm	mm	mm	mm	mm	mm	mm	mm
1-1/4	EX307-20G2 UK308G2	+ H2308-20	80,0	25,0	51,6	38,1	-	17,5	18,3	-	55,0
			90,0	28,0	46,0	35,0	10,0	-	-	56,5	58,0
1-3/8	US207-22G2 ES207-22G2 UC207-22G2 EX207-22G2 MUC207-22FD SUC207-22 SES207-22 UK208G2 UC307-22G2 EX307-22G2 UK308G2	+ H2308-22	72,0	17,0	-	32,0	-	-	8,5	48,0	-
			72,0	17,0	38,9	25,4	-	17,5	9,5	-	55,6
			72,0	20,0	-	42,9	-	-	17,5	48,0-	-
			72,0	20,0	51,1	37,6	-	17,5	18,8	-	55,6
			72,0	20,0	-	42,9	-	-	17,5	48,0	-
			72,0	20,0	-	42,9	-	-	17,5	-	-
			72,0	17,0	38,9	25,4	-	-	8,5	-	55,6
			80,0	21,0	46,0	29,0	10,0	-	-	53,0	58,0
			80,0	25,0	-	48,0	-	-	-	48,9	-
			80,0	25,0	51,6	38,1	-	17,5	18,3	-	55,0
			90,0	28,0	46,0	35,0	10,0	-	-	56,5	58,0
1-7/16	US207-23G2 ES207-23G2 UC207-23G2 EX207-23G2 MUC207-23FD SUC207-23 SES207-23 UK209G2 UC307-23G2 EX307-23G2 UK309G2	+ H2309-23	72,0	17,0	-	32,0	-	-	8,5	48,0	-
			72,0	17,0	38,9	25,4	-	17,5	9,5	-	55,6
			72,0	20,0	-	42,9	-	-	17,5	48,0	-
			72,0	20,0	51,1	37,6	-	17,5	18,8	-	55,6
			72,0	20,0	-	42,9	-	-	17,5	48,0	-
			72,0	20,0	-	42,9	-	-	17,5	-	-
			72,0	17,0	38,9	25,4	-	-	8,5	-	55,6
			85,0	22,0	50,0	30,0	11,0	-	-	57,2	65,0
			80,0	25,0	-	48,0	-	-	19,0	48,9	-
			80,0	25,0	51,6	38,1	-	17,5	18,3	-	55,0
			100,0	30,0	50,0	38,0	11,0	-	-	61,8	65,0
1-1/2	US208-24G2 ES208-24G2 UC208-24G2 EX208-24G2 MUC208-24FD SUC208-24 SES208-24 UK209G2 UC308-24G2 EX308-24G2 UK309G2	+ H2309-24	80,0	18,0	-	34,0	-	-	9,0	53,0	-
			80,0	18,0	43,7	30,2	-	18,3	11,0	-	60,3
			80,0	21,0	-	49,2	-	-	19,0	53,0	-
			80,0	21,0	56,3	42,8	-	18,3	21,4	-	60,3
			80,0	21,0	-	49,2	-	-	19,0	53,0	-
			80,0	21,0	-	49,2	-	-	19,0	-	-
			80,0	18,0	43,7	30,2	-	-	9,0	-	60,3
			85,0	22,0	50,0	30,0	11,0	-	-	57,2	65,0
			90,0	28,0	-	52,0	-	-	19,0	56,5	-
			90,0	28,0	57,1	41,3	-	20,6	19,8	-	63,5
			100,0	30,0	50,0	38,0	11,0	-	-	61,8	65,0
1-5/8	US209-26G2 ES209-26G2 UC209-26G2 EX209-26G2 UK210G2	+ H2310-26	85,0	19,0	-	41,2	-	-	10,2	57,2	-
			85,0	19,0	43,7	30,2	-	18,3	11,0	-	63,5
			85,0	22,0	-	49,2	-	-	19,0	57,2	-
			85,0	22,0	56,3	42,8	-	18,3	21,4	-	63,5
			90,0	23,0	55,0	31,0	12,0	-	-	61,8	70,0





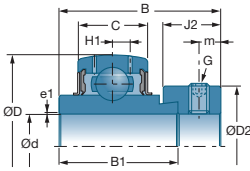

■ Bearing-inserts for self-aligning bearings unit (inch) (continued)

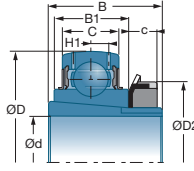

EX



UK + H

	Adapter sleeve	H1	m	G	a*	e1			
References		mm	mm		mm	mm	10°N	10°N	kg
EX307-20G2 UK308G2	+ H2308-20	7,2 8,5	6,7 -	5/16-24UNF -	5/32 -	2,0 -	33,50 40,56	19,20 24,00	0,860 1,090
US207-22G2 ES207-22G2 UC207-22G2 EX207-22G2 MUC207-22FD SUC207-22 SES207-22 UK208G2 UC307-22G2 EX307-22G2 UK308G2	+ H2308-22	5,7 5,7 5,8 5,8 - - - 6,3 7,2 7,2 8,5	6,5 6,5 6,5 6,5 6,0 6,0 6,5 - 8,0 6,7 -	1/4-28UNF 5/16-24UNF 5/16-24UNF 5/16-24UNF - M8x1 M8x1 - 5/16-24UNF 5/16-24UNF -	5/32 5/32 5/32 5/32 4 mm 4 mm 4 mm - 5/32 5/32 -	0,6 1,1 1,1 1,1 2,0 1,0 1,0 - 2,0 2,0 -	25,70 25,70 25,70 25,70 22,00 20,10 20,10 29,60 33,50 33,50 40,56	15,20 15,20 15,20 15,20 12,30 15,60 15,60 18,20 19,20 19,20 24,00	0,380 0,510 0,480 0,610 0,480 0,470 0,510 0,740 0,710 0,800 1,090
US207-23G2 ES207-23G2 UC207-23G2 EX207-23G2 MUC207-23FD SUC207-23 SES207-23 UK209G2 UC307-23G2 EX307-23G2 UK309G2	+ H2309-23	5,7 5,7 5,8 5,8 - - - 6,8 7,2 7,2 9,0	6,5 6,5 6,5 6,5 6,0 6,0 6,5 - 8,0 6,7 -	1/4-28UNF 5/16-24UNF 5/16-24UNF 5/16-24UNF - M8x1 M8x1 - 5/16-24UNF 5/16-24UNF -	5/32 5/32 5/32 5/32 4 mm 4 mm 4 mm - 5/32 5/32 -	0,6 1,1 1,1 1,1 2,0 1,0 1,0 - 2,0 2,0 -	25,70 25,70 25,70 25,70 22,00 20,10 20,10 31,85 33,50 33,50 53,00	15,20 15,20 15,20 15,20 12,30 15,60 15,60 20,80 19,20 19,20 31,80	0,370 0,480 0,450 0,580 0,480 0,470 0,510 0,800 0,700 0,780 1,460
US208-24G2 ES208-24G2 UC208-24G2 EX208-24G2 MUC208-24FD SUC208-24 SES208-24 UK209G2 UC308-24G2 EX308-24G2 UK309G2	+ H2309-24	6,2 6,2 6,3 6,3 - - - 6,8 8,5 8,5 9,0	7,0 6,5 8,0 8,0 6,0 8,0 6,5 - 10,0 8,0 -	5/16-24UNF 5/16-24UNF 5/16-24UNF 5/16-24UNF - M8x1 M8x1 - 3/8-24UNF 3/8-24UNF -	5/32 5/32 5/32 5/32 4 mm 4 mm 4 mm - 3/16 3/16 -	1,1 1,1 1,1 1,1 2,0 1,0 1,0 - 2,0 2,0 -	29,60 29,60 29,60 29,60 24,90 22,80 22,80 31,85 40,56 40,56 53,00	18,20 18,20 18,20 18,20 14,30 18,20 18,20 20,80 24,00 24,00 31,80	0,600 0,680 0,680 0,830 0,621 0,630 0,640 0,840 1,000 1,130 1,500
US209-26G2 ES209-26G2 UC209-26G2 EX209-26G2 UK210G2	+ H2310-26	6,5 6,5 6,8 6,8 6,5	8,2 6,5 8,0 6,5 -	5/16-24UNF 5/16-24UNF 5/16-24UNF 5/16-24UNF -	5/32 5/32 5/32 5/32 -	1,1 1,1 1,1 1,1 -	31,85 31,85 31,85 31,85 35,10	20,80 20,80 20,80 20,80 23,20	0,750 0,820 0,780 0,960 1,000

* Hex set-screw

Bearing-inserts (continued)

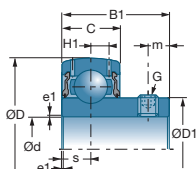

US

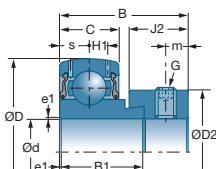

ES - SES

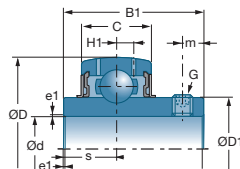

UC - SUC - MUC

d		Adapter sleeve	D	C	B	B1	c	J2	s	D1	D2
inch	References		mm	mm	mm	mm	mm	mm	mm	mm	mm
1-5/8	UC309-26G2	+ H2310-26	100,0	30,0	-	57,0	-	-	22,0	61,8	-
	EX309-26G2		100,0	30,0	58,7	42,9	-	20,6	19,8	-	70,0
	UK310G2		110,0	32,0	55,0	40,0	12,0	-	-	68,7	70,0
1-11/16	US209-27G2	+ H2310-27	85,0	19,0	-	41,2	-	-	10,2	57,2	-
	ES209-27G2		85,0	19,0	43,7	30,2	-	18,3	11,0	-	63,5
	UC209-27G2		85,0	22,0	-	49,2	-	-	19,0	57,2	-
	EX209-27G2		85,0	22,0	56,3	42,8	-	18,3	21,4	-	63,5
	UK210G2		90,0	23,0	55,0	31,0	12,0	-	-	61,8	70,0
	UC309-27G2		100,0	30,0	-	57,0	-	-	22,0	61,8	-
	EX309-27G2		100,0	30,0	58,7	42,9	-	20,6	19,8	-	70,0
	UK310G2		110,0	32,0	55,0	40,0	12,0	-	-	68,7	70,0
1-3/4	US209-28G2	+ H2310-28	85,0	19,0	-	41,2	-	-	10,2	57,2	-
	ES209-28G2		85,0	19,0	43,7	30,2	-	18,3	11,0	-	63,5
	UC209-28G2		85,0	22,0	-	49,2	-	-	19,0	57,2	-
	EX209-28G2		85,0	22,0	56,3	42,8	-	18,3	21,4	-	63,5
	SUC209-28		85,0	22,0	-	49,2	-	-	19,0	-	-
	SES209-28		85,0	19,0	43,7	30,2	-	-	9,5	-	63,5
	UK210G2		90,0	23,0	55,0	31,0	12,0	-	-	61,8	70,0
	UC309-28G2		100,0	30,0	-	57,0	-	-	22,0	61,8	-
	EX309-28G2		100,0	30,0	58,7	42,9	-	20,6	19,8	-	70,0
	UK310G2		110,0	32,0	55,0	40,0	12,0	-	-	68,7	70,0
	1-7/8		US210-30G2	+ H2311-30	90,0	20,0	-	43,5	-	-	10,9
ES210-30G2		90,0	20,0		43,7	30,2	-	18,3	11,0	-	69,9
UC210-30G2		90,0	23,0		-	51,6	-	-	19,0	61,8	-
EX210-30G2		90,0	23,0		62,7	49,2	-	18,3	24,6	-	69,9
UK211G2		100,0	25,0		59,0	33,0	12,5	-	-	69,0	75,0
UC310-30G2		110,0	32,0		-	61,0	-	-	22,0	68,7	-
EX310-30G2		110,0	32,0		66,6	49,2	-	22,2	24,6	-	76,2
UK311G2		120,0	34,0		59,0	43,0	12,5	-	-	74,9	75,0
1-15/16	US210-31G2	+ H2311-31	90,0	20,0	-	43,5	-	-	10,9	61,8	-
	ES210-31G2		90,0	20,0	43,7	30,2	-	18,3	11,0	-	69,9
	UC210-31G2		90,0	23,0	-	51,6	-	-	19,0	61,8	-
	EX210-31G2		90,0	23,0	62,7	49,2	-	18,3	24,6	-	69,9
	SUC210-31		90,0	24,0	-	51,6	-	-	19,0	-	-
	SES210-31		90,0	20,0	43,7	30,2	-	-	10,0	-	69,9
	UK211G2		100,0	25,0	59,0	33,0	12,5	-	-	69,0	75,0
	UC310-31G2		110,0	32,0	-	61,0	-	-	22,0	68,7	-
	EX310-31G2		110,0	32,0	66,6	49,2	-	22,2	24,6	-	76,2
	UK311G2		120,0	34,0	59,0	43,0	12,5	-	-	74,9	75,0





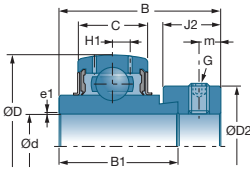

■ Bearing-inserts for self-aligning bearings unit (inch) (continued)

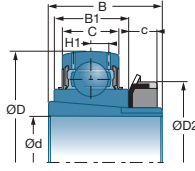

EX



UK + H

	Adapter sleeve	H1	m	G	a*	e1	 Cr	 C _{Or}	
References		mm	mm		mm	mm	10°N	10°N	kg
UC309-26G2	+ H2310-26	9,0	10,0	3/8-24UNF	3/16	2,0	53,00	31,80	1,360
EX309-26G2		9,0	8,0	3/8-24UNF	3/16	2,0	53,00	31,80	1,570
UK310G2		9,9	-	-	-	-	62,00	37,80	1,680
US209-27G2	+ H2310-27	6,5	8,2	5/16-24UNF	5/32	1,1	31,85	20,80	0,720
ES209-27G2		6,5	6,5	5/16-24UNF	5/32	1,1	31,85	20,80	0,760
UC209-27G2		6,8	8,0	5/16-24UNF	5/32	1,1	31,85	20,80	0,740
EX209-27G2	+ H2310-27	6,8	6,5	5/16-24UNF	5/32	1,1	31,85	20,80	0,910
UK210G2		6,5	-	-	-	-	35,10	23,20	0,990
UC309-27G2		9,0	10,0	3/8-24UNF	3/16	2,0	53,00	31,80	1,330
EX309-27G2	+ H2310-27	9,0	8,0	3/8-24UNF	3/16	2,0	53,00	31,80	1,520
UK310G2		9,9	-	-	-	-	62,00	37,80	1,780
US209-28G2		+ H2310-28	6,5	8,2	5/16-24UNF	5/32	1,1	31,85	20,80
ES209-28G2	6,5		6,5	5/16-24UNF	5/32	1,1	31,85	20,80	0,730
UC209-28G2	6,8		8,0	5/16-24UNF	5/32	1,1	31,85	20,80	0,700
EX209-28G2	+ H2310-28	6,8	6,5	5/16-24UNF	5/32	1,1	31,85	20,80	0,870
SUC209-28		-	8,0	M10x1,25	5 mm	1,0	25,70	20,80	0,690
SES209-28		-	6,5	M8x1	4 mm	1,0	25,70	20,80	0,670
UK210G2	+ H2310-28	6,5	-	-	-	-	35,10	23,20	0,950
UC309-28G2		9,0	10,0	3/8-24UNF	3/16	2,0	53,00	31,80	1,300
EX309-28G2		9,0	8,0	3/8-24UNF	3/16	2,0	53,00	31,80	1,470
UK310G2	+ H2310-28	9,9	-	-	-	-	62,00	37,80	1,740
US210-30G2	+ H2311-30	6,5	9,2	5/16-24UNF	5/32	1,1	35,10	23,20	0,800
ES210-30G2		6,5	6,5	5/16-24UNF	5/32	1,1	35,10	23,20	0,850
UC210-30G2		6,5	9,0	3/8-24UNF	3/16	1,1	35,10	23,20	0,870
EX210-30G2	+ H2311-30	6,5	6,5	5/16-24UNF	5/32	1,1	35,10	23,20	1,100
UK211G2		7,2	-	-	-	-	43,55	29,20	1,200
UC310-30G2		9,9	12,0	7/16-20UNF	7/32	2,0	62,00	37,80	1,740
EX310-30G2	+ H2311-30	9,9	8,7	3/8-24UNF	3/16	2,0	62,00	37,80	1,930
UK311G2		10,6	-	-	-	-	71,50	44,80	2,210
US210-31G2		+ H2311-31	6,5	9,2	5/16-24UNF	5/32	1,1	35,10	23,20
ES210-31G2	6,5		6,5	5/16-24UNF	5/32	1,1	35,10	23,20	0,830
UC210-31G2	6,5		9,0	3/8-24UNF	3/16	1,1	35,10	23,20	0,820
EX210-31G2	+ H2311-31	6,5	6,5	5/16-24UNF	5/32	1,1	35,10	23,20	1,040
SUC210-31		-	10,0	M10x1,25	5 mm	1,0	27,50	23,70	0,770
SES210-31		-	6,5	M8x1	4 mm	1,0	27,50	23,70	0,750
UK211G2	+ H2311-31	7,2	-	-	-	-	43,55	29,20	1,190
UC310-31G2		9,9	12,0	7/16-20UNF	7/32	2,0	62,00	37,80	1,680
EX310-31G2		9,9	8,7	3/8-24UNF	3/16	2,0	62,00	37,80	1,880
UK311G2	+ H2311-31	10,6	-	-	-	-	71,50	44,80	2,200

* Hex set-screw

Bearing-inserts (continued)

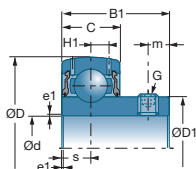

US

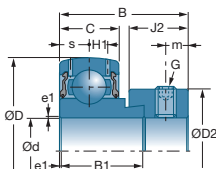

ES - SES

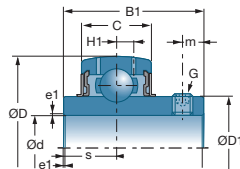

UC - SUC - MUC

d		Adapter sleeve	D	C	B	B1	c	J2	s	D1	D2	
inch	References		mm	mm	mm	mm	mm	mm	mm	mm	mm	
2	US211-32G2	+ H2311-32	100,0	23,0	-	45,3	-	-	11,8	69,0	-	
	ES211-32G2		100,0	24,0	48,4	32,5	-	20,7	12,0	-	76,2	
	UC211-32G2		100,0	25,0	-	55,6	-	-	22,2	69,0	-	
	EX211-32G2		100,0	25,0	71,3	55,4	-	20,7	27,7	-	76,2	
	SUC211-32		100,0	25,0	-	55,6	-	-	22,2	-	-	
	SES211-32		100,0	21,0	48,4	32,5	-	-	10,5	-	76,2	
	UK211G2		100,0	25,0	59,0	33,0	12,5	-	-	69,0	75,0	
	UC311-32G2		120,0	34,0	-	66,0	-	-	25,0	74,9	-	
	EX311-32G2		120,0	34,0	73,0	55,6	-	22,2	27,8	-	83,0	
UK311G2	+ H2311-32	120,0	34,0	59,0	43,0	12,5	-	-	74,9	75,0		
2-3/16	US211-35G2	+ H2313-35	100,0	23,0	-	45,3	-	-	11,8	69,0	-	
	ES211-35G2		100,0	24,0	48,4	32,5	-	20,7	12,0	-	76,2	
	UC211-35G2		100,0	25,0	-	55,6	-	-	22,2	69,0	-	
	EX211-35G2		100,0	25,0	71,3	55,4	-	20,7	27,7	-	76,2	
	SUC211-35		100,0	25,0	-	55,6	-	-	22,2	-	-	
	UK213G2		120,0	28,0	65,0	36,0	14,0	-	-	82,0	85,0	
	UC311-35G2		120,0	34,0	-	66,0	-	-	25,0	74,9	-	
	EX311-35G2		120,0	34,0	73,0	55,6	-	22,2	27,8	-	83,0	
	UK313G2		+ H2313-35	140,0	38,0	65,0	49,0	14,0	-	-	87,5	85,0
2-1/4	ES212-36G2	+ H2313-36	110,0	24,0	49,3	33,4	-	22,3	12,0	-	84,2	
	US212-36G2		110,0	24,0	-	53,7	-	-	14,9	74,9	-	
	UC212-36G2		110,0	27,0	-	65,1	-	-	25,4	74,9	-	
	EX212-36G2		110,0	27,0	77,7	61,8	-	22,3	30,9	-	84,2	
	UK213G2		120,0	28,0	65,0	36,0	14,0	-	-	82,0	85,0	
	UC312-36G2		130,0	36,0	-	71,0	-	-	26,0	81,0	-	
	EX312-36G2		130,0	36,0	79,4	61,9	-	23,9	31,0	-	89,0	
	UK313G2		+ H2313-36	140,0	38,0	65,0	49,0	14,0	-	-	87,5	85,0
	2-7/16		ES212-39G2	+ H2315-39	110,0	24,0	49,3	33,4	-	22,3	12,0	-
US212-39G2		110,0	24,0		-	53,7	-	-	14,9	74,9	-	
UC212-39G2		110,0	27,0		-	65,1	-	-	25,4	74,9	-	
EX212-39G2		110,0	27,0		77,7	61,8	-	22,3	30,9	-	84,2	
SUC212-39		110,0	27,0		-	65,1	-	-	25,4	-	-	
UK215G2		130,0	30,0		73,0	41,0	15,0	-	-	91,5	98,0	
UC312-39G2		130,0	36,0		-	71,0	-	-	26,0	81,0	-	
EX312-39G2		130,0	36,0		79,4	61,9	-	23,9	31,0	-	89,0	
UK315G2		+ H2315-39	160,0		42,0	73,0	55,0	15,0	-	-	100,5	98,0
2-1/2	UC213-40G2	+ H2315-40	120,0	28,0	-	65,1	-	-	25,4	82,0	-	
	EX213-40G2		120,0	28,0	85,7	68,2	-	23,5	34,1	-	86,0	
	UK215G2		130,0	30,0	73,0	41,0	15,0	-	-	91,5	98,0	
	UC313-40G2		140,0	38,0	-	75,0	-	-	30,0	87,5	-	



■ Bearing-inserts for self-aligning bearings unit (inch) (continued)

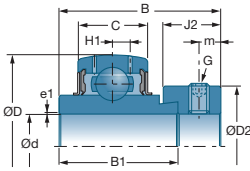

EX

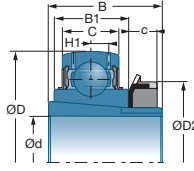

UK + H

	Adapter sleeve	H1	m	G	a*	e1				
References		mm	mm		mm	mm	10°N	10°N	kg	
US211-32G2	+ H2311-32	7,2	9,8	5/16-24UNF	5/32	1,1	43,55	29,20	1,100	
ES211-32G2		7,2	8,0	3/8-24UNF	3/16	1,1	43,55	29,20	1,180	
UC211-32G2		7,2	9,0	3/8-24UNF	3/16	1,1	43,55	29,20	1,270	
EX211-32G2		7,2	8,0	3/8-24UNF	3/16	1,5	43,55	29,20	1,580	
SUC211-32		-	10,0	M10x1,25	5 mm	1,0	34,00	25,50	1,060	
SES211-32		-	8,0	M10x1,25	5 mm	1,0	34,00	25,50	1,030	
UK211G2		-	-	-	-	-	-	43,55	29,20	1,130
UC311-32G2		10,6	12,0	7/16-20UNF	7/32	2,0	71,50	44,80	2,080	
EX311-32G2		10,6	9,0	3/8-24UNF	3/16	2,0	71,50	44,80	2,490	
UK311G2		+ H2311-32	10,6	-	-	-	-	71,50	44,80	2,140
US211-35G2	+ H2313-35	7,2	9,8	5/16-24UNF	5/32	1,1	43,55	29,20	1,050	
ES211-35G2		7,2	8,0	3/8-24UNF	3/16	1,1	43,55	29,20	0,810	
UC211-35G2		7,2	9,0	3/8-24UNF	3/16	1,1	43,55	29,20	1,100	
EX211-35G2		7,2	8,0	3/8-24UNF	3/16	1,5	43,55	29,20	1,360	
SUC211-35		-	10,0	M10x1,25	5 mm	1,0	34,00	25,50	1,060	
UK213G2		8,0	-	-	-	-	57,20	40,00	2,110	
UC311-35G2		10,6	12,0	7/16-20UNF	7/32	2,0	71,50	44,80	1,870	
EX311-35G2		10,6	9,0	3/8-24UNF	3/16	2,0	71,50	44,80	2,240	
UK313G2		+ H2313-35	12,1	-	-	-	-	93,86	60,50	3,460
ES212-36G2		+ H2313-36	8,0	8,0	3/8-24UNF	3/16	1,1	52,50	32,80	1,300
US212-36G2	8,0		9,8	3/8-24UNF	3/16	1,1	52,50	32,80	1,300	
UC212-36G2	8,2		10,5	3/8-24UNF	3/16	1,1	52,50	32,80	1,670	
EX212-36G2	8,2		8,0	3/8-24UNF	3/16	1,5	52,50	32,80	2,030	
UK213G2	8,0		-	-	-	-	57,20	40,00	2,010	
UC312-36G2	11,3		12,0	7/16-20UNF	7/32	2,0	81,60	51,80	2,650	
EX312-36G2	11,3		9,0	3/8-24UNF	3/16	2,0	81,60	51,80	2,950	
UK313G2	+ H2313-36		12,1	-	-	-	-	93,86	60,50	3,360
ES212-39G2	+ H2315-39		8,0	8,0	3/8-24UNF	3/16	1,1	52,50	32,80	1,090
US212-39G2			8,0	9,8	3/8-24UNF	3/16	1,1	52,50	32,80	1,220
UC212-39G2		8,2	10,5	3/8-24UNF	3/16	1,1	52,50	32,80	1,450	
EX212-39G2		8,2	8,0	3/8-24UNF	3/16	1,5	52,50	32,80	1,760	
SUC212-39		-	10,0	M10x1,25	5 mm	1,0	41,00	31,50	1,470	
UK215G2		9,0	-	-	-	-	66,00	49,50	2,820	
UC312-39G2		11,3	12,0	7/16-20UNF	7/32	2,0	81,60	51,80	2,500	
EX312-39G2		11,3	9,0	3/8-24UNF	3/16	2,0	81,60	51,80	2,860	
UK315G2		+ H2315-39	13,5	-	-	-	-	113,36	76,80	5,130
UC213-40G2		+ H2315-40	8,0	12,0	3/8-24UNF	3/16	1,5	57,20	40,00	1,940
EX213-40G2	8,0		8,5	3/8-24UNF	3/16	1,5	57,20	40,00	2,510	
UK215G2	9,0		-	-	-	-	66,00	49,50	2,810	
UK313-40G2	12,1		12,0	7/16-20UNF	7/32	2,0	93,86	60,50	3,300	

* Hex set-screw

Bearing-inserts (continued)

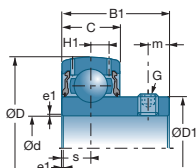

US

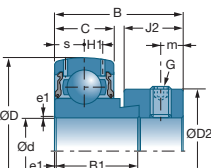

ES - SES

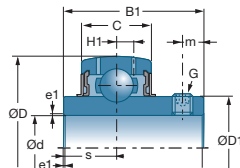

UC - SUC - MUC

d		Adapter sleeve	D	C	B	B1	c	J2	s	D1	D2
inch	References		mm	mm	mm	mm	mm	mm	mm	mm	mm
2-1/2	EX313-40G2	+ H2315-40	140,0	38,0	85,7	65,1	-	27,0	32,5	-	97,0
	UK315G2		160,0	42,0	73,0	55,0	15,0	-	-	100,5	98,0
2-11/16	UC214-43G2	+ H2316-43	125,0	30,0	-	74,6	-	-	30,2	86,5	-
	EX214-43G2		125,0	30,0	85,7	68,2	-	23,5	34,1	-	96,8
	UK216G2		140,0	33,0	78,0	44,0	17,0	-	-	98,0	105,0
	UC314-43G2	+ H2316-43	150,0	40,0	-	78,0	-	-	33,0	94,0	-
	EX314-43G2		150,0	40,0	92,1	68,3	-	30,2	34,2	-	102,0
	UK316G2		170,0	44,0	78,0	55,0	17,0	-	-	107,9	105,0
2-3/4	UC214-44G2	+ H2316-44	125,0	30,0	-	74,6	-	-	30,2	86,5	-
	EX214-44G2		125,0	30,0	85,7	68,2	-	23,5	34,1	-	96,8
	UK216G2		140,0	33,0	78,0	44,0	17,0	-	-	98,0	105,0
	UC314-44G2	+ H2316-44	150,0	40,0	-	78,0	-	-	33,0	94,0	-
	EX314-44G2		150,0	40,0	92,1	68,3	-	30,2	34,2	-	102,0
	UK316G2		170,0	44,0	78,0	55,0	17,0	-	-	107,9	105,0
2-15/16	UC215-47G2	+ H2317-47	130,0	30,0	-	77,8	-	-	33,3	91,5	-
	EX215-47G2		130,0	30,0	92,1	74,6	-	23,9	37,3	-	102,0
	UK217G2		150,0	35,0	82,0	44,0	18,0	-	-	105,1	110,0
	UC315-47G2	+ H2317-47	160,0	42,0	-	82,0	-	-	32,0	100,5	-
	EX315-47G2		160,0	42,0	100,0	74,6	-	31,8	37,3	-	113,0
	UK317G2		180,0	46,0	82,0	60,0	18,0	-	-	114,0	110,0
3	UC215-48G2	+ H2317-48	130,0	30,0	-	77,8	-	-	33,3	91,5	-
	EX215-48G2		130,0	30,0	92,1	74,6	-	23,9	37,3	-	102,0
	UK217G2		150,0	35,0	82,0	44,0	18,0	-	-	105,1	110,0
	UC315-48G2	+ H2317-48	160,0	42,0	-	82,0	-	-	32,0	100,5	-
	EX315-48G2		160,0	42,0	100,0	74,6	-	31,8	37,3	-	113,0
	UK317G2		180,0	46,0	82,0	60,0	18,0	-	-	114,0	110,0
3-1/4	EX217-52G2	+ H2319-55	150,0	35,0	73,2	53,2	-	27,0	23,4	-	119,0
	UC217-52G2		150,0	35,0	-	85,7	-	-	34,1	105,1	-
	UC317-52G2		180,0	46,0	-	96,0	-	-	40,0	114,0	-
	EX317-52G2		180,0	46,0	109,5	84,1	-	31,8	42,0	-	127,0
	UK319G2		200,0	50,0	90,0	66,0	19,0	-	-	126,5	125,0
	3-1/2		EX218-56G2	+ H2320-56	160,0	37,0	72,5	55,0	-	24,0	24,5
UC218-56G2	160,0	37,0	-		96,0	-	-	39,7	111,0	-	
UC318-56G2	190,0	48,0	-		96,0	-	-	40,0	120,0	-	
EX318-56G2	190,0	48,0	115,9		87,3	-	36,5	43,6	-	133,0	
UK320G2	215,0	54,0	97,0		68,0	20,0	-	-	134,5	130,0	





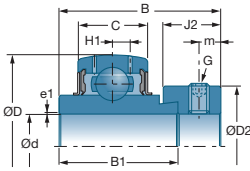

■ Bearing-inserts for self-aligning bearings unit (inch) (continued)

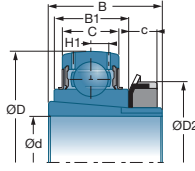

EX



UK + H

	Adapter sleeve	H1	m	G	a*	e1			
References		mm	mm		mm	mm	10°N	10°N	kg
EX313-40G2 UK315G2	+ H2315-40	12,1 13,5	11,5 -	7/16-20UNF -	7,32 -	2,0 -	93,86 113,36	60,50 76,80	3,850 5,100
UC214-43G2 EX214-43G2 UK216G2	+ H2316-43	9,0 9,0 10,3	12,0 8,5 -	3/8-24UNF 3/8-24UNF -	3/16 3/16 -	2,0 2,0 -	62,00 62,00 72,50	45,00 45,00 54,20	2,020 2,620 3,260
UC314-43G2 EX314-43G2 UK316G2	+ H2316-43	12,8 12,8 14,5	12,0 12,0 -	7/16-20UNF 7/16-20UNF -	7/32 7/32 -	2,5 2,5 -	104,26 104,26 122,85	68,00 68,00 86,50	4,000 4,450 5,850
UC214-44G2 EX214-44G2 UK216G2	+ H2316-44	9,0 9,0 10,3	12,0 8,5 -	7/16-20UNF 3/8-24UNF -	7/32 3/16 -	2,0 2,0 -	62,00 62,00 72,50	45,00 45,00 54,20	2,060 2,580 3,160
UC314-44G2 EX314-44G2 UK316G2	+ H2316-44	12,8 12,8 14,5	12,0 12,0 -	7/16-20UNF 7/16-20UNF -	7/32 7/32 -	2,5 2,5 -	104,26 104,26 122,85	68,00 68,00 86,50	3,960 4,400 5,750
UC215-47G2 EX215-47G2 UK217G2	+ H2317-47	9,0 9,0 11,0	12,0 8,5 -	7/16-20UNF 3/8-24UNF -	7/32 3/16 -	2,0 2,0 -	66,00 66,00 83,20	49,50 49,50 63,80	2,300 2,800 3,820
UC315-47G2 EX315-47G2 UK317G2	+ H2317-47	13,5 13,5 15,5	14,0 13,0 -	1/2-20UNF 1/2-20UNF -	1/4 5/16 -	2,5 2,5 -	113,36 113,36 132,60	76,80 76,80 96,50	4,290 5,400 6,840
UC215-48G2 EX215-48G2 UK217G2	+ H2317-48	9,0 9,0 11,0	12,0 8,5 -	7/16-20UNF 3/8-24UNF -	7/32 3/16 -	2,0 2,0 -	66,00 66,00 83,20	49,50 49,50 63,80	2,130 2,740 3,720
UC315-48G2 EX315-48G2 UK317G2	+ H2317-48	13,5 13,5 15,5	14,0 13,0 -	1/2-20UNF 5/8-18UNF -	1/4 5/16 -	2,5 2,5 -	113,36 113,36 132,60	76,80 76,80 96,50	4,240 5,280 6,740
EX217-52G2 UC217-52G2 UC317-52G2	+ H2319-55	11,0 11,0 15,5	10,0 14,0 16,0	7/16-20UNF 7/16-20UNF 5/8-18UNF	7/32 7/32 5/16	2,0 2,0 3,0	83,20 83,20 132,60	63,80 63,80 96,50	3,650 3,320 6,760
EX317-52G2 UK319G2	+ H2319-55	15,5 16,7	14,0 -	5/8-18UNF -	5/16 -	3,0 -	132,60 156,00	96,50 122,00	7,880 9,660
EX218-56G2 UC218-56G2 UC318-56G2	+ H2320-56	10,3 12,0 16,5	9,5 14,0 16,0	7/16-20UNF 1/2-20UNF 5/8-18UNF	7/32 7/32 5/16	2,0 2,0 3,5	96,00 96,00 143,00	71,50 71,50 108,00	5,000 4,560 8,030
EX318-56G2 UK320G2	+ H2320-56	16,5 19,0	14,5 -	3/4-16UNF -	3/8 -	3,0 -	143,00 171,60	108,00 140,00	9,200 10,620

* Hex set-screw

Bearing-inserts (continued)

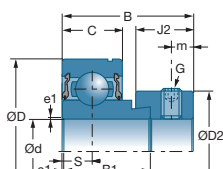

CES

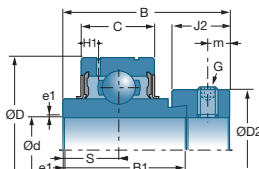

CEX

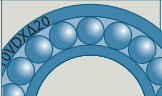
d		D	C	B	B1	J2	s	D1	D2
mm	References	mm	mm	mm	mm	mm	mm	mm	mm
20	CES 204	47,0	14,0	31,0	21,5	13,5	7,0	–	33,3
	CEX 204	47,0	17,0	43,7	34,2	13,5	17,1	–	33,3
	CUC 204	47,0	17,0	–	31,0	–	12,7	29,0	–
	CUS 204	47,0	14,0	–	25,0	–	7,0	28,3	–
25	CES 205	52,0	15,0	31,0	21,5	13,5	7,5	–	38,1
	CEX 205	52,0	17,0	44,4	34,9	13,5	17,5	–	38,1
	CUC 205	52,0	17,0	–	34,0	–	14,3	34,0	–
	CUS 205	52,0	15,0	–	27,0	–	7,5	34,0	–
30	CES 206	62,0	16,0	35,7	23,8	15,9	8,0	–	44,5
	CEX 206	62,0	19,0	48,4	36,5	15,9	18,3	–	44,5
	CUC 206	62,0	19,0	–	38,1	–	15,9	40,3	–
	CUS 206	62,0	16,0	–	30,0	–	8,0	40,0	–
35	CES 207	72,0	17,0	38,9	25,4	17,5	8,5	–	55,6
	CEX 207	72,0	20,0	51,1	37,6	17,5	18,8	–	55,6
	CUC 207	72,0	20,0	–	42,9	–	17,5	46,9	–
	CUS 207	72,0	17,0	–	32,0	–	8,5	46,9	–
40	CES 208	80,0	18,0	43,7	30,2	18,3	9,0	–	60,3
	CEX 208	80,0	21,0	56,3	42,8	18,3	21,4	–	60,3
	CUC 208	80,0	21,0	–	49,2	–	19,0	53,0	–
	CUS 208	80,0	18,0	–	34,0	–	9,0	52,4	–
45	CES 209	85,0	19,0	43,7	30,2	18,3	9,5	–	63,5
	CEX 209	85,0	22,0	56,3	42,8	18,3	21,4	–	63,5
	CUC 209	85,0	22,0	–	49,2	–	19,0	57,2	–
	CUS 209	85,0	19,0	–	41,2	–	9,5	57,6	–
50	CES 210	90,0	20,0	43,7	30,2	18,3	10,0	–	69,9
	CEX 210	90,0	24,0	62,7	49,2	18,3	24,6	–	69,9
	CUC 210	90,0	23,0	–	51,6	–	19,0	61,8	–
	CUS 210	90,0	20,0	–	43,5	–	10,0	63,2	–



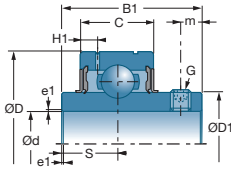

■ Bearing-inserts with cylindrical outside diameter (mm)

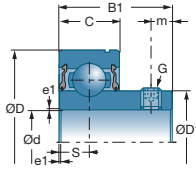

CUC



CUS

References	H1	m	G	a*	e1			
	mm	mm		mm	mm	10 ³ N	10 ³ N	kg
CES 204	–	5,0	M6x1	3	1,0	12,8	6,7	0,15
CEX 204	4,0	5,0	M6x1	3	1,0	12,8	6,7	0,22
CUC 204	4,0	4,5	M6x1	3	0,6	12,8	6,7	0,20
CUS 204	–	5,0	M6x1	3	1,0	12,8	6,7	0,13
CES 205	–	5,0	M6x1	3	1,0	14,0	7,9	0,19
CEX 205	4,1	5,0	M6x1	3	1,0	14,0	7,9	0,25
CUC 205	4,1	5,0	M6x1	3	0,6	14,0	7,9	0,21
CUS 205	–	5,0	M6x1	3	1,0	14,0	7,9	0,17
CES 206	–	6,0	M6x1	3	1,0	19,5	11,2	0,33
CEX 206	4,2	6,0	M6x1	3	1,0	19,5	11,2	0,41
CUC 206	4,2	5,5	M6x1	3	0,6	19,5	11,2	0,35
CUS 206	–	5,5	M6x1	3	1,0	19,5	11,2	0,27
CES 207	–	6,5	M8x1	4	1,5	25,7	15,2	0,50
CEX 207	5,0	6,5	M8x1	4	1,5	25,7	15,2	0,60
CUC 207	5,0	6,5	M8x1	4	1,1	25,7	15,2	0,47
CUS 207	–	6,0	M6x1	4	1,0	25,7	15,2	0,42
CES 208	–	6,5	M8x1	4	1,5	29,6	18,2	0,65
CEX 208	5,0	6,5	M8x1	4	1,5	29,6	18,2	0,78
CUC 208	5,0	8,0	M8x1	4	1,1	29,6	18,2	0,64
CUS 208	–	8,0	M8x1	4	1,0	31,9	20,8	0,48
CES 209	–	6,5	M8x1	4	1,5	31,9	20,8	0,69
CEX 209	5,1	6,5	M8x1	4	1,5	31,9	20,8	0,87
CUC 209	5,1	8,0	M8x1	4	1,1	31,9	20,8	0,68
CUS 209	–	8,0	M8x1	4	1,5	31,9	20,8	0,57
CES 210	–	6,5	M8x1	4	1,5	35,1	23,2	0,80
CEX 210	5,6	6,5	M8x1	4	1,5	35,1	23,2	1,01
CUC 210	5,6	9,0	M10x1,25	5	1,1	35,1	23,2	0,80
CUS 210	–	9,0	M8x1	4	1,5	35,1	23,2	0,66

* Hex set-screw

Bearing-inserts (continued)

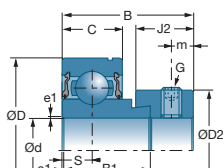

CES

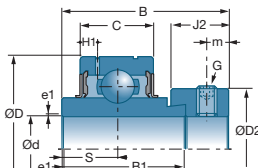

CEX

d		D	C	B	B1	J2	s	D1	D2
inch	References	mm	mm	mm	mm	mm	mm	mm	mm
3/4	CES 204-12	47	14	31	21,5	13,5	7	–	33,3
	CEX 204-12	47	17	43,7	34,2	13,5	17,1	–	33,3
	CUC 204-12	47	17	–	31	–	12,7	29	–
	CUS 204-12	47	14	–	25	–	7	28,3	–
7/8	CES 205-14	52	15	31	21,5	13,5	7,5	–	38,1
	CEX 205-14	52	17	44,4	34,9	13,5	17,5	–	38,1
	CUC 205-14	52	17	–	34	–	14,3	34	–
	CUS 205-14	52	15	–	27	–	7,5	34	–
15/16	CES 205-15	52	15	31	21,5	13,5	7,5	–	38,1
	CEX 205-15	52	17	44,4	34,9	13,5	17,5	–	38,1
	CUC 205-15	52	17	–	34	–	14,3	34	–
	CUS 205-15	52	15	–	27	–	7,5	34	–
1	CES 205-16	52	15	31	21,5	13,5	7,5	–	38,1
	CEX 205-16	52	17	44,4	34,9	13,5	17,5	–	38,1
	CUC 205-16	52	17	–	34	–	14,3	34	–
	CUS 205-16	52	15	–	27	–	7,5	34	–
1-1/8	CES 206-18	62	16	35,7	23,8	15,9	8	–	44,5
	CEX 206-18	62	19	48,4	36,5	15,9	18,3	–	44,5
	CUC 206-18	62	19	–	38,1	–	15,9	40,3	–
	CUS 206-18	62	16	–	30	–	8	40	–
1-3/16	CES 206-19	62	16	35,7	23,8	15,9	8	–	44,5
	CEX 206-19	62	19	48,4	36,5	15,9	18,3	–	44,5
	CUC 206-19	62	19	–	38,1	–	15,9	40,3	–
	CUS 206-19	62	16	–	30	–	8	40	–
1-1/4	CES 206-20	62	16	35,7	23,8	15,9	8	–	44,5
	CEX 206-20	62	19	48,4	36,5	15,9	18,3	–	44,5
	CUC 206-20	62	19	–	38,1	–	15,9	40,3	–
	CUS 206-20	62	16	–	30	–	8	40	–
1-3/8	CES 207-22	72	17	38,9	25,4	17,5	8,5	–	55,6
	CEX 207-22	72	20	51,1	37,6	17,5	18,8	–	55,5
	CUC 207-22	72	20	–	42,9	–	17,5	46,9	–
	CUS 207-22	72	17	–	32	–	8,5	46,9	–



■ Bearing-inserts with cylindrical outside diameter (inch)

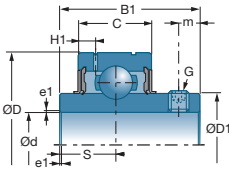

CUC

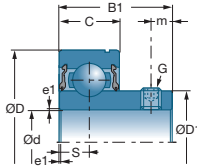

CUS

 References	H1	m	G	a*	e1	 10 ³ N	 10 ³ N	 kg
	mm	mm		inch	mm	10 ³ N	10 ³ N	kg
CES 204-12	–	5	1/4-28UNF	1/8	1,0	12,8	6,65	0,15
CEX 204-12	4	5	1/4-28UNF	1/8	1,0	12,8	6,65	0,22
CUC 204-12	4	4,5	1/4-28UNF	1/8	0,6	12,8	6,65	0,20
CUS 204-12	–	5	1/4-28UNF	1/8	1,0	12,8	6,65	0,13
CES 205-14	–	5	1/4-28UNF	1/8	1,0	14,0	7,88	0,19
CEX 205-14	4,1	5	1/4-28UNF	1/8	1,0	14,0	7,88	0,25
CUC 205-14	4,1	5	1/4-28UNF	1/8	0,6	14,0	7,88	0,21
CUS 205-14	–	5	1/4-28UNF	1/8	1,0	14,0	7,88	0,18
CES 205-15	–	5	1/4-28UNF	1/8	1,0	14,0	7,88	0,19
CEX 205-15	4,1	5	1/4-28UNF	1/8	1,0	14,0	7,88	0,25
CUC 205-15	4,1	5	1/4-28UNF	1/8	0,6	14,0	7,88	0,21
CUS 205-15	–	5	1/4-28UNF	1/8	1,0	14,0	7,88	0,18
CES 205-16	–	5	1/4-28UNF	1/8	1,0	14,0	7,88	0,18
CEX 205-16	4,1	5	1/4-28UNF	1/8	1,0	14,0	7,88	0,24
CUC 205-16	4,1	5	1/4-28UNF	1/8	0,6	14,0	7,88	0,21
CUS 205-16	–	5	1/4-28UNF	1/8	1,0	14,0	7,88	0,18
CES 206-18	–	6	5/16-24UNF	5/32	1,0	19,5	11,2	0,35
CEX 206-18	4,2	6	5/16-24UNF	5/32	1,0	19,5	11,2	0,43
CUC 206-18	4,2	5,5	1/4-28UNF	1/8	0,6	19,5	11,2	0,34
CUS 206-18	–	5,5	1/4-28UNF	1/8	1,0	19,5	11,2	0,28
CES 206-19	–	6	5/16-24UNF	5/32	1,0	19,5	11,2	0,31
CEX 206-19	4,2	6	5/16-24UNF	5/32	1,0	19,5	11,2	0,40
CUC 206-19	4,2	5,5	1/4-28UNF	1/8	0,6	19,5	11,2	0,31
CUS 206-19	–	5,5	1/4-28UNF	1/8	1,0	19,5	11,2	0,25
CES 206-20	–	6	5/16-24UNF	5/32	1,0	19,5	11,2	0,28
CEX 206-20	4,2	6	5/16-24UNF	5/32	1,0	19,5	11,2	0,38
CUC 206-20	4,2	5,5	1/4-28UNF	1/8	0,6	19,5	11,2	0,30
CUS 206-20	–	5,5	1/4-28UNF	1/8	1,0	19,5	11,2	0,24
CES 207-22	–	6,5	5/16-24UNF	5/32	1,5	25,7	15,2	0,51
CEX 207-22	5	6,5	5/16-24UNF	5/32	1,5	25,7	15,2	0,61
CUC 207-22	5	6,5	5/16-24UNF	5/32	1,1	25,7	15,2	0,48
CUS 207-22	–	6	1/4-28UNF	1/8	1,0	25,7	15,2	0,38

* Hex set-screw

Bearing-inserts (continued)

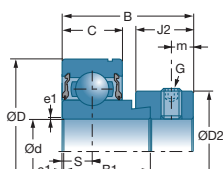

CES

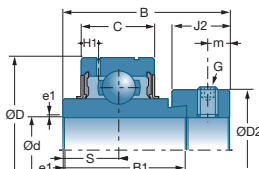

CEX

d		D	C	B	B1	J2	s	D1	D2
inch	References	mm	mm	mm	mm	mm	mm	mm	mm
1-7/16	CES 207-23	72	17	38,9	25,4	17,5	8,5	–	55,6
	CEX 207-23	72	20	51,1	37,6	17,5	18,8	–	–
	CUC 207-23	72	20	–	42,9	–	17,5	46,9	55,5
	CUS 207-23	72	17	–	32	–	8,5	46,9	–
1-1/2	CES 208-24	80	18	43,7	30,2	18,3	9	–	60,3
	CEX 208-24	80	21	56,3	42,8	18,3	21,4	–	60,3
	CUC 208-24	80	21	–	49,2	–	19	53	–
	CUS 208-24	80	18	–	34	–	9	52,4	–
1-5/8	CES 209-26	85	19	43,7	30,2	18,3	9,5	–	63,5
	CEX 209-26	85	22	56,3	42,8	18,3	21,4	–	63,5
	CUC 209-26	85	22	–	49,2	–	19	57,2	–
	CUS 209-26	85	19	–	41,2	–	9,5	57,6	–
1-11/16	CES 209-27	85	19	43,7	30,2	18,3	9,5	–	63,5
	CEX 209-27	85	22	56,3	42,8	18,3	21,4	–	63,5
	CUC 209-27	85	22	–	49,2	–	19	57,2	–
	CUS 209-27	85	19	–	41,2	–	9,5	57,6	–
1-3/4	CES 209-28	85	19	43,7	30,2	18,3	9,5	–	63,5
	CEX 209-28	85	22	56,3	42,8	18,3	21,4	–	63,5
	CUC 209-28	85	22	–	49,2	–	19	57,2	–
	CUS 209-28	85	19	–	41,2	–	9,5	57,6	–
1-7/8	CES 210-30	90	20	43,7	30,2	18,3	10	–	69,9
	CEX 210-30	90	24	62,7	49,2	18,3	24,6	–	69,5
	CUC 210-30	90	23	–	51,6	–	19	61,8	–
	CUS 210-30	90	20	–	43,5	–	10	63,2	–
1-15/16	CES 210-31	90	20	43,7	30,2	18,3	10	–	69,9
	CEX 210-31	90	24	62,7	49,2	18,3	24,6	–	69,5
	CUC 210-31	90	23	–	51,6	–	19	61,8	–
	CUS 210-31	90	20	–	43,5	–	10	63,2	–





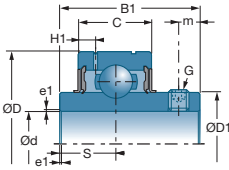

■ Bearing-inserts with cylindrical outside diameter (inch) (continued)

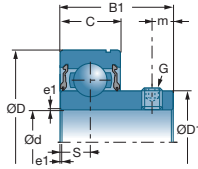

CUC



CUS

	H1	m	G	a*	e1			
	References	mm	mm	inch	mm	10 ³ N	10 ³ N	kg
CES 207-23	–	6,5	5/16-24UNF	5/32	1,5	25,7	15,2	0,48
CEX 207-23	5	6,5	5/16-24UNF	5/32	1,5	25,7	15,2	0,58
CUC 207-23	5	6,5	5/16-24UNF	5/32	1,1	25,7	15,2	0,45
CUS 207-23	–	6	1/4-28UNF	1/8	1,0	25,7	15,2	0,37
CES 208-24	–	6,5	5/16-24UNF	5/32	1,5	29,6	18,2	0,68
CEX 208-24	5	6,5	5/16-24UNF	5/32	1,5	29,6	18,2	0,83
CUC 208-24	5	8	5/16-24UNF	5/32	1,1	29,6	18,2	0,68
CUS 208-24	–	8	5/16-24UNF	5/32	1,0	29,6	18,2	0,60
CES 209-26	–	6,5	5/16-24UNF	5/32	1,5	31,85	20,8	0,82
CEX 209-26	5,1	6,5	5/16-24UNF	5/32	1,5	31,85	20,8	0,96
CUC 209-26	5,1	8	5/16-24UNF	5/32	1,1	31,85	20,8	0,78
CUS 209-26	–	8	5/16-24UNF	5/32	1,5	31,85	20,8	0,75
CES 209-27	–	6,5	5/16-24UNF	5/32	1,5	31,85	20,8	0,76
CEX 209-27	5,1	6,5	5/16-24UNF	5/32	1,5	31,85	20,8	0,91
CUC 209-27	5,1	8	5/16-24UNF	5/32	1,1	31,85	20,8	0,74
CUS 209-27	–	8	5/16-24UNF	5/32	1,5	31,85	20,8	0,72
CES 209-28	–	6,5	5/16-24UNF	5/32	1,5	31,85	20,8	0,73
CEX 209-28	5,1	6,5	5/16-24UNF	5/32	1,5	31,85	20,8	0,87
CUC 209-28	5,1	8	5/16-24UNF	5/32	1,1	31,85	20,8	0,70
CUS 209-28	–	8	5/16-24UNF	5/32	1,5	31,85	20,8	0,67
CES 210-30	–	6,5	5/16-24UNF	5/32	1,5	35,1	23,2	0,85
CEX 210-30	5,6	6,5	5/16-24UNF	5/32	1,5	35,1	23,2	1,10
CUC 210-30	5,6	9	3/8-24UNF	3/16	1,1	35,1	23,2	0,80
CUS 210-30	–	9	5/16-24UNF	5/32	1,5	35,1	23,2	0,80
CES 210-31	–	6,5	5/16-24UNF	5/32	1,5	35,1	23,2	0,83
CEX 210-31	5,6	6,5	5/16-24UNF	5/32	1,5	35,1	23,2	1,04
CUC 210-31	5,6	9	3/8-24UNF	3/17	1,1	35,1	23,2	0,82
CUS 210-31	–	9	5/16-24UNF	5/32	1,5	35,1	23,2	0,78

* Hex set-screw



Single-row angular-contact ball bearings

Single-row angular-contact ball bearings 232

■ Definition and capabilities	232
■ Series	233
■ Variants	233
■ Tolerances and clearance	234
■ Design criteria	236
■ Characteristics	238

4-points angular-contact bearings 244

■ Definition and capabilities	244
■ Series	244
■ Tolerances and clearance	245
■ Design criteria	245
■ Installation/assembly criteria	245
■ Suffixes	245
■ Characteristics	246

Angular-contact bearings high precision MachLine® Range 248

■ Definition and capabilities	248
■ Series	248
■ Design criteria	249
■ Characteristics	250
<i>MachLine, high precision standard bearing for machine tools</i>	250
<i>MachLine, high speed precision for machine tools</i>	256

Single-row angular-contact ball bearings

Definition and capabilities

Always mounted in opposition to another bearing of same type, they offer high mounting stiffness, especially when preloaded.

→ Definition

■ Cage

Standard dimension bearings are equipped with either a metal cage or a synthetic material cage. In the latter case the maximum continuous operating temperature is 120°C or 248°F (150°C peak or 302°F peak).

Large-sized bearings are equipped with a machined brass cage.

■ Contact angle

Angular-contact ball bearings of normal precision have a contact angle of 40° (suffix B). Some bearings have a contact angle of 30°, in which case the bearing reference does not have the B suffix.

→ Capabilities

■ Load and speed

These bearings are designed to:

- withstand combined loads with a predominant axial component
- withstand loads in one direction only (they must be mounted in opposition with bearings of the same type)
- accept relatively high speeds of rotation

$$F_a / F_r \geq 1$$

■ Misalignment

Assembly made up of a single bearing

Slight misalignment between the shaft and housing is acceptable. The value depends on the assembly clearance: from 0.10° to 0.15° if the assembly clearance is 0.06° in the case of a preloaded assembly.

Assembly made up of two bearings

In this case, the assembly is similar to a double-row ball bearing and the acceptable misalignment values are very low, in the range of 0.06°.

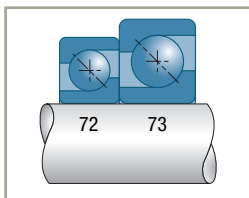

Variants

■ Bearings for universal matching (suffix BG)

The bearings in the 72 ... BG, 73 ... BG series can be assembled in pairs to form a single pillow block. They are supplied individually and can be matched in either an X, O or Tandem arrangement.

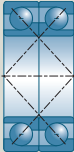
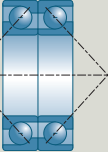
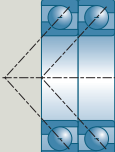
Arrangement	Characteristics
Face-to-face or X arrangement (type DF) 	<p>This arrangement constitutes a single assembly. Another bearing is needed to form the second pillow block of the shaft.</p>
Back-to-back or O arrangement (type DB) 	<p>Good rigidity under tilting torque. This assembly can in some cases ensure shaft retention on its own thanks to the distance between the load application point.</p>
Tandem (type DT) 	<p>For very high axial loads but in one direction only. This arrangement constitutes a single assembly; another bearing must be mounted in the opposite direction to form the second assembly of the shaft.</p>

Other variants can give assemblies with a greater or lesser amount of preload (suffix BGL or BGO); they requires usually a prior technical study.

On request these bearings are supplied with a maximum runout mark on the inner ring. When the two bearings are assembled, their respective markings must be aligned.

Single-row angular-contact ball bearings *(continued)*

Tolerances and clearances

■ Tolerances

Usually manufactured in the normal tolerance class.

Single-row ball bearings can be supplied on request with all or specified characteristics in tolerance classes 6 and 5 (e.g. bore or axial run-out in tolerance class 6).

■ Axial clearance on assembly with two separate bearings

These bearings are always assembled in opposition, and their internal clearance is determined by adjusting the axial clearance of the shaft at the time of assembly.

For information, the relationship between the axial clearance and the radial clearance is given by the formula:

$$J_r = 0.83 J_a$$

These bearings can be installed preloaded if needed to increase the axial rigidity of an assembly. The maximum speed of rotation is then reduced, and depends on the value of the preload. Consult SNR.

The aim of adjusting an assembly comprising two angular-contact ball bearings is to adjust the axial clearance, that is to say the initial relative position of the inner rings with respect to the outer rings, so that the bearings are positioned in the best possible operating conditions, while at the same time satisfying the specific assembly requirements (precision of rotation, rigidity, vibration, heating, etc.). The adjustment is defined either by an axial clearance or a preload.

The optimum preload of an assembly is determined according to the application specifications (rigidity, precision, temperature, vibration, etc.). Whatever the case, consult SNR.

The assembly and adjustment conditions affect the clearance of the assembly. Type BG bearings usually have reduced residual clearance after assembly.

■ Axial clearance of a BG assembly

The clearance of an assembly (X or O arrangement) is defined by the protrusion d_e of one ring with respect to the other.

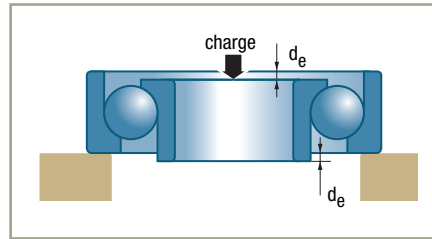

Bearing bore		Protusion value in μm
from	to	
10	30	8 - 19
35	50	8 - 20
55	80	11 - 23
85	110	17 - 29
115	180	20 - 32

The axial clearance of the assembly is calculated as follows:

- mean theoretical axial clearance:

$$2 d_e$$

- radial reduction of clearance due to interference fits:

$$\Delta J_r$$

- mean axial clearance of the assembly:

$$J_a = 2 d_e - (\Delta J_r / 0.83)$$

By applying this formula to the calculation of probable tolerances, one obtains a minimum clearance value close to zero with a conventional assembly (interference fit on shaft with a $j6/k6$ tolerance and clearance fit in the housing with an $H7/J7$ tolerance).

Single-row angular-contact ball bearings *(continued)*

Design criteria

■ Bearing life

■ Shaft mounted on two single bearings

Equivalent dynamic load

The axial equilibrium of the shaft depends not only on the external forces applied to it, but also on the forces induced by the radial loads applied to each bearing.

Equivalent static load

Its value P_0 is the greater of the two values obtained using the following formula:

$$P_0 = F_r$$

$$P_0 = 0.5 F_r + 0.26 F_a$$

■ Shaft with one of its two assemblies made up of two matched bearings in the 72...BG or 73...BG series

This assembly is considered as being made up of a single double-row ball bearing whose centre O is the midpoint of the distance CD between the load application points.

The arrangement of this type of assembly is hyperstatic. (3 seating points: E, C, D) and can only be likened approximately to an arrangement on two assemblies (seating points E and O) if the distance CD is less than $L/5$ and the rigidity of the assembly is satisfactory (misalignment $< 0.06^\circ$).

In all other cases, consult SNR.

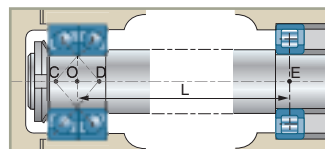
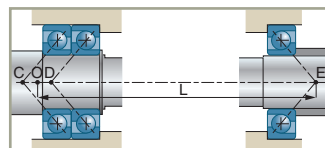
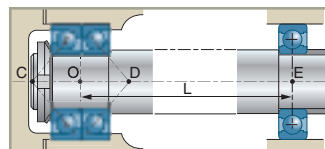



■ Equivalent dynamic load of the double assembly (ISO 281 Standard)

Arrangements assembled in an O or X	$P = F_r + 0.55 F_a$	if	$F_a / F_r \leq 1.14$
	$P = 0.57 F_r + 0.93 F_a$	if	$F_a / F_r > 1.14$
Tandem assemblies	$P = F_r$	if	$F_a / F_r \leq 1.14$
	$P = 0.35 F_r + 0.57 F_a$	if	$F_a / F_r > 1.14$

■ Basic dynamic capacity of the double assembly

Basic dynamic capacity of an assembly of two identical matched bearings:

$$C_e = 1.625 C$$

■ Equivalent static load of a double assembly

For an O or X assembly:

$$P_0 = F_r + 0.52 F_a$$

For a tandem assembly, the value of P_0 is the greater of the two values obtained using the following formula:

$$P_0 = F_r$$

$$P_0 = 0.5 F_r + 0.26 F_a$$

■ Basic static capacity of the assemblies

The static capacity of the assembly of two identical bearings is twice that of a single bearing.

$$C_{0e} = 2 C_0$$

Suffixes

A	Optimised internal design with polyamide cage
B	Contact angle of 40°
BG	Contact angle of 40° and non-preloaded universal pairing
M	Machined brass cage centred on the balls

Single-row angular-contact ball bearings (continued)

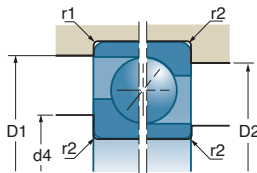
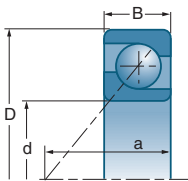

d		D	B	a				
					10 ³ N	10 ³ N	rpm*	rpm*
mm	References	mm	mm	mm				
15	7202 BA	35	11	16.0	8.0	4.4	16000	22000
17	7203 B	40	12	18.0	9.9	5.5	14000	20000
	7203 BGA	40	12	18.0	16.1	11.0	14000	19000
20	7204 BA	47	14	21.0	13.3	7.6	12000	17000
	7204 BGA	47	14	21.0	21.6	15.3	11000	16000
	7304 B	52	15	22.5	17.3	9.7	11000	16000
	7304 BGA	52	15	22.6	30.5	20.9	11000	15000
25	7205 BGA	52	15	24.0	15.8	9.4	10000	14000
	7305 BGA	62	17	26.8	42.5	30.0	9100	12000
30	7206 BGA	62	16	27.0	20.5	13.5	8700	12000
	7306 BGA	72	19	31.0	32.5	20.1	7800	10900
35	7207 BGA	72	17	31.0	27.0	18.4	7400	10400
	7307 BA	80	21	35.0	39.5	25.0	6900	9700
	7307 BGA	80	21	35.0	39.5	25.0	6900	9700
40	7208 BA	80	18	34.0	32.0	23.0	6600	9300
	7208 BGA	80	18	34.0	32.0	23.0	6600	9300
	7208 BGM	80	18	34.0	32.0	23.0	6600	9300
	7308 BA	90	23	39.0	49.5	32.5	6100	8600
	7308 BGA	90	23	39.0	49.5	32.5	6100	8600
	7308 BGM	90	23	39.0	46.5	29.5	6100	8600
45	7209 BA	85	19	37.0	36.0	26.5	6100	8600
	7209 BGA	85	19	37.0	36.0	26.5	6100	8600
	7209 BGM	85	19	37.0	34.5	24.4	6100	8600
	7309 BA	100	25	43.0	69.0	47.0	5500	7700
	7309 BGA	100	25	43.0	69.0	47.0	5500	7700
	7309 BGM	100	25	43.0	56.0	36.0	5500	7700
50	7210 BGA	90	20	39.0	37.5	28.5	5700	8000
	7210 BGM	90	20	39.0	35.5	26.5	5700	8000
	7310 BA	110	27	47.0	69.0	47.0	5000	7000
	7310 BGA	110	27	47.0	69.0	47.0	5000	7000
	7310 BGM	110	27	47.0	69.0	47.0	5000	7000

* These are the speed limits according to the SNR concept (see pages 85 to 87).

Characteristics

■ Single-row angular-contact ball bearings

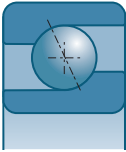

References	d4 min	D2 max	D1 max	r2 max	r1 max	kg
7202 BA	19	31	32.0	0.6	0.3	0.045
7203 B 7203 BGA	20.5 20.5	36.5 36.5	36.5 36.5	0.6 0.6	0.6 0.3	0.064 0.065
7204 BA 7204 BGA 7304 B 7304 BGA	26 26 26 26	41 41 46 46	43.0 43.0 48.5 48.5	1.0 1.0 1.0 1.1	0.6 0.6 0.6 0.6	0.107 0.104 0.150 0.143
7205 BGA 7305 BGA	31 32	46 55	48.0 58.0	1.0 1.1	0.6 0.6	0.131 0.223
7206 BGA 7306 BGA	36 37	56 65	58.0 68.0	1.0 1.0	0.6 0.6	0.210 0.349
7207 BGA 7307 BA 7307 BGA	42 44 44	65 71 71	68.0 75.0 75.0	1.0 1.5 1.5	0.6 1.0 1.0	0.287 0.457 0.475
7208 BA 7208 BGA 7208 BGM 7308 BA 7308 BGA 7308 BGM	47 47 47 49 49 49	73 73 73 81 81 81	76.0 76.0 76.0 85.0 85.0 85.0	1.0 1.0 1.0 1.5 1.5 1.5	0.6 0.6 0.6 1.0 1.0 1.0	0.373 0.373 0.373 0.626 0.626 0.626
7209 BA 7209 BGA 7209 BGM 7309 BA 7309 BGA 7309 BGM	52 52 52 54 54 54	78 78 78 91 91 91	81.0 81.0 81.0 95.0 95.0 95.0	1.0 1.0 1.0 1.5 1.5 1.5	0.6 0.6 0.6 1.0 1.0 1.0	0.414 0.414 0.414 0.835 0.835 0.835
7210 BGA 7210 BGM 7310 BA 7310 BGA 7310 BGM	57 57 61 61 61	83 83 99 99 99	86.0 86.0 104.0 104.0 104.0	1.0 1.0 2.0 2.0 2.0	0.6 0.6 1.0 1.0 1.0	0.466 0.466 1.080 1.080 1.080



Single-row angular-contact ball bearings (continued)

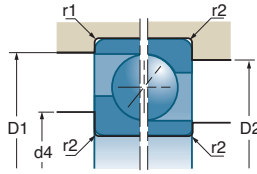
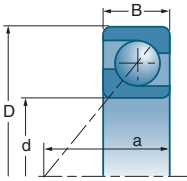



d		D	B	a				
					10°N	10°N	rpm*	rpm*
mm	References	mm	mm	mm				
55	7211 BA	100	21	43.0	46.5	36.0	5100	7200
	7211 BGA	100	21	43.0	46.5	36.0	5100	7200
	7211 BGM	100	21	43.0	44.0	33.5	5100	7200
	7311 BA	120	29	51.0	79.0	56.0	4500	6400
	7311 BGA	120	29	51.0	79.0	56.0	4500	6400
	7311 BGM	120	29	51.0	79.0	56.0	4500	6400
60	7212 BA	110	22	47.0	56.0	44.5	4700	6500
	7212 BGA	110	22	47.0	56.0	44.5	4700	6600
	7212 BGM	110	22	47.0	54.0	41.5	4700	6600
	7312 BA	130	31	55.0	90.0	65.0	4200	5900
	7312 BGA	130	31	55.0	90.0	65.0	4200	5800
	7312 BGM	130	31	55.0	85.0	60.0	4200	5800
65	7213 BA	120	23	50.5	64.0	53.0	4300	6000
	7213 BGA	120	23	50.5	64.0	53.0	4300	6000
	7213 BGM	120	23	50.5	61.0	49.5	4300	6000
	7213 BM	120	23	50.5	61.0	49.5	4300	6000
	7313 BGA	140	33	60.0	102.0	75.0	3900	5400
	7313 BGM	140	33	60.0	102.0	75.0	3900	5400
70	7214 BA	125	24	53.0	69.0	58.0	4100	5700
	7214 BGA	125	24	53.0	69.0	58.0	4100	5700
	7214 BGM	125	24	53.0	66.0	54.0	4100	5700
	7314 BGA	150	35	64.0	114.0	86.0	3600	5000
	7314 BGM	150	35	64.0	114.0	86.0	3600	5000
	75	7215 BA	130	25	56.0	69.0	58.0	3900
7215 BGA		130	25	56.0	69.0	58.0	3900	5500
7215 BGM		130	25	56.0	69.0	58.0	3900	5400
7315 BGM		160	37	68.0	128.0	100.0	3400	4700
80		7216 BGM	140	26	59.0	80.0	69.0	3600
	7316 BGM	170	39	72.0	140.0	114.0	3200	4400
85	7217 BGM	150	28	63.0	90.0	80.0	3400	4700
	7317 BGM	180	41	76.0	151.0	127.0	3000	4200
90	7218 BGM	160	30	67.0	107.0	94.0	3200	4400
	7318 BGM	190	43	80.0	162.0	140.0	2800	4000

* These are the speed limits according to the SNR concept (see pages 85 to 87).

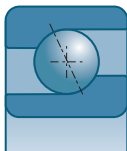
■ Single-row angular-contact ball bearings (continued)

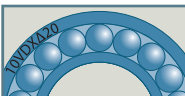

	d4 min	D2 max	D1 max	r2 max	r1 max	
References	mm	mm	mm	mm	mm	kg
7211 BA	64	91	95.0	1.5	1.0	0.633
7211 BGA	64	91	95.0	1.5	1.0	0.633
7211 BGM	64	91	95.0	1.5	1.0	0.633
7311 BA	66	109	114.0	2.0	1.0	1.410
7311 BGA	66	109	114.0	2.0	1.0	1.410
7311 BGM	66	109	114.0	2.0	1.0	1.410
7212 BA	69	101	105.0	1.5	1.0	0.798
7212 BGA	69	101	105.0	1.5	1.0	0.798
7212 BGM	69	101	105.0	1.5	1.0	0.798
7312 BA	72	118	123.0	2.1	1.0	1.810
7312 BGA	72	118	123.0	2.1	1.0	1.810
7312 BGM	72	118	123.0	2.1	1.0	1.810
7213 BA	74	111	115.0	1.5	1.0	1.030
7213 BGA	74	111	115.0	1.5	1.0	1.030
7213 BGM	74	111	115.0	1.5	1.0	1.100
7213 BM	72	113	115.0	1.5	1.0	1.100
7313 BGA	77	128	133.0	2.1	1.0	2.160
7313 BGM	77	128	133.0	2.1	1.0	2.324
7214 BA	79	116	120.0	1.5	1.0	1.140
7214 BGA	79	116	120.0	1.5	1.0	1.140
7214 BGM	79	116	120.0	1.5	1.0	1.185
7314 BGA	82	138	143.0	2.1	1.0	2.650
7314 BGM	82	138	143.0	2.1	1.0	2.800
7215 BA	84	121	125.0	1.5	1.0	1.190
7215 BGA	84	121	125.0	1.5	1.0	1.190
7215 BGM	84	121	125.0	1.5	1.0	1.291
7315 BGM	87	148	153.0	2.1	1.0	3.170
7216 BGM	91	129	134.0	2.0	1.0	1.460
7316 BGM	92	158	163.0	2.1	1.0	4.280
7217 BGM	96	139	144.0	2.0	1.0	1.920
7317 BGM	99	166	173.0	2.5	1.0	4.580
7218 BGM	101	149	154.0	2.0	1.0	2.350
7318 BGM	104	176	183.0	2.5	1.0	5.320

Single-row angular-contact ball bearings (continued)

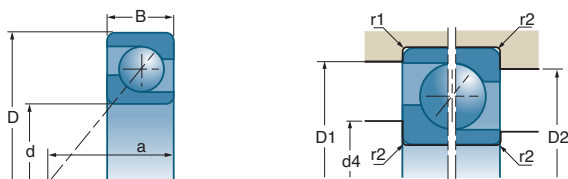



d		D	B	a				
							10°N	10°N
mm	References	mm	mm	mm				
95	7219 BGM 7319 BGM	170	32	72.0	116.0	101.0	3000	4200
		200	45	84.0	172.0	154.0	2700	3800
100	7220 BGM 7320 BGM	180	34	76.0	130.0	114.0	2800	4000
		215	47	90.0	194.0	181.0	2500	3500
105	7321 BGM	225	49	94.0	241.0	230.0	2400	3400
110	7222 BGM 7322 BGM	200	38	84.0	154.0	144.0	2500	3600
		240	50	98.0	226.0	225.0	2200	3200
120	7224 BGM 7324 BGM	215	40	90.0	161.0	165.0	2400	3300
		260	55	108.0	250.0	260.0	2100	2900
130	7226 BGM 7326 BGM	230	40	96.0	177.0	180.0	2200	3100
		280	58	115.0	275.0	300.0	1900	2700
140	7228 BGM 7328 BGM	250	42	103.0	197.0	212.0	2100	2900
		300	62	123.0	300.0	340.0	1800	2500
150	7230 BGM 7330 BGM	270	45	111.0	225.0	255.0	1900	2600
		320	65	131.0	330.0	390.0	1700	2300
160	7232 BGM 7332 BGM	290	48	118.0	238.0	280.0	1700	2400
		340	68	139.0	360.0	450.0	1600	2200
170	7234 BGM 7334 BGM	310	52	127.0	265.0	325.0	1600	2300
		360	72	147.0	390.0	510.0	1500	2100

* These are the speed limits according to the SNR concept (see pages 85 to 87).

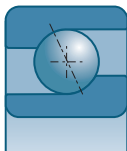
■ Single-row angular-contact ball bearings (continued)

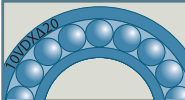

	d4 min	D2 max	D1 max	r2 max	r1 max	
References	mm	mm	mm	mm	mm	kg
7219 BGM 7319 BGM	107 109	158 186	163.0 193.0	2.1 2.5	1.0 1.0	2.780 6.180
7220 BGM 7320 BGM	112 114	168 201	173.0 208.0	2.1 2.5	1.0 1.0	3.410 7.650
7321 BGM	119	211	218.0	2.5	1.0	9.460
7222 BGM 7322 BGM	122 124	188 226	193.0 233.0	2.1 2.5	1.0 1.0	4.720 10.400
7224 BGM 7324 BGM	132 134	203 246	208.0 253.0	2.1 2.5	1.0 1.0	6.210 14.400
7226 BGM 7326 BGM	144 147	216 263	223.0 271.0	2.5 3.0	1.0 1.5	6.920 17.500
7228 BGM 7328 BGM	154 157	236 283	243.0 291.0	2.5 3.0	1.0 1.5	8.910 21.600
7230 BGM 7330 BGM	164 167	256 303	263.0 311.0	2.5 3.0	1.0 1.5	11.600 26.000
7232 BGM 7332 BGM	174 177	276 323	283.0 331.0	2.5 3.0	1.0 1.5	28.000 30.500
7234 BGM 7334 BGM	187 187	293 343	301.0 351.0	3.0 3.0	1.5 1.5	35.000 34.342

4-point angular-contact bearings

Definition and capabilities

4-point angular contact bearings accept axial loads in both directions. They are often associated with a radial contact bearing.

→ Definition

The design of this bearing results from the theoretical superposition of the two sections of matched angular-contact bearings in an X or O arrangement. The curvature of the raceways is consequently elliptical and displays two loading lines (contact angle 35°) which gives four points of contact on the balls.

The two-part inner ring can be filled with more balls than radial ball bearings.

■ Cage

The cage is usually made in machined brass centred on the inner or outer ring, joining the ring of balls to the outer ring.

→ Capabilities

■ Load and speed

These bearings are designed to:

- withstand combined loads with a predominant axial component

$$F_a / F_r \geq 1.25$$

- withstand axial loads in both directions
- accept relatively high speeds of rotation

■ Misalignment

The construction of these bearings limits them to very small misalignment values, in the range of 0.06°.

Series

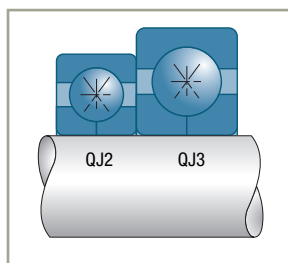

Tolerances and clearances

→ Tolerances

These bearings are supplied in normal tolerance classes.

→ Clearance

■ Axial clearance

The axial clearance is not standardised.
The values are communicated by SNR on request.

■ Radial clearance

The relation between the axial clearance J_a and the corresponding radial clearance J_r can be calculated using the following approximation formula

$$J_r = 0.7 J_a$$

Design criteria

■ Bearing life

$$P = F_r + 0.66 F_a \quad \text{if } F_a / F_r \leq 0.95$$

■ Equivalent dynamic load

$$P = 0.6 F_r + 1.07 F_a \quad \text{if } F_a / F_r > 0.95$$

■ Equivalent static load

$$P_0 = F_r + 0.58 F_a$$

Installation/assembly criteria

The axial clearance of this bearing is determined for conventional mounting on a rotating shaft with an interference fit j6 or k6 type.

The fit of the housing must be loose (H7), hence the need to prevent the ring from rotating in certain applications (version suffix N2).

The two inner half-rings must be held tight axially against a shoulder.

In most applications, this bearing is considered like a single assembly. It can sometimes be used like a double assembly playing the role of two bearings, thanks to the distance between the load application points.





Suffixes

MA	Machined brass cage centred on the outer ring
N2	Two retention slots on the outer ring

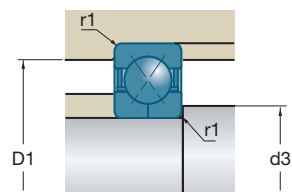
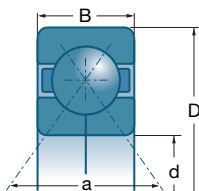

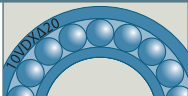
4-point angular-contact bearings (continued)





d		D	B	a				
mm	References	mm	mm	mm	10 ³ N	10 ³ N	rpm*	rpm*
30	QJ 306 MA	72	19	36	55.0	38.5	7900	11000
35	QJ 307 MA	80	21	41	59.0	46.5	7100	9500
40	QJ 308 MA	90	23	46	86.0	69.0	6300	8400
45	QJ 309 MA	100	25	52	95.0	75.0	5600	7500
50	QJ 310 MA	110	27	56	110.0	92.0	5100	6900
55	QJ 311 MA	120	29	61	127.0	109.0	4600	6200
60	QJ 312 MA	130	31	67	145.0	126.0	4300	5700
65	QJ 313 MA	140	33	72	164.0	145.0	4000	5300
70	QJ 314 MA	150	35	77	184.0	165.0	3700	5000
75	QJ 315N2 MA	160	37	82	212.0	204.0	3400	4600
80	QJ 316N2 MA	170	39	88	222.0	215.0	3200	4400
85	QJ 317N2 MA	180	41	93	246.0	255.0	3000	4100
90	QJ 318N2 MA	190	43	98	265.0	285.0	2900	3900

* These are the speed limits according to the SNR concept (see pages 85 to 87).

Characteristics

■ 4-points angular-contact bearings

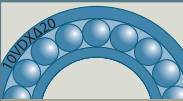

	d3 min	d3 max	D1 min	D1 max	r1 max	
References	mm	mm	mm	mm	mm	kg
QJ 306 MA	37	45.5	62.3	65	1.1	0.406
QJ 307 MA	44	50.5	68.4	71	1.5	0.550
QJ 308 MA	49	52.9	77.6	81	1.5	0.696
QJ 309 MA	54	59.2	86.7	91	1.5	1.050
QJ 310 MA	61	69	95.1	99	2	1.330
QJ 311 MA	66	75	103.4	109	2	1.675
QJ 312 MA	70	81	110	120	2.1	2.200
QJ 313 MA	78	90.5	120.3	127	2.1	2.700
QJ 314 MA	83	96	128.7	137	2.1	3.150
QJ 315 N2 MA	85	102	135	149	2.1	3.960
QJ 316 N2MA	93	110	145.6	157	2.1	4.500
QJ 317 N2 MA	95	114	155	167	3	5.540
QJ 318 N2 MA	102	121	163	177	3	6.440

Angular-contact bearings high precision MachLine® Range SNR

Definition and capabilities

Current machining integrates a whole series of properties which result from constant technological evolution and progress: high speed machining, downtime reduction, higher stiffness, integral sealing, maintenance cost-savings, ...

Machines provide increasingly higher performance levels in a context where productivity and environmental-friendliness must be paired.

The MachLine® range offers precise answers to all these issues.

Series and variations

■ High precision

- **SNR 71900V and 7000V series**, with excellent performance data to balance the need for speed, rigidity, capacity and precision.
- **7200G1 series**, specially designed to meet specifications set by applications with large, predominantly axial loads.
- **Variations** according to contact angle (C for 15° and H for 25°) and preload (light, medium or heavy).

■ Hybrid, ceramic balls CH

- **Possible variation** for all ranges, all series and all dimensions with Silicon Nitride balls and steel rings, combining the best qualities of the two materials.
- **Reduced operating temperature** and increased top speed. Reduced lubrication requirements as compared to a « conventional steel » bearing.
- **Increased rigidity and longer life.**



■ High speed ML

- Family made up of **series 71900 and 7000**, designed and developed by SNR to meet the increasingly stringent requirements in high speed mechanization.
- **Specially designed geometry**: reduction in ball diameter, increase in number of balls and optimization of cage guidance on outer ring.
- **Different variations** according to contact angle (C for 17° and H for 25°) and preload.

■ High speed sealed bearing MLE

- When oil lubrication is not required and grease lubrication is sufficient, SNR has a technically appropriate solution which is also economically attractive – the MLE family of bearings, **series 71900 and 7000**.
- **With nitrile rubber seals** on the outer ring, not in contact with the inner ring, the same top speed can be attained as with an open bearing lubricated with grease.
- **Variations** according to contact angle (C for 17° and H for 25°) and preload.

Design criteria

Consult our machine tools catalog MachLine®.

Angular-contact bearings high precision MachLine® Range SNR (continued)

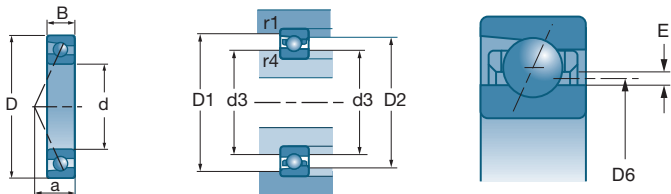

d	D	B		Kg	References	D2 max	d3 min	D1 max	r4 max	r1 max	D6	E	Balls	
													Diameter	Nb
mm	mm	mm				mm	mm	mm	mm	mm	mm	mm	mm	
10	22	6	0.010	71900	17.8	13.6	18.8	0.3	0.1	14.7	1.10	3.175	11	
	26	8	0.018	7000	21.4	14.7	22.7	0.3	0.1	16.5	1.85	4.762	10	
	30	9	0.030	7200	24.5	16.0	25.5	0.6	0.3	18.2	2.25	5.556	10	
12	24	6	0.011	71901	19.6	15.4	20.6	0.3	0.1	16.5	1.30	3.175	13	
	28	8	0.020	7001	23.4	16.7	24.7	0.3	0.1	18.5	1.65	4.762	11	
	32	10	0.037	7201	26.0	18.3	27.9	0.6	0.3	20.5	1.85	5.953	10	
15	28	7	0.015	71902	24.3	18.7	25.4	0.3	0.1	20.0	1.40	3.969	13	
	32	9	0.028	7002	26.9	20.2	28.2	0.3	0.1	22.0	1.65	4.762	13	
	35	11	0.044	7202	29.0	21.1	31.3	0.6	0.3	23.3	2.10	5.953	11	
17	30	7	0.017	71903	26.6	21.0	27.7	0.3	0.1	23.0	1.45	3.969	14	
	35	10	0.037	7003	29.4	22.7	30.7	0.3	0.1	24.4	1.75	4.762	14	
	40	12	0.065	7203	33.0	24.1	35.2	0.6	0.3	26.5	2.45	6.747	11	
20	37	9	0.036	71904	31.9	25.1	33.2	0.3	0.15	26.8	1.78	4.762	15	
	42	12	0.063	7004	35.5	26.6	37.3	0.6	0.3	29.0	2.40	6.350	13	
	47	14	0.105	7204	38.6	28.5	41.4	1.0	0.3	31.4	2.80	7.938	11	
25	42	9	0.041	71905	37.4	30.6	38.7	0.3	0.15	32.3	1.75	4.762	17	
	47	12	0.076	7005	40.1	32.2	42.3	0.6	0.3	34.2	2.05	6.350	15	
	52	15	0.128	7205	44.5	34.0	46.9	1.0	0.3	36.8	2.80	7.938	13	
30	47	9	0.047	71906	41.9	35.1	43.2	0.3	0.15	36.8	1.73	4.762	18	
	55	13	0.112	7006	47.0	38.1	49.5	1.0	0.3	40.4	2.35	7.144	16	
	62	16	0.200	7206	52.1	40.4	55.4	1.0	0.3	43.5	3.15	9.525	13	
35	55	10	0.075	71907	48.6	41.4	50.4	0.6	0.15	43.2	1.85	5.556	18	
	62	14	0.150	7007	53.1	43.2	56.3	1.0	0.3	46.0	2.85	7.938	16	
	72	17	0.290	7207	61.0	47.4	64.5	1.1	0.3	50.9	3.50	11.112	13	
40	62	12	0.110	71908	55.2	46.8	57.2	0.6	0.15	49.0	2.18	6.350	19	
	68	15	0.185	7008	59.0	49.2	61.8	1.0	0.3	51.8	2.55	7.938	18	
	80	18	0.370	7208	67.6	52.8	71.8	1.1	0.6	56.9	4.05	11.906	13	
45	68	12	0.128	71909	60.7	52.3	62.7	0.6	0.3	54.5	2.15	6.350	20	
	75	16	0.238	7009	65.0	54.7	68.6	1.0	0.3	57.5	2.85	8.731	18	
	85	19	0.416	7209	72.5	57.4	77.5	1.1	0.6	61.7	4.30	12.700	14	

Characteristics



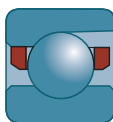



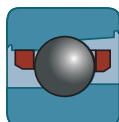



■ MachLine, high precision standard bearing for machine tools



Standard





CH

 Serie C	a	 c	 c ₀	 rpm*	 rpm*	 Serie H	a	 c	 c ₀	 rpm*	 rpm*
71900 CV	5	3 050	1 520	71 000	108 000	71900 HV	7	2 900	1 450	67 000	103 000
7000 CV	6	5 700	2 750	60 000	95 000	7000 HV	8	5 500	2 650	53 000	82 000
7200 CG1	7	7 500	3 700	53 000	82 000	7200 HG1	9	7 200	3 550	46 000	72 000
71901 CV	5	3 400	1 860	64 000	97 000	71901 HV	7	3 250	1 770	61 000	93 000
7001 CV	7	6 200	3 200	54 000	85 000	7001 HV	9	6 000	3 050	48 000	72 000
7201 CG1	8	8 600	4 300	48 000	74 000	7201 HG1	10	8 300	4 200	42 000	65 000
71902 CV	6	5 100	2 850	52 000	79 000	71902 HV	9	4 850	2 750	49 000	75 000
7002 CV	8	7 000	4 000	46 000	72 000	7002 HV	10	6 700	3 850	42 000	62 000
7202 CG1	9	9 400	5 000	42 000	65 000	7202 HG1	11	9 100	4 850	37 000	57 000
71903 CV	7	5 300	3 150	46 000	70 000	71903 HV	9	5 100	3 000	44 000	68 000
7003 CV	8	7 400	4 450	41 000	65 000	7003 HV	11	7 000	4 250	37 000	56 000
7203 CG1	10	11 600	6 400	37 000	58 000	7203 HG1	13	11 200	6 200	32 000	50 000
71904 CV	8	7 700	4 900	39 000	60 000	71904 HV	11	7 300	4 650	37 000	57 000
7004 CV	10	11 800	7 100	35 000	55 000	7004 HV	13	11 300	6 800	31 000	47 000
7204 CG1	11	15 600	8 900	32 000	49 000	7204 HG1	15	15 000	8 500	28 000	43 000
71905 CV	9	8 300	5 800	33 000	50 000	71905 HV	12	7 800	5 500	31 000	47 000
7005 CV	11	13 000	8 600	30 000	47 000	7005 HV	14	12 400	8 200	26 000	40 000
7205 CG1	13	17 600	11 100	27 000	42 000	7205 HG1	16	16 900	10 600	24 000	37 000
71906 CV	10	8 400	6 300	29 000	44 000	71906 HV	13	8 000	5 900	27 000	42 000
7006 CV	12	16 700	11 700	25 000	40 000	7006 HV	16	15 900	11 200	22 000	34 000
7206 CG1	14	24 400	15 900	23 000	35 000	7206 HG1	19	23 400	15 200	20 000	31 000
71907 CV	11	11 100	8 500	25 000	38 000	71907 HV	15	10 500	8 100	23 000	36 000
7007 CV	13	21 000	15 500	23 000	35 000	7007 HV	18	20 000	14 800	21 000	31 000
7207 CG1	16	32 500	21 700	20 000	31 000	7207 HG1	21	31 000	20 700	17 000	27 000
71908 CV	13	14 700	11 800	21 000	33 000	71908 HV	18	13 900	11 100	20 000	31 000
7008 CV	15	21 600	16 800	21 000	33 000	7008 HV	20	20 500	16 000	20 000	30 000
7208 CG1	17	36 500	25 000	18 500	29 500	7208 HG1	23	35 000	24 100	16 500	25 500
71909 CV	14	15 400	10 700	20 000	30 000	71909 HV	19	14 500	10 100	18 000	26 000
7009 CV	16	27 400	19 200	19 000	28 000	7009 HV	22	26 000	18 100	18 000	24 000
7209 CG1	18	45 900	29 900	16 500	26 000	7209 HG1	25	43 800	28 500	15 000	22 500

* These are the speed limits according to the SNR concept (see pages 85 to 87).

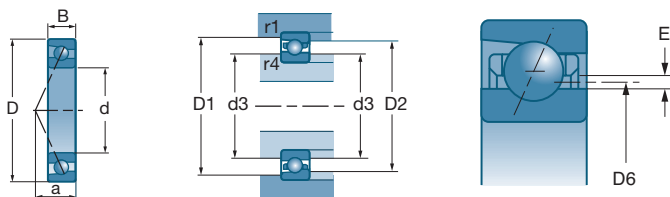
Angular-contact bearings high precision MachLine® Range SNR (continued)



d	D	B		Kg	References	D2 max	d3 min	D1 max	r4 max	r1 max	D6	E	Balls	
													Diameter	Nb
mm	mm	mm				mm	mm	mm	mm	mm	mm	mm	mm	
50	72	12	0.129	71910	65.2	56.8	67.2	0.6	0.3	58.9	2.13	6.350	21	
	80	16	0.256	7010	70.0	59.7	73.6	1.0	0.3	62.5	2.80	8.731	19	
	90	20	0.486	7210	76.9	62.5	82.7	1.1	0.6	66.7	4.20	12.700	15	
55	80	13	0.181	71911	72.5	62.1	75.8	1.0	0.3	65.4	2.25	7.144	21	
	90	18	0.390	7011	80.0	65.0	84.0	1.1	0.6	69.0	2.00	9.525	19	
	100	21	0.620	7211	87.0	68.0	92.5	1.5	0.6	72.5	2.10	14.288	14	
60	85	13	0.195	71912	77.5	67.1	80.8	1.0	0.3	70.4	2.25	7.144	23	
	95	18	0.420	7012	85.0	70.0	89.0	1.1	0.6	73.8	2.00	9.525	21	
	110	22	0.810	7212	95.0	75.0	101.5	1.5	0.6	79.5	2.30	15.875	14	
65	90	13	0.210	71913	82.5	72.5	86.0	1.0	0.3	74.5	1.25	7.144	27	
	100	18	0.440	7013	90.0	75.0	94.0	1.1	0.6	78.8	2.00	9.525	22	
	120	23	1.140	7213	104.0	81.0	109.0	1.5	0.6	87.0	2.30	15.875	15	
70	100	16	0.340	71914	91.0	79.0	95.0	1.0	0.3	81.5	1.50	8.731	24	
	110	20	0.610	7014	98.5	81.5	103.0	1.1	0.6	85.8	2.50	11.112	21	
	125	24	1.100	7214	109.0	86.0	116.0	1.5	0.6	91.4	2.60	17.462	14	
75	105	16	0.360	71915	96.0	84.0	100.0	1.0	0.3	86.3	1.50	8.731	26	
	115	20	0.650	7015	103.5	86.5	108.0	1.1	0.6	90.7	2.50	11.112	22	
	130	15	1.200	7215	114.0	91.0	121.0	1.5	0.6	96.4	2.60	17.462	15	
80	110	16	0.380	71916	101.0	89.0	105.0	1.0	0.3	91.2	1.50	8.731	27	
	125	22	0.850	7016	112.0	93.0	117.5	1.1	0.6	98.0	3.50	13.494	20	
	140	26	1.470	7216	122.5	97.5	130.0	2.0	1.0	103.4	2.80	19.050	15	
85	120	18	0.550	71917	110.0	95.0	114.0	1.1	0.6	98.6	1.80	9.525	27	
	130	22	0.900	7017	117.0	98.0	122.5	1.1	0.6	102.8	3.50	13.494	21	
	150	28	1.810	7217	131.0	104.0	140.0	2.0	1.0	110.3	3.10	20.638	15	
90	125	18	0.580	71918	115.0	100.0	119.0	1.1	0.6	103.5	1.80	9.525	29	
	140	24	1.160	7018	125.5	104.5	131.5	1.5	0.6	110.0	3.80	15.081	20	
	160	30	2.240	7218	139.0	111.0	149.0	2.0	1.0	117.2	3.30	22.225	15	
95	130	18	0.590	71919	120.0	105.0	124.0	1.1	0.6	108.3	2.00	10.319	28	
	145	24	1.210	7019	130.5	109.5	136.5	1.5	0.6	114.8	3.80	15.081	21	
100	140	20	0.820	71920	128.5	111.5	133.5	1.1	0.6	115.6	2.10	11.112	28	
	150	24	1.270	7020	135.5	114.5	141.5	1.5	0.6	119.7	3.80	15.081	22	
	180	34	3.230	7220	155.5	124.5	167.0	2.1	1.1	131.0	3.80	25.400	14	

■ MachLine, high precision standard bearing for machine tools (continued)

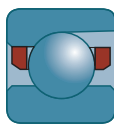

Standard

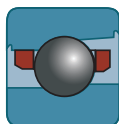

CH

Serie C	a mm	c N	C ₀ N		
				rpm*	rpm*
71910 CV	14	15 600	11 300	19 000	28 000
7010 CV	17	28 200	20 200	18 000	26 000
7210 CG1	19	48 000	32 600	15 500	24 500
71911 CV	16	18 700	13 700	16 500	25 000
7011 CV	19	30 500	26 000	16 000	24 000
7211 CG1	21	53 000	40 000	14 500	21 500
71912 CV	16	19 500	15 000	14 500	23 500
7012 CV	19	32 500	29 500	15 000	23 000
7212 CG1	22	65 000	49 000	12 500	19 500
71913 CV	17	21 700	21 900	14 500	22 000
7013 CV	20	33 000	31 000	14 000	21 000
7213 CG1	24	67 000	54 000	11 500	17 500
71914 CV	19	29 500	29 000	13 000	20 000
7014 CV	22	43 000	40 000	13 000	20 000
7214 CG1	25	77 000	60 000	11 000	16 500
71915 CV	20	30 500	31 500	12 500	19 000
7015 CV	23	44 000	42 000	12 000	19 000
7215 CG1	26	80 000	65 000	10 000	16 000
71916 CV	21	31 000	33 000	12 000	18 000
7016 CV	25	59 000	55 000	11 000	17 000
7216 CG1	28	94 000	78 000	9 400	15 000
71917 CV	23	36 500	39 000	11 000	17 000
7017 CV	25	61 000	59 000	10 500	16 000
7217 CG1	30	108 000	91 000	8 700	14 000
71918 CV	23	38 000	41 500	10 500	16 000
7018 CV	27	73 000	69 000	10 000	15 000
7218 CG1	32	124 000	105 000	8 100	12 500
71919 CV	24	43 000	47 500	9 900	15 000
7019 CV	28	74 000	73 000	9 700	14 500
71920 CV	26	49 000	55 000	9 500	14 500
7020 CV	29	76 000	77 000	9 300	14 000
7220 CG1	36	150 000	127 000	7 200	11 000

Serie H	a mm	c N	C ₀ N		
				rpm*	rpm*
71910 HV	20	14 700	10 600	16 000	24 000
7010 HV	23	26 600	19 300	14 500	22 000
7210 HG1	26	45 700	30 800	13 500	20 500
71911 HV	22	17 600	12 900	13 500	21 500
7011 HV	26	29 000	24 900	14 000	22 000
7211 HG1	29	51 000	38 000	12 500	19 500
71912 HV	23	18 400	14 200	13 500	20 000
7012 HV	27	30 500	28 000	14 000	21 000
7212 HG1	31	62 000	47 000	11 000	17 500
71913 HV	25	20 400	20 400	14 000	21 000
7013 HV	28	31 500	29 500	13 000	19 000
7213 HG1	33	64 000	52 000	10 000	16 500
71914 HV	28	28 000	27 500	12 500	19 000
7014 HV	31	40 500	37 500	12 500	19 000
7214 HG1	35	73 000	57 000	9 700	15 000
71915 HV	29	29 000	29 500	12 000	18 000
7015 HV	32	41 500	40 000	11 000	17 000
7215 HG1	36	76 000	62 000	9 100	14 500
71916 HV	30	29 500	30 500	11 000	17 000
7016 HV	35	56 000	53 000	10 500	16 000
7216 HG1	39	89 000	74 000	8 500	13 000
71917 HV	33	34 500	36 500	9 900	15 000
7017 HV	36	58 000	56 000	9 900	15 000
7217 HG1	41	103 000	86 000	7 800	12 000
71918 HV	34	35 500	39 000	9 900	15 000
7018 HV	39	69 000	66 000	9 200	14 000
7218 HG1	44	118 000	100 000	7 300	11 000
71919 HV	35	40 500	44 000	9 200	14 000
7019 HV	40	71 000	69 000	8 900	13 500
71920 HV	38	46 000	51 000	8 600	13 000
7020 HV	41	72 000	73 000	8 600	13 000
7220 HG1	50	143 000	121 000	6 400	9 800

* These are the speed limits according to the SNR concept (see pages 85 to 87).

Angular-contact bearings high precision MachLine® Range SNR (continued)

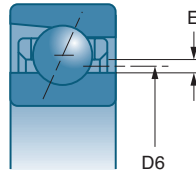
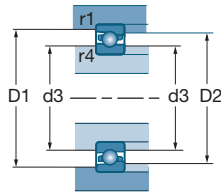
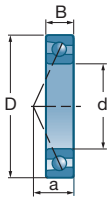

d	D	B	Kg	References	D2 max	d3 min	D1 max	r4 max	r1 max	D6	E	Balls	
												Diameter	Nb
105	145	20	0.860	71921	133.5	116.5	138.5	1.1	0.6	120.5	2.10	11.112	29
	160	26	1.610	7021	144.5	120.5	150.0	2.0	1.0	127.0	4.00	15.875	22
110	150	20	0.890	71922	138.5	121.5	143.5	1.1	0.6	125.5	2.10	11.112	30
	170	28	2.000	7022	153.0	127.0	160.0	2.0	1.0	134.0	4.50	17.462	21
	200	38	4.530	7222	172.5	137.5	185.5	2.1	1.1	145.0	4.30	28.575	14
120	165	22	1.190	71924	151.5	133.5	157.5	1.1	6.0	137.7	3.30	13.494	28
	180	28	2.150	7024	163.0	137.0	170.0	2.0	1.0	144.0	4.50	17.462	23
	215	40	5.600	7224	185.5	149.5	197.5	2.1	1.1	157.5	4.30	28.575	16
130	180	24	1.570	71926	165.0	145.0	172.0	1.5	0.6	149.8	3.70	15.081	27
	200	33	3.180	7026	179.5	150.5	189.0	2.0	1.0	158.0	5.30	20.638	21
140	190	24	1.680	71928	175.0	155.0	182.0	1.5	0.6	159.8	3.70	15.081	29
	210	33	3.420	7028	189.5	160.5	199.0	2.0	1.0	168.0	5.30	20.638	23
150	210	28	2.620	71930	192.5	167.5	199.0	2.0	1.0	174.0	4.10	16.669	29
	225	35	4.160	7030	203.0	172.0	213.0	2.1	1.0	180.0	5.70	22.225	23
160	220	28	2.760	71932	202.5	177.5	209.0	2.0	1.0	184.0	4.10	16.669	30
	240	38	5.130	7032	216.0	184.0	227.0	2.1	1.0	192.0	6.20	23.812	23
170	230	28	2.910	71934	212.5	187.5	219.0	2.0	1.0	194.0	4.10	16.669	32
	260	42	6.980	7034	232.5	197.5	246.0	2.1	1.1	206.4	6.60	25.400	23
180	250	33	4.260	71936	229.0	201.0	237.5	2.0	1.0	208.3	4.70	19.050	30
	280	46	9.000	7036	249.5	210.5	264.0	2.1	1.1	219.8	7.80	30.163	21
190	260	33	4.480	71938	239.0	211.0	247.5	2.0	1.0	218.3	4.70	19.050	32
	290	46	9.400	7038	259.5	220.5	274.0	2.1	1.1	229.8	7.80	30.163	22
200	280	38	6.160	71940	255.5	224.5	266.0	2.1	1.0	232.0	5.50	23.812	27
	310	51	12.150	7040	276.5	233.5	292.0	2.1	1.1	243.6	8.60	33.338	21
220	300	38	6.770	71944	275.5	244.5	286.0	2.1	1.0	252.0	5.50	22.225	31
	340	56	16.280	7044	304.0	256.0	321.0	3.0	1.1	268.6	8.60	33.338	23
240	320	38	7.270	71948	295.5	264.5	306.0	2.1	1.0	272.0	5.50	22.225	33

■ MachLine, high precision standard bearing for machine tools (continued)

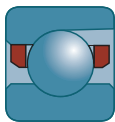

Standard

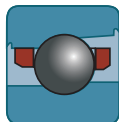

CH

Serie C	a mm	c N	C ₀ N		
				rpm*	rpm*
71921 CV 7021 CV	27 31	50 000 84 000	57 000 86 000	9 200 8 800	14 000 13 500
71922 CV 7022 CV 7222 CG1	27 33 40	51 000 97 000 177 000	59 000 98 000 160 000	8 900 8 300 6 300	13 500 12 500 9 700
71924 CV 7024 CV 7224 CG1	30 34 42	70 000 102 000 193 000	81 000 109 000 187 000	8 200 7 700 5 700	12 500 11 500 8 700
71926 CV 7026 CV	33 39	84 000 131 000	98 000 137 000	7 500 7 000	11 500 10 500
71928 CV 7028 CV	34 40	87 000 138 000	105 000 152 000	7 200 6 600	11 000 10 000
71930 CV 7030 CV	38 43	105 000 158 000	128 000 176 000	6 500 6 200	9 000 9 300
71932 CV 7032 CV	39 46	106 000 179 000	132 000 202 000	6 200 5 800	9 400 8 800
71934 CV 7034 CV	41 50	107 000 200 000	140 000 230 000	5 800 5 400	8 900 8 100
71936 CV 7036 CV	45 54	135 000 244 000	173 000 290 000	5 400 5 000	8 300 7 600
71938 CV 7038 CV	47 55	139 000 250 000	183 000 305 000	5 200 4 800	7 900 7 300
71940 CV 7040 CV	51 60	192 000 280 000	243 000 355 000	4 800 4 500	7 400 6 900
71944 CV 7044 CV	54 66	180 000 295 000	242 000 395 000	4 400 4 100	6 800 6 200
71948 CV	57	185 000	255 000	4 200	6 400

Serie H	a mm	c N	C ₀ N		
				rpm*	rpm*
71921 HV 7021 HV	39 44	47 000 79 000	53 000 81 000	8 600 7 900	13 000 12 000
71922 HV 7022 HV 7222 HG1	40 47 55	47 500 92 000 169 000	55 000 93 000 153 000	8 200 7 600 5 600	12 500 11 500 8 700
71924 HV 7024 HV 7224 HG1	44 49 59	66 000 96 000 184 000	76 000 103 000 178 000	7 500 6 900 5 100	11 500 10 500 7 800
71926 HV 7026 HV	48 55	79 000 124 000	92 000 130 000	6 900 6 500	10 500 9 800
71928 HV 7028 HV	50 57	82 000 130 000	98 000 144 000	6 400 6 100	9 800 9 200
71930 HV 7030 HV	56 61	99 000 149 000	120 000 167 000	5 900 5 700	9 000 8 600
71932 HV 7032 HV	58 66	100 000 169 000	123 000 191 000	5 600 5 300	8 500 8 100
71934 HV 7034 HV	61 71	103 000 189 000	131 000 218 000	5 300 5 000	8 100 7 500
71936 HV 7036 HV	67 77	127 000 231 000	161 000 275 000	4 900 4 600	7 500 7 000
71938 HV 7038 HV	69 79	131 000 237 000	171 000 290 000	4 700 4 400	7 200 6 700
71940 HV 7040 HV	75 85	181 000 265 000	229 000 335 000	4 400 4 200	6 800 6 300
71944 HV 7044 HV	77 93	170 000 280 000	226 000 375 000	4 000 3 700	6 200 5 700
71948 HV	84	174 000	238 000	3 800	5 800

* These are the speed limits according to the SNR concept (see pages 85 to 87).

Angular-contact bearings high precision MachLine® Range SNR (continued)

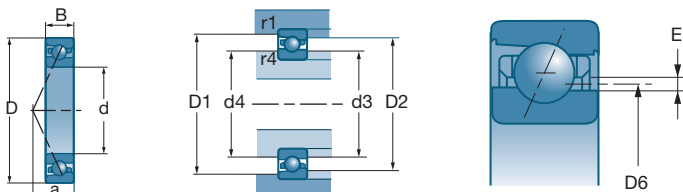

d	D	B	Kg	References	D2 max	d3 min	d4	D1 max	r4 max	r1 max	D6	E	Balls	
													Diameter	Nb
10	22	6	0.010	ML 71900	17.2	13.3	13.6	17.8	0.3	0.1	14.4	1.05	2.381	14
	26	8	0.018	ML 7000	19.5	14.2	14.7	20.1	0.3	0.1	15.7	1.53	3.175	11
12	24	6	0.011	ML 71901	19.0	15.1	15.4	19.6	0.3	0.1	16.2	1.05	2.381	14
	28	8	0.020	ML 7001	21.5	16.2	16.7	22.1	0.3	0.1	17.7	1.58	3.175	13
15	28	7	0.015	ML 71902	23.3	18.3	18.7	23.7	0.3	0.1	19.7	1.35	2.778	16
	32	9	0.028	ML 7002	25.7	19.4	20.2	26.8	0.3	0.1	21.3	1.85	3.969	13
17	30	7	0.017	ML 71903	25.6	20.6	21.0	26.0	0.3	0.1	22.0	1.35	2.778	18
	35	10	0.037	ML 7003	28.4	22.0	22.7	29.5	0.3	0.1	23.9	1.85	3.969	15
20	37	9	0.036	ML 71904	30.7	24.5	25.1	31.8	0.3	0.2	26.3	1.75	3.969	16
	42	12	0.063	ML 7004	34.3	25.3	26.6	35.7	0.6	0.3	27.9	2.63	5.556	14
25	42	9	0.041	ML 71905	36.2	30.0	30.6	37.3	0.3	0.2	31.8	1.75	3.969	19
	47	12	0.076	ML 7005	39.9	30.9	32.2	41.3	0.6	0.3	33.5	2.63	5.556	17
30	47	9	0.047	ML 71906	40.7	34.5	35.1	41.8	0.3	0.2	36.2	1.73	3.969	22
	55	13	0.112	ML 7006	45.8	36.8	38.1	47.2	1.0	0.3	39.4	2.63	5.556	20
35	55	10	0.075	ML 71907	47.1	40.8	41.4	48.2	0.6	0.2	42.7	1.90	3.969	26
	62	14	0.149	ML 7007	51.5	41.5	43.2	53.6	1.0	0.3	44.6	3.10	6.350	20
40	62	12	0.109	ML 71908	53.1	45.3	46.8	54.4	0.6	0.2	47.6	2.25	4.762	25
	68	15	0.185	ML 7008	57.5	47.5	49.2	59.6	1.0	0.3	50.5	3.00	6.350	22
45	68	12	0.128	ML 71909	58.6	50.8	52.3	59.9	0.6	0.3	53.0	2.23	4.762	28
	75	16	0.238	ML 7009	63.0	53.0	54.7	65.0	1.0	0.3	56.1	3.05	6.350	22
50	72	12	0.129	ML 71910	63.1	55.3	56.8	64.4	0.6	0.3	57.5	2.23	4.762	30
	80	16	0.256	ML 7010	68.0	58.0	59.7	70.0	1.0	0.3	61.0	3.00	6.350	25
55	80	13	0.177	ML 71911	73.5	60.5	62.5	76.5	1.0	0.3	65.0	1.28	6.350	25
	90	18	0.396	ML 7011	79.5	65.5	66.5	83.5	1.1	0.6	69.5	1.70	7.938	22
60	85	13	0.190	ML 71912	78.5	65.5	67.5	81.5	1.0	0.3	70.0	1.28	6.350	27
	95	18	0.426	ML 7012	84.5	70.5	71.5	88.5	1.1	0.6	74.4	1.67	7.938	24
65	90	13	0.202	ML 71913	83.5	70.5	72.5	86.5	1.0	0.3	75.0	1.25	6.350	29
	100	18	0.445	ML 7013	89.5	74.0	76.5	93.5	1.1	0.6	79.4	1.67	7.938	26

■ MachLine, high speed and precision bearing for machine tools

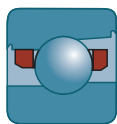

ML

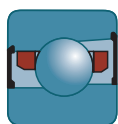

MLE

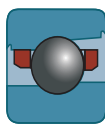

MLCH

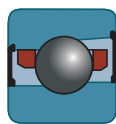

MLECH

Serie C	mm	N	N		
				rpm*	rpm*
ML 71900 CV	5	1 430	680	101 500	135 000
ML 7000 CV	6	2 040	920	94 000	125 000
ML 71901 CV	5	1 490	705	90 000	120 000
ML 7001 CV	7	2 280	1 110	82 500	110 000
ML 71902 CV	6	2 030	1 030	75 000	100 000
ML 7002 CV	8	3 450	1 710	69 000	92 000
ML 71903 CV	7	2 170	1 180	67 500	90 000
ML 7003 CV	8	3 750	2 020	61 500	82 000
ML 71904 CV	8	3 900	2 080	56 500	75 000
ML 7004 CV	10	6 550	3 600	52 500	70 000
ML 71905 CV	9	4 300	2 550	47 500	63 000
ML 7005 CV	11	7 450	4 500	44 500	59 000
ML 71906 CV	10	4 650	3 000	41 500	55 000
ML 7006 CV	12	8 300	5 150	37 500	50 000
ML 71907 CV	11	5 100	3 600	35 500	47 000
ML 7007 CV	13	10 500	6 700	33 000	44 000
ML 71908 CV	13	6 950	4 950	31 500	42 000
ML 7008 CV	15	11 000	7 500	29 500	39 000
ML 71909 CV	14	7 350	5 550	28 500	38 000
ML 7009 CV	16	10 900	7 600	27 000	36 000
ML 71910 CV	14	7 600	6 000	26 500	35 000
ML 7010 CV	17	11 700	8 700	25 000	33 000
ML 71911 CV	16	16 400	16 100	23 000	34 000
ML 7011 CV	19	23 300	21 700	22 000	30 500
ML 71912 CV	16	17 000	17 200	20 000	32 500
ML 7012 CV	19	24 400	24 000	19 000	28 500
ML 71913 CV	17	17 600	18 400	19 000	30 500
ML 7013 CV	20	25 500	26 000	18 000	27 000

Serie H	mm	N	N		
				rpm*	rpm*
ML71900 HV	7	1 360	645	94 000	125 000
ML 7000 HV	8	1 950	870	82 500	110 000
ML71901 HV	7	1 410	670	82 500	110 000
ML 7001 HV	9	2 180	1 050	75 000	100 000
ML71902 HV	9	1 930	980	67 500	90 000
ML 7002 HV	10	3 300	1 630	62 500	83 000
ML71903 HV	9	2 060	1 110	61 500	82 000
ML 7003 HV	11	3 600	1 820	55 500	74 000
ML71904 HV	11	3 700	1 970	51 000	68 000
ML 7004 HV	13	6 300	3 400	47 500	63 000
ML71905 HV	12	4 100	2 400	43 000	57 000
ML 7005 HV	14	7 100	4 050	40 000	53 000
ML71906 HV	13	4 400	2 850	37 500	50 000
ML 7006 HV	16	7 800	4 900	34 500	46 000
ML71907 HV	15	4 800	3 400	32 500	43 000
ML 7007 HV	18	10 000	6 350	30 000	40 000
ML71908 HV	18	6 550	4 650	28 500	38 000
ML 7008 HV	20	10 500	7 100	27 000	36 000
ML71909 HV	19	6 950	5 250	25 500	34 000
ML 7009 HV	22	10 300	7 200	24 000	32 000
ML71910 HV	20	7 150	5 650	24 000	32 000
ML 7010 HV	23	11 100	8 200	22 500	30 000
ML71911 HV	22	15 500	15 000	20 800	30 000
ML 7011 HV	26	22 000	20 600	19 000	27 000
ML71912 HV	24	16 000	16 100	19 000	28 700
ML 7012 HV	27	23 000	22 600	17 000	25 500
ML71913 HV	25	16 600	17 200	17 500	26 000
ML 7013 HV	28	23 900	24 400	16 000	24 500

* These are the speed limits according to the SNR concept (see pages 85 to 87).

Angular-contact bearings high precision MachLine® Range SNR (continued)

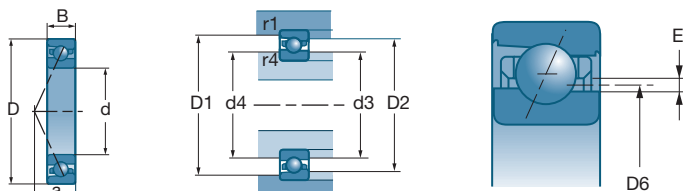

d	D	B	Kg	References	D2 max	d3 min	d4	D1 max	r4 max	r1 max	D6	E	Balls	
													Diameter	Nb
70	100	16	0.330	ML 71914	92.0	76.5	79.0	95.5	1.0	0.3	81.9	1.63	7.938	26
	110	20	0.625	ML 7014	98.0	81.5	83.0	102.5	1.1	0.6	86.4	2.07	9.525	24
75	105	16	0.349	ML 71915	97.0	81.5	84.0	100.5	1.0	0.3	86.9	1.63	7.938	28
	115	20	0.658	ML 7015	103.0	86.5	88.0	107.5	1.1	0.6	91.4	2.07	9.525	25
80	110	16	0.370	ML 71916	102.0	86.5	89.0	105.5	1.0	0.3	91.9	1.63	7.938	30
	125	22	0.874	ML 7016	111.5	93.0	94.5	116.5	1.1	0.6	98.4	2.49	11.113	23
85	120	18	0.535	ML 71917	110.0	93.0	96.0	114.0	1.1	0.6	99.2	1.94	8.731	29
	130	22	0.927	ML 7017	116.5	98.5	99.5	121.5	1.1	0.6	103.4	2.49	11.113	25
90	125	18	0.562	ML 71918	115.0	98.5	101.0	119.0	1.1	0.6	104.2	1.94	8.731	31
	140	24	1.192	ML 7018	124.5	103.0	106.5	130.0	1.5	0.6	110.5	2.64	11.906	25
95	130	18	0.591	ML 71919	120.0	103.5	106.0	124.0	1.1	0.6	109.2	1.94	8.731	32
	145	24	1.263	ML 7019	129.5	109.5	111.5	135.0	1.5	0.6	115.5	2.64	11.906	26
100	140	20	0.796	ML 71920	128.5	109.5	112.5	133.0	1.1	0.6	115.9	2.02	10.319	29
	150	24	1.313	ML 7020	134.5	114.5	116.5	140.0	1.5	0.6	120.5	2.61	11.906	27
105	160	26	1.602	ML 7021	143.0	119.0	123.0	149.0	2.0	1.0	127.5	3.02	13.494	25
110	150	20	0.868	ML 71922	138.5	119.5	122.5	143.0	1.1	0.6	125.9	1.98	10.319	32
	170	28	2.019	ML 7022	150.5	126.0	130.0	149.0	2.0	1.0	134.7	3.23	14.288	25
120	165	22	1.204	ML 71924	151.5	131.0	134.5	156.5	1.1	6.0	138.1	2.18	11.113	33
	180	28	2.167	ML 7024	160.5	136.0	140.0	167.5	2.0	1.0	144.7	3.23	14.288	27
130	180	24	1.572	ML 71926	165.0	142.0	146.0	170.5	1.5	0.6	150.0	2.56	12.700	31
	200	33	3.306	ML 7026	177.0	148.5	154.0	185.0	2.0	1.0	158.9	3.84	16.669	26

■ MachLine, high speed and precision bearing for machine tools (*continued*)

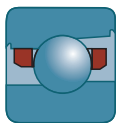

ML

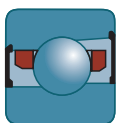

MLE

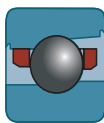

MLCH

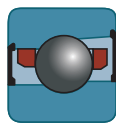

MLECH

Serie C	a mm	c N	C ₀ N			Serie H	a mm	c N	C ₀ N		
				rpm*	rpm*					rpm*	rpm*
ML 71914 CV	19	25 000	26 000	17 000	27 000	ML 71914 HV	28	23 700	24 300	15 000	23 500
ML 7014 CV	22	34 000	34 500	16 500	25 000	ML 7014 HV	31	32 000	32 500	15 000	21 800
ML 71915 CV	20	26 000	28 000	16 500	26 000	ML 71915 HV	29	24 600	26 000	14 000	21 700
ML 7015 CV	23	34 500	36 000	15 500	23 750	ML 7015 HV	32	32 500	34 000	13 500	21 000
ML 71916 CV	21	27 000	30 000	15 500	24 500	ML 71916 HV	30	25 500	28 000	13 700	21 000
ML 7016 CV	25	44 000	44 500	14 000	21 500	ML 7016 HV	35	41 500	42 500	12 500	19 000
ML 71917 CV	23	31 500	35 000	14 500	22 500	ML 71917 HV	33	29 500	32 500	12 500	20 000
ML 7017 CV	26	46 000	49 000	13 500	20 500	ML 7017 HV	36	43 500	46 000	11 500	18 500
ML 71918 CV	23	32 500	37 000	13 500	21 000	ML 71918 HV	34	30 500	34 500	11 700	18 700
ML 7018 CV	28	52 000	56 000	12 500	19 100	ML 7018 HV	39	49 000	53 000	10 500	17 200
ML 71919 CV	24	33 000	38 000	12 700	20 000	ML 71919 HV	35	31 000	35 500	11 000	17 700
ML 7019 CV	28	53 000	59 000	12 000	18 400	ML 7019 HV	40	50 000	55 000	10 000	16 500
ML 71920 CV	26	42 500	49 000	11 700	18 500	ML 71920 HV	38	40 000	45 500	10 500	16 700
ML 7020 CV	29	54 000	61 000	11 500	18 000	ML 7020 HV	41	51 000	57 000	9 500	15 900
ML 7021 CV	31	65 000	72 000	10 500	16 500	ML 7021 HV	44	61 000	68 000	9 000	14 900
ML 71922 CV	28	44 500	53 000	10 500	17 000	ML 71922 HV	41	42 000	50 000	9 300	14 700
ML 7022 CV	33	72 000	81 000	10 000	15 800	ML 7022 HV	47	68 000	76 000	8 500	13 900
ML 71924 CV	30	52 000	64 000	9 500	15 500	ML 71924 HV	44	49 000	60 000	8 600	13 500
ML 7024 CV	34	75 000	88 000	9 000	14 000	ML 7024 HV	49	70 000	82 000	8 000	12 500
ML 71926 CV	33	64 000	79 000	8 500	14 000	ML 71926 HV	48	60 000	73 000	7 500	11 500
ML 7026 CV	39	97 000	115 000	8 000	12 500	ML 7026 HV	55	92 000	108 000	7 000	10 500

* These are the speed limits according to the SNR concept (see pages 85 to 87).

Double-row ball bearings



Radial double-row ball bearings	262
■ Definition and capabilities	262
■ Series	262
■ Tolerances and clearances	262
■ Design criteria	263
■ Suffixes	263
■ Characteristics	264
<i>Radial double-row ball bearings</i>	265
Double-row angular-contact ball bearings	266
■ Definition and capabilities	266
■ Series	266
■ Variants	267
■ Tolerances and clearances	267
■ Design criteria	267
■ Suffixes	267
■ Characteristics	268
<i>Double-row angular-contact ball bearings</i>	269
<i>Double-row angular-contact ball bearings sealed and protected</i>	270
<i>Double-row angular-contact ball bearings protected with groove</i>	272
Double-row self-aligning ball bearings	274
■ Definition and capabilities	274
■ Series	275
■ Variants	275
■ Tolerances and clearances	277
■ Fitting and adjustment	277
■ Suffixes	277
■ Characteristics	278
<i>Double-row self-aligning ball bearings with cylindrical bore</i>	278
<i>Double-row self-aligning ball bearings with tapered bore with adapter sleeve</i>	282
<i>Double-row self-aligning ball bearings sealed</i>	286
<i>Double-row self-aligning ball bearings with wide inner ring</i>	288

Radial double-row ball bearings

Definition and capabilities

Radial double-row ball bearings are designed to sustain higher radial loads than single-row bearings, as well as axial loads in both directions.

Practically, these bearings only admit very low misalignment between shaft and housing, to the order of 0.06° .

Series

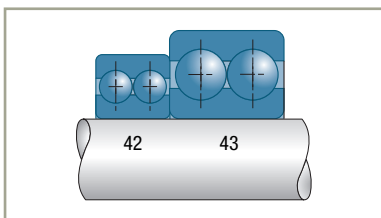

Tolerances and clearances

→ Tolerances

Normally manufactured in the normal tolerance class.

Single-row ball bearings can be supplied on request in tolerance classes 6 and 5 for all or specific characteristics (e.g. bore or radial run-out in tolerance class 6).

→ Internal radial clearance

All standard production bearings are in the normal clearance group N. The other groups can be supplied on request.

For single-row radial ball bearings with a tapered bore, SNR has adopted group 3 (C3) as the standard clearance to allow for the greater reduction in clearance resulting from fitting on a tapered seat.

The radial clearance leads to an axial clearance; a simple formula can be used to calculate the approximate size of the theoretical axial clearance J_a as a function of the operating radial clearance J_r .

$$J_a = (J_r (D-d) / 20)^{1/2}$$



Design criteria

■ Bearing life

■ Residual radial clearance

■ Bearings operating under high axial loads

The performance of bearings operating under high axial loads can be improved by increasing the radial clearance in order to create a contact angle in operation. The axial load F_a must not exceed a mean value of 0,5 C_0 .

This type of operation has to be studied according to the loading conditions and dimensions of the bearings. Consult SNR.

■ Assembly made up by two side-by-side bearings

Each pair of bearings is calculated like a single bearing.

Suffixes

A

Bearing without filling slots with glass-fiber reinforced polyamide cage 6.6

Radial double-row ball bearings (continued)

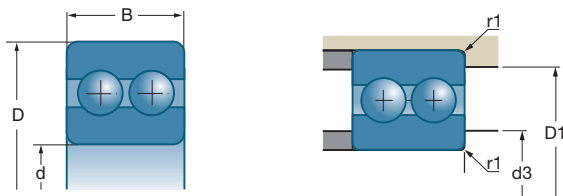



d		D	B				
				10°N	10°N	rpm*	rpm*
mm	References	mm	mm				
10	4200 A	30	14	9.2	5.2	18000	22000
12	4201 A	32	14	9.4	5.5	16000	20000
15	4202 A	35	14	10.4	6.6	14000	18000
	4302 A	42	17	14.8	9.1	12000	16000
17	4203 A	40	16	14.7	9.5	13000	16000
	4303 A	47	19	19.7	13.2	11000	14000
20	4204 A	47	18	17.8	12.7	11000	13000
	4304 A	52	21	23.4	16	9400	12000
25	4205 A	52	18	19.2	14.7	9400	12000
	4305 A	62	24	31.5	22.4	7800	10000
30	4206 A	62	20	26	20.7	7800	9800
	4306 A	72	27	39.5	30.5	6700	8800
35	4207 A	72	23	32	26	6700	8400
	4307 A	80	31	51	38	5900	7800
40	4208 A	80	23	34	30	6000	7500
	4308 A	90	33	63	48	5200	6900
45	4209 A	85	23	36	33	5500	6900
	4309 A	100	36	72	60	4700	6200
50	4210 A	90	23	39.8	36.5	5100	6400
	4310 A	110	40	89	76	4200	5600
55	4211 A	100	25	43	43	4600	5800
	4311 A	120	43	104	90	3900	5100
60	4212 A	110	28	57	58	4200	5300
	4312 A	130	46	120	106	3600	4700
65	4213 A	120	31	67	67	3900	4900
	4313 A	140	48	129	113	3300	4400
70	4214 A	125	31	70	73	3700	4600
75	4215 A	130	31	73	80	3500	4400
80	4216 A	140	33	81	90	3300	4100
85	4217 A	150	36	94	106	3100	3800

* These are the speed limits according to the SNR concept (see pages 85 to 87).

Design criteria

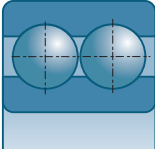
■ Radial double-row ball bearings

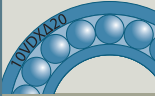

	d3 min	D1 max	r1 max	
References	mm	mm	mm	kg
4200 A	14	26	0.6	0.049
4201 A	16	28	0.6	0.055
4202 A 4302 A	19 21	31 36	0.6 1	0.060 0.120
4203 A 4303 A	21 23	36 41	0.6 1	0.090 0.160
4204 A 4304 A	26 27	41 45	1 1.1	0.140 0.210
4205 A 4305 A	31 32	46 55	1 1.1	0.160 0.340
4206 A 4306 A	36 37	56 65	1 1.1	0.260 0.541
4207 A 4307 A	42 44	65 71	1.1 1.5	0.434 0.732
4208A 4308A	47 49	73 81	1.1 1.5	0.531 1.006
4209 A 4309 A	52 54	78 91	1.1 1.5	0.581 1.348
4210 A 4310 A	57 61	83 99	1.1 2	0.623 1.800
4211 A 4311 A	64 66	91 109	1.5 2	0.839 2.275
4212 A 4312 A	69 73	101 117	1.5 2.1	1.153 2.890
4213 A 4313 A	74 78	111 127	1.5 2.1	1.615 3.460
4214 A	79	116	1.5	1.715
4215 A	84	121	1.5	1.810
4216 A	91	129	2	2.280
4217 A	96	139	2	2.500

Double-row angular-contact ball bearings

Definition and capabilities

→ Definition

Double-row angular-contact ball bearings accept axial loads in both directions and can be used singly, as dual bearing units.

→ Capabilities

■ Loads and speeds

These bearings are designed to:

- withstand combined loads with a predominant axial component

$$F_a / F_r \geq 1$$

- withstand axial loads in both directions
- accept relatively high speeds of rotation

■ Misalignment

The construction of these bearings limits them to very small misalignment values, in the range of 0.06°.

Series

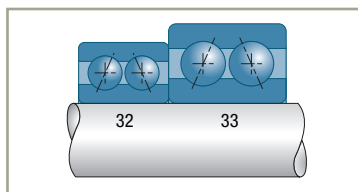

■ Series 32...A, 33...A

Contact angle 25°.

No filling slot.

Can accept axial loads in both directions.

These bearings have synthetic material cages.

They are supplied pre-lubricated with a standard application grease (maximum operating temperature 110°C or 230°F).

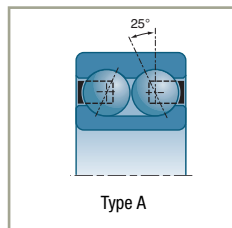

■ Series 32...B, 33...B

Contact angle 32°.

With filling slots.

Can accept axial loads (higher loads than Type A) in a predominant direction.

Cage in pressed steel, synthetic material or machined brass.

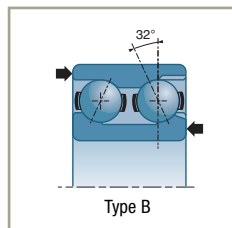

Variants

■ Sealed or protected bearings

Double-row angular-contact ball bearings also exist in variants fitted with shields or seals. In this case their reference becomes 52... ZZ, 53... ZZ or 52... EE, 53... EE.

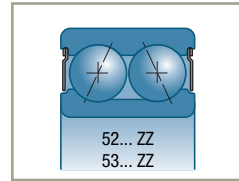

The outer ring of bearings in the series with seals or shields can be fitted with a snap ring (reference 52...NRZZ, 53 ... NREE). The position dimensions of the snap ring are identical to those of the ball bearing with the same outside diameter.

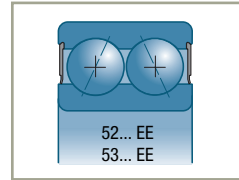

Tolerances and clearances

→ Tolerances

Manufactured in the normal tolerance class.

→ Axial clearance

An axial clearance is defined for these bearings. This clearance is not standardised. The values are communicated by SNR on request.

The relation between the radial clearance J_r of a bearing and the axial clearance J_a defined above can be approximated using the following formula:

Type A:

$$J_r = 0.4 J_a$$

Type B:

$$J_r = 0.5 J_a$$

Installation/assembly criteria

In the majority of applications this bearing is considered a single assembly. It can sometimes be used like a double bearing playing the role of two bearings due to the distance between the load application points.

Suffixes

A	No filling slot with polyamide cage, angle 25°
B	With filling slots, angle 32°
G15	Glass-fiber reinforced polyamide cage

Double-row angular-contact ball bearings (continued)

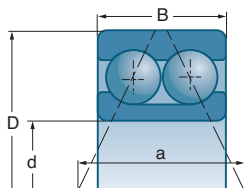

version A

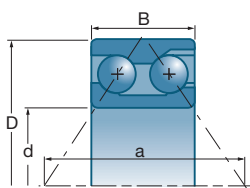

version B

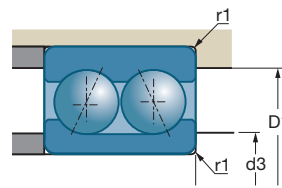



d		D	B	a				
mm	References	mm	mm	mm	10°N	10°N	rpm*	rpm*
10	3200 A	30	14	15.1	7.8	4.55	16000	21000
12	3201 A	32	15.9	16.6	10.7	5.9	15000	20000
15	3202 A 3302 A	35	15.9	18	11.8	7.1	13000	18000
		42	19	21.5	16.2	10.1	11000	15000
17	3203 A 3303 A	40	17.5	20.4	14.6	9	12000	15000
		47	22.2	24	20.9	12.4	10000	14000
20	3204 A 3304 B	47	20.6	24.2	19.6	12.5	9700	13000
		52	22.2	34	20.8	18.3	9000	12000
25	3205 B 3305 B	52	20.6	35	18.9	18.2	8400	11000
		62	25.4	40	29	26.5	7500	10000
30	3206 B 3306 B	62	23.8	40.6	27	27	7200	9600
		72	30.2	47.3	38	36	6400	8600
35	3207 B 3307 B	72	27	47.2	37	37.5	6100	8200
		80	34.9	54.1	48.5	47	5600	7500
40	3208 B 3308 B	80	30.2	52	42	44	5500	7300
		90	36.5	59	60	59	5100	6800
45	3209 A 3309 A	85	30.2	43.2	48	37	5100	6800
		100	39.7	50.1	68	51	4600	6100
50	3210 A 3310 A	90	30.2	45.5	51	42	4700	6300
		110	44.4	55	81	62	4200	5600
55	3211 A 3311 A 3311 B	100	33.3	49.9	63	52	4300	5700
		120	49.2	61.2	102	79	3800	5100
		120	49.2	80.4	101	113	3800	5100
60	3212 A 3312 A	110	36.5	55.1	72	61	3900	5200
		130	54	67.3	125	98	3500	4600
65	3213 A 3313 A	120	38.1	59.8	80	73	3500	4700
		140	58.7	73.3	149	118	3200	4300
70	3214 A 3314 B	125	39.7	61.6	84	76	3400	4600
		150	63.5	100.8	147	172	3000	4000
75	3215 A	130	41.3	65	77	84	3200	4200
80	3216 A	140	44.4	69	99	93	3000	4000

* These are the speed limits according to the SNR concept (see pages 85 to 87).

Characteristics

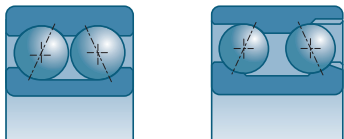
■ Double-row angular-contact ball bearings

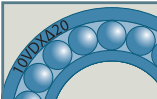

	d3 min	D1 max	r1 max	
	mm	mm	mm	kg
3200 A	15	25	0,6	0,043
3201 A	17	27	0,6	0,051
3202 A 3302 A	20 21	30 36	0,6 1	0,058 0,112
3203 A 3303 A	22 23	35 41	0,6 1	0,085 0,161
3204 A 3304 B	26 27	41 45	1 1	0,139 0,230
3205 B 3305 B	31 32	46 55	1 1	0,190 0,370
3206 B 3306 B	36 37	56 65	1 1	0,310 0,580
3207 B 3307 B	42 44	65 71	1 1,5	0,480 0,780
3208 B 3308 B	47 49	73 81	1 1,5	0,650 1,050
3209 A 3309 A	52 54	78 91	1 1,5	0,583 1,210
3210 A 3310 A	57 60	83 100	1 2	0,760 1,600
3211 A 3311 A 3311 B	64 65 65	91 110 110	1,5 2 2	0,876 2,110 2,530
3212 A 3312 A	69 73	101 118	1,5 2	1,180 2,700
3213 A 3313 A	74 78	111 128	1,5 2	1,520 3,390
3214 A 3314 B	79 83	116 138	1,5 2	1,520 5,050
3215 A	84	121	1,5	1,910
3216 A	91	129	2	2,450

Double-row angular-contact ball bearings (continued)

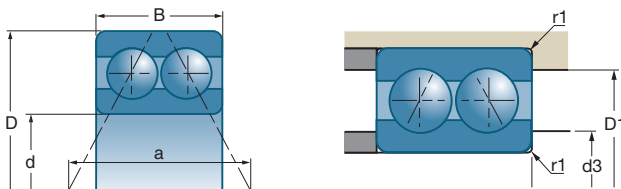



d		D	B	a					
							mm	References	mm
12	5201 EE 5201 ZZ	32	15.9	16.6	10.7	5.9	15000	15000	
15	5202 EE 5202 ZZ	35	15.9	18	11.8	7.1	13000	13000	
	5302 EE	42	19	21.5	16.2	10.1	11000	11000	
17	5203 EE 5203 ZZ	40	17.5	20.4	14.6	9	12000	12000	
	5303 EE 5303 ZZ	47	22.2	24	20.9	12.4	10000	10000	
20	5204 EE 5204 ZZ	47	20.6	24.2	19.6	12.5	9700	9700	
	5304 EE 5304 ZZ	52	22.2	26.4	23.3	15.1	8900	8900	
25	5205 EE 5205 ZZ	52	20.6	26.5	21.3	14.7	8400	8400	
	5305 EE 5305 ZZ	62	25.4	30.7	30	19.9	7600	7600	
30	5206 EE 5206 ZZ	62	23.8	31.4	29.5	21.1	7100	7100	
	5306 EE 5306 ZZ	72	30.2	36.2	41.5	28.5	6500	6500	
35	5207 EE 5207 ZZ	72	27	36.5	39	28.5	6200	6200	
	5307 EE 5307 ZZ	80	34.9	41.5	51	34.5	5700	5700	
40	5208 EE 5208 ZZ	80	30.2	40.9	48	36.5	5500	5500	
	5308 EE 5308 ZZ	90	36.5	45.8	62	45	5100	5100	
45	5209 EE 5209 ZZ	85	30.2	43.2	48	37	5100	5100	
	5309 EE 5309 ZZ	100	39.7	50.1	68	51	4600	4600	
50	5210 EE 5210 ZZ	90	30.2	45.5	51	42	4700	4700	
	5310 EE 5310 ZZ	110	44.4	55	81	62	4200	4200	
55	5211 EE 5211 ZZ	100	33.3	49.9	59	49.5	2800	4300	
	5311 ZZ	120	49.2	61.2	102	79	3800	3800	
60	5212 EE 5212 ZZ	110	36.5	55.1	72	61	2500	3900	
	5312 ZZ	130	54	67.3	125	98	3500	3500	
65	5213 EE 5213 ZZ	120	38.1	59.8	80	73	3500	3500	
	5313 ZZ	140	58.7	73.3	149	118	3200	3200	
70	5214 EE 5214 ZZ	125	39.7	61.6	84	76	2200	3400	

* These are the speed limits according to the SNR concept (see pages 85 to 87).

Characteristics

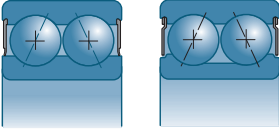
■ Double-row angular-contact ball bearings sealed and protected

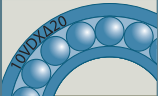

	d3 min	D1 max	r1 max	
References	mm	mm	mm	kg
5201 EE 5201 ZZ	17	27	0,6	0,051
5202 EE 5202 ZZ 5302 EE	20 21	30 36	0,6 1	0,058 0,112
5203 EE 5203 ZZ 5303 EE 5303 ZZ	22 23	35 41	0,6 1	0,085 0,161
5204 EE 5204 ZZ 5304 EE 5304 ZZ	26 27	41 45	1 1	0,140 0,200
5205 EE 5205 ZZ 5305 EE 5305 ZZ	31 32	46 55	1 1	0,160 0,320
5206 EE 5206 ZZ 5306 EE 5306 ZZ	36 37	56 65	1 1,1	0,265 0,510
5207 EE 5207 ZZ 5307 EE 5307 ZZ	42 44	65 71	1,1 1,5	0,430 0,790
5208 EE 5208 ZZ 5308 EE 5308 ZZ	47 49	73 81	1,1 1,5	0,570 1,050
5209 EE 5209 ZZ 5309 EE 5309 ZZ	52 54	78 91	1,1 1,5	0,620 1,420
5210 EE 5210 ZZ 5310 EE 5310 ZZ	57 60	83 100	1,1 2	0,800 1,930
5211 EE 5211 ZZ 5311 EE 5311 ZZ	64 6	91 110	1,5 2	0,876 2,110
5212 EE 5212 ZZ 5312 EE 5312 ZZ	69 73	101 118	1,5 2,1	1,180 2,700
5213 EE 5213 ZZ 5313 EE 5313 ZZ	74 78	111 128	1,5 2,1	1,520 3,390
5214 EE 5214 ZZ	79	116	1,5	1,640

Double-row angular-contact ball bearings (continued)

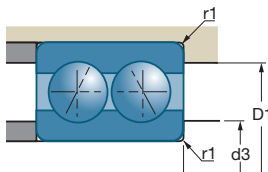
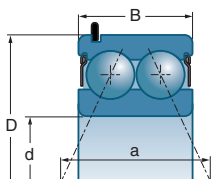



d		D	B	a			
mm	References	mm	mm	mm	10°N	10°N	rpm*
15	5202 NRZZ	35	15.9	18	11.8	7.1	13000
17	5203 NRZZ	40	17.5	20.4	14.6	9	12000
	5303 NRZZ	47	22.2	24	20.9	12.4	10000
20	5204 NRZZ	47	20.6	24.2	19.6	12.5	9700
	5304 NRZZ	52	22.2	26.4	23.3	15.1	8900
25	5205 NRZZ	52	20.6	26.5	21.3	14.7	8400
	5305 NRZZ	62	25.4	30.7	30	19.9	7600
30	5206 NRZZ	62	23.8	31.4	29.5	21.1	7100
	5306 NRZZ	72	30.2	36.2	41.5	28.5	6500
35	5207 NRZZ	72	27	36.5	39	28.5	6200
	5307 NRZZ	80	34.9	41.5	51	34.5	5700
40	5208 NRZZ	80	30.2	40.9	48	36.5	5500
	5308 NRZZ	90	36.5	45.8	62	45	5100
45	5209 NRZZ	85	30.2	43.2	48	37	5100
	5309 NRZZ	100	39.7	50.1	68	51	4600
50	5210 NRZZ	90	30.2	45.5	51	42	4700
	5310 NRZZ	110	44.4	55	81	62	4200
55	5211 NRZZ	100	33.3	49.9	59	49.5	4300
	5311 NRZZ	120	49.2	61.2	102	79	3800
60	5212 NRZZ	110	36.5	55.1	72	61	3900
	5312 NRZZ	130	54	67.3	125	98	3500
65	5213 NRZZ	120	38.1	59.8	80	73	3500
	5313 NRZZ	140	58.7	73.3	149	118	3200
70	5214 NRZZ	125	39.7	61.6	84	76	3400

* These are the speed limits according to the SNR concept (see pages 85 to 87).

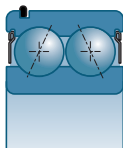
■ Double-row angular-contact ball bearings protected with snap ring



	d3 min	D1 max	r1 max	segment	
References	mm	mm	mm		kg
5202 NRZZ	20	30	0,6	R35	0,058
5203 NRZZ	22	35	0,6	R40	0,100
5303 NRZZ	23	41	1	R47	0,190
5204 NRZZ	26	41	1	R47	0,140
5304 NRZZ	27	45	1	R52	0,200
5205 NRZZ	31	46	1	R52	0,160
5305 NRZZ	32	55	1	R62	0,320
5206 NRZZ	36	56	1	R62	0,265
5306 NRZZ	37	65	1,1	R72	0,590
5207 NRZZ	42	65	1,1	R72	0,480
5307 NRZZ	44	71	1,5	R80	0,820
5208 NRZZ	47	73	1,1	R80	0,650
5308 NRZZ	49	81	1,5	R90	1,050
5209 NRZZ	52	78	1,1	R85	0,710
5309 NRZZ	54	91	1,5	R100	1,340
5210 NRZZ	57	83	1,1	R90	0,760
5310 NRZZ	60	100	2	R11	1,720
5211 NRZZ	64	91	1,5	R100	0,876
5311 NRZZ	65	110	2	R120	2,110
5212 NRZZ	69	101	1,5	R110	1,180
5312 NRZZ	73	118	2,1	R130	2,700
5213 NRZZ	74	111	1,5	R120	1,520
5313 NRZZ	78	128	2,1	R140	3,390
5214 NRZZ	79	116	1,5	R125	1,640

Double-row self-aligning ball bearings

Definition and capabilities

→ Definition

The spherical race in the outer ring allows angular displacement.

The variant with taper bore makes assembly easier.

■ Cages

Standard dimension bearings are equipped with a synthetic material cage (maximum operating temperature: 120°C or 248°F, 150°C or 302°F peak). Large dimension bearings are equipped with a pressed steel or machined brass cage.

→ Capabilities

■ Loads and speeds

This type of bearing accepts relatively high speeds of rotation. It has good ability to withstand radial loads. Its design, however, means that it can only accept very low axial loads.

■ Misalignment

The outer ring of this type of bearing has a spherical raceway that allows angular travel rings. This means that it can accept high misalignment values, whether permanent (rotational bending of shaft) or not.

Double-row self-aligning ball bearings allow high misalignment values of the order of 2 to 4° without loss of performance.

The misalignment angle must nevertheless be limited in order to remain within values compatible with the sealing system used.

In sealed variants the permissible misalignment is limited to 0.5°.

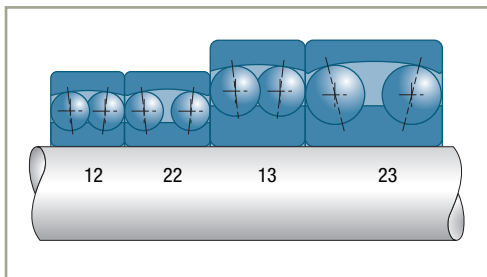

Variants

■ Bearings with tapered bore. Suffix K

Standardized 1:12 taper. They are usually fitted using a tapered adapter sleeve.

The tapered bore variant allows the use of as-rolled shafts, thanks to the characteristics of the tapered adapter sleeve. These bearings are often mounted in split pillow blocks.

■ Sealed bearings. Suffix EE. Series 22...EE - 23...EE

These bearings are pre-greased. Their seals limit angular travel possibilities to 1/20. Their basic loads are the same as the series 12 and 13 bearings of the same diameter, because they have the same internal design definition.

They therefore also have the same equivalent load factors.

■ Bearings with wide inner ring. Series 112, 113

Bearings whose inner ring extends beyond both sides of the outer ring. The inner ring has a slot for a drive screw. These bearings are mainly used in agricultural machinery.

Double-row self-aligning ball bearings (continued)

Tolerances and clearances

→ Tolerances

These bearings are supplied with tolerances in compliance with ISO 492 Standard, but in the normal tolerance class only.

→ Clearances

■ Internal radial clearance

This clearance is standardised (ISO 5753). The values are different for cylindrical bore and tapered bore bearings (suffix K). The latter have a significantly larger clearance to allow the reduction in clearance resulting from the adapter sleeve interference fit. The recommended residual clearance after fitting is of the range of:

$$J_{rm} = 2 d^{1/2} 10^{-3}$$

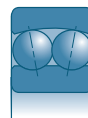

■ Double-row self-aligning ball bearings with cylindrical bore series 12-13-22-23-112-113

Bore diameter d (mm)	Group 2		Group N		Group 3		Group 4		Group 5	
	min	max	min	max	min	max	min	max	min	max
2,5 < d ≤ 6	1	8	5	15	10	20	15	25	21	33
6 < d ≤ 10	2	9	6	17	12	25	19	33	27	42
10 < d ≤ 18	2	10	6	19	13	26	21	35	30	48
14 < d ≤ 18	3	12	8	21	15	28	23	37	32	50
18 < d ≤ 24	4	14	10	23	17	30	25	39	34	52
24 < d ≤ 30	5	16	11	24	19	35	29	46	40	58
30 < d ≤ 40	6	18	13	29	23	40	34	53	46	66
40 < d ≤ 50	6	19	14	31	25	44	37	57	50	71
50 < d ≤ 65	7	21	16	36	30	50	45	69	62	88
65 < d ≤ 80	8	24	18	40	35	60	54	83	76	108
80 < d ≤ 100	9	27	22	48	42	70	64	96	89	124
100 < d ≤ 120	10	31	25	56	50	83	75	114	105	145
120 < d ≤ 140	10	38	30	68	60	100	90	135	125	175
140 < d ≤ 160	15	44	35	80	70	120	110	161	150	210

Value in µm

■ Bearings with tapered bore
series 12K-13K-22K-23K

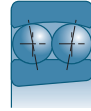

Bore diameter	Group 2		Group N		Group 3		Group 4		Group 5	
	d (mm)	min	max	min	max	min	max	min	max	min
18 <d≤ 24	7	17	13	26	20	33	28	42	37	55
24 <d≤ 30	9	20	15	28	23	39	33	50	44	62
30 <d≤ 40	12	24	19	35	29	46	40	59	52	72
40 <d≤ 50	14	27	22	39	33	52	45	65	58	79
50 <d≤ 65	18	32	27	47	41	61	56	80	73	99
65 <d≤ 80	23	39	35	57	50	75	69	98	91	123
80 <d≤ 100	29	47	42	68	62	90	84	116	109	144
100 <d≤ 120	35	56	50	81	75	108	100	139	130	170
120 <d≤ 140	40	68	60	98	90	130	120	165	155	205
140 <d≤ 160	45	74	65	110	100	150	140	191	180	240

Value in µm

■ Axial clearance

As the axial clearance J_a is a function of the radial clearance J_r , its value can be calculated using the following approximation formula:

$$J_a = 2.27 Y_0 \cdot J_r$$

Fitting and adjustment

This type of bearing is very sensitive to any cancellation of clearance and the residual clearance must be checked after fitting swivelling by hand. It is particularly important to perform this check on bearings with a tapered bore.



Some self-aligning ball bearings protrude slightly with respect to the faces. Example: 1320.

Suffixes

EE	Double sealing
G14, G15	Moulded polyamide cage
K	Tapered bore, 1:12 taper
M	Machined brass cage centred on the balls

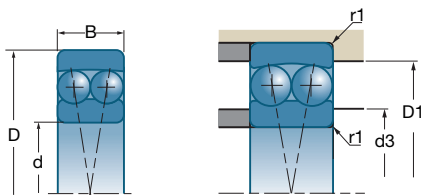
Double-row self-aligning ball bearings (continued)



d		D	B			e	Y		Yo
				10°N	10°N		Fa Fr ≤ e	Fa Fr > e	
mm	References	mm	mm	10°N	10°N				
10	1200 G15	30	9	5.50	1.19	0.31	2.00	3.10	2.00
	2200 G14	30	14	7.30	1.58	0.31	2.00	3.10	2.00
12	1201 G15	32	10	5.60	1.26	0.31	2.00	3.10	2.00
	2201 G15	32	14	7.50	1.71	0.31	2.00	3.10	2.00
	1301 G14	37	12	9.40	2.14	0.33	1.90	2.90	1.90
15	1202 G15	35	11	7.50	1.75	0.31	2.00	3.10	2.00
	2202 G15	35	14	9.20	2.08	0.31	2.00	3.10	2.00
	1302 G14	42	13	9.50	2.28	0.33	1.90	2.90	1.90
	2302 G15	42	17	16.30	3.85	0.42	1.47	2.28	1.55
17	1203 G15	40	12	7.90	2.03	0.31	2.00	3.10	2.00
	2203 G15	40	16	11.50	2.75	0.46	1.40	2.10	1.40
	1303 G14	47	14	12.50	3.20	0.33	1.90	2.90	1.90
	2303 G14	47	19	14.40	3.55	0.50	1.20	2.00	1.20
20	1204	47	14	9.70	2.65	0.26	2.40	3.60	2.40
	2204 G15	47	18	14.30	3.50	0.43	1.50	2.30	1.50
	1304 G15	52	15	12.40	3.35	0.27	2.30	3.60	2.40
25	1205	52	15	11.90	3.30	0.27	2.30	3.60	2.40
	2205	52	18	12.20	3.45	0.42	1.50	2.40	1.60
	2205 G15	52	18	16.90	4.45	0.42	1.50	2.40	1.60
	1305 G15	62	17	18.00	5.00	0.27	2.30	3.60	2.40
	2305 G15	62	24	24.40	6.50	0.47	1.40	2.10	1.40
30	1206	62	16	15.40	4.70	0.24	2.60	4.00	2.70
	2206	62	20	15.00	4.60	0.36	1.80	2.70	1.80
	1306	72	19	20.90	6.30	0.24	2.60	4.00	2.70
	2306	72	27	30.50	8.70	0.43	1.40	2.30	1.50
35	1207	72	17	15.60	5.10	0.22	2.90	4.50	3.00
	2207	72	23	21.20	6.70	0.36	1.80	2.70	1.90
	1307 G15	80	21	25.00	7.90	0.24	2.60	4.00	2.70
	2307 G15	80	31	39.50	11.10	0.46	1.40	2.10	1.40
40	1208	80	18	19.00	6.50	0.21	2.90	4.60	3.10
	2208 G15	80	23	31.50	9.50	0.25	2.60	4.00	2.70
	1308	90	23	29.00	9.80	0.24	2.60	4.00	2.80
	2308 G15	90	33	45.00	13.40	0.44	1.50	2.20	1.50
45	1209	85	19	21.50	7.40	0.21	2.90	4.60	3.10
	2209	85	23	23.00	8.20	0.29	2.10	3.30	2.20
	1309	100	25	37.50	12.90	0.24	2.60	4.00	2.70
	2309 G15	100	36	54.00	16.40	0.44	1.50	2.20	1.50

Characteristics

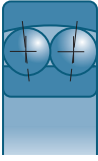

■ Double-row self-aligning ball bearings with cylindrical bore

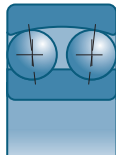

12../23..



22../23..

References	 rpm*	 rpm*	d3 min mm	D1 max mm	r1 max mm	 kg
1200 G15 2200 G14	24000 24000	29000 29000	14.0 14.0	26.0 27.0	0.6 0.6	0.032 0.048
1201 G15 2201 G15 1301 G14	23000 22000 18000	27000 26000 22000	16.0 16.0 17.0	28.0 28.0 31.0	0.6 0.6 1.0	0.041 0.055 0.073
1202 G15 2202 G15 1302 G14 2302 G15	20000 19000 16000 15000	23000 23000 19000 17000	19.0 19.0 20.0 20.0	31.0 31.0 36.0 36.0	0.6 0.6 1.0 1.0	0.050 0.063 0.097 0.115
1203 G15 2203 G15 1303 G14 2303 G14	17000 16000 14000 13000	21000 19000 17000 16000	21.0 21.0 22.0 22.0	36.0 36.0 41.0 41.0	0.6 0.6 1.1 1.1	0.073 0.088 0.128 0.157
1204 2204 G15 1304 G15	14000 14000 12000	17000 16000 14000	25.0 25.0 26.5	42.0 42.0 47.0	1.0 1.0 1.1	0.118 0.140 0.160
1205 2205 2205 G15 1305 G15 2305 G15	12000 12000 12000 10000 9600	15000 14000 14000 12000 11000	30.0 30.0 30.0 31.5 31.5	47.0 46.0 47.0 55.0 55.0	1.0 1.0 1.0 1.1 1.1	0.138 0.163 0.160 0.280 0.340
1206 2206 1306 2306	10000 10000 8500 8100	12000 12000 10000 9000	35.0 35.0 36.5 36.5	57.0 56.0 65.0 65.0	1.0 1.0 1.1 1.1	0.221 0.260 0.387 0.500
1207 2207 1307 G15 2307 G15	9000 8800 7400 7200	10000 10000 9000 8600	41.5 41.5 43.0 43.0	65.0 65.0 72.0 71.0	1.1 1.1 1.5 1.5	0.323 0.403 0.510 0.680
1208 2208 G15 1308 2308 G15	7900 7700 6600 6400	9400 9200 8000 7700	46.5 46.5 48.0 48.0	73.0 73.0 82.0 81.0	1.1 1.1 1.5 1.5	0.417 0.550 0.715 0.919
1209 2209 1309 2309 G15	7400 7200 6000 5700	8800 8600 7000 6800	51.5 51.5 53.0 53.0	78.0 78.0 92.0 91.0	1.1 1.1 1.5 1.5	0.465 0.550 0.957 1.229

* These are the speed limits according to the SNR concept (see pages 85 to 87).

Double-row self-aligning ball bearings (continued)

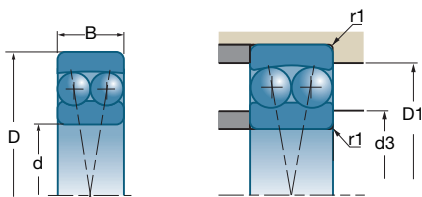

d		D	B			e	Y		Yo
							$\frac{F_a}{F_r} \leq e$	$\frac{F_a}{F_r} > e$	
mm	References	mm	mm	10°N	10°N				
50	1210	90	20	22.50	8.10	0.19	3.30	5.10	3.50
	2210	90	23	23.00	8.50	0.27	2.30	3.60	2.40
	1310 G15	110	27	41.50	14.30	0.24	2.60	4.10	2.80
	2310 G15	110	40	65.00	20.10	0.44	1.50	2.20	1.50
55	1211	100	21	26.50	10.00	0.19	3.40	5.20	3.50
	2211	100	25	26.50	9.90	0.27	2.30	3.60	2.30
	1311 G15	120	29	51.00	18.00	0.23	2.80	4.30	2.80
	2311 G15	120	43	75.00	23.80	0.44	1.50	2.20	1.50
60	1212 G15	110	22	30.00	11.60	0.18	3.60	5.50	3.60
	2212	110	28	34.00	12.50	0.27	2.30	3.60	2.30
	1312	130	31	57.00	20.70	0.23	2.80	4.30	2.80
	2312 G15	130	46	87.00	28.00	0.40	1.60	2.50	1.60
65	1213	120	23	31.00	12.40	0.18	3.60	5.50	3.60
	2213	120	31	43.50	16.40	0.27	2.30	3.60	2.30
	2313 G15	140	48	96.00	32.50	0.40	1.60	2.50	1.60
70	2214	125	31	44.00	17.00	0.27	2.30	3.60	2.30
	2314	150	51	109.00	37.50	0.40	1.60	2.50	1.60
75	1215	130	25	39.00	15.50	0.18	3.60	5.50	3.60
	2215	130	31	44.50	17.90	0.25	2.50	3.80	2.50
	1315	160	37	79.00	30.00	0.23	2.80	4.30	2.80
	2315	160	55	123.00	42.50	0.40	1.60	2.50	1.60
80	1216	140	26	40.00	16.90	0.18	3.60	5.50	3.60
	2216	140	33	49.00	20.00	0.25	2.50	3.80	2.50
85	1217	150	28	49.00	20.40	0.18	3.60	5.50	3.60
	1317	180	41	98.00	38.00	0.23	2.80	4.30	2.80
90	1218	160	30	57.00	23.50	0.18	3.60	5.50	3.60
	2218	160	40	69.00	28.50	0.27	2.40	3.70	2.50
	2318	190	64	149.00	58.00	0.37	1.70	2.60	1.80
95	1219	170	32	64.00	27.00	0.18	3.60	5.50	3.60
100	1220	180	34	69.00	29.50	0.18	3.60	5.50	3.60
	2220	180	46	96.00	40.50	0.26	2.40	3.60	2.50
	1320	215	47	143.00	58.00	0.23	2.80	4.30	2.80
110	1222	200	38	88.00	38.50	0.18	3.60	5.50	3.60

■ Double-row self-aligning ball bearings with cylindrical bore (continued)

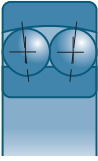

12../23..

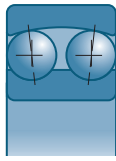





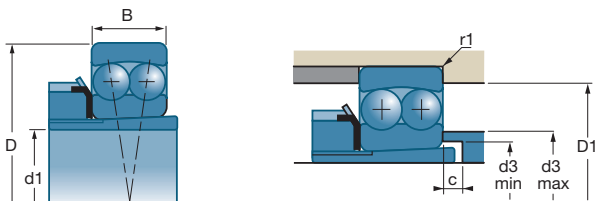

22../23..

References	LUBRICATION		d3 min	D1 max	r1 max	kg
	rpm*	rpm*	mm	mm	mm	
1210 2210 1310 G15 2310 G15	6900 6700 5400 5200	8200 8000 6500 6200	56.5 56.5 59.0 59.0	83.0 83.0 99.0 99.0	1.1 1.1 2.0 2.0	0.525 0.590 1.200 1.623
1211 2211 1311 G15 2311 G15	6100 6100 5000 4700	7300 7200 6000 5600	63.0 63.0 64.0 64.0	92.0 91.0 109.0 109.0	1.5 1.5 2.0 2.0	0.697 0.788 1.640 2.070
1212 G15 2212 1312 2312 G15	5700 5600 4600 4300	6700 6600 5600 5200	68.0 68.0 71.0 71.0	102.0 101.0 117.0 117.0	1.5 1.5 2.1 2.1	0.890 1.079 1.952 2.600
1213 2213 2313 G15	5200 5100 4000	6200 6000 4800	73.0 73.0 76.0	111.0 111.0 123.0	1.5 1.5 2.1	1.133 1.470 3.171
2214 2314	4800 3700	5700 4400	78.0 81.0	116.0 137.0	1.5 2.1	1.550 4.170
1215 2215 1315 2315	4700 4600 3700 3500	5600 5400 4400 4200	83.0 83.0 86.0 86.0	121.0 121.0 147.0 147.0	1.5 1.5 2.1 2.1	1.341 1.630 3.680 4.740
1216 2216	4400 4200	5200 5000	89.0 91.0	129.0 129.0	2.0 2.0	1.646 2.100
1217 1317	4100 3300	4800 4000	94.0 98.0	139.0 166.0	2.0 3.0	2.160 5.150
1218 2218 2318	3800 3700 2900	4500 4400 3500	99.0 99.0 103.0	149.0 151.0 177.0	2.0 2.0 3.0	2.500 3.190 7.840
1219	3600	4200	106.0	157.0	2.1	3.200
1220 2220 1320	3400 3300 2800	4000 4000 3400	111.0 111.0 113.0	167.0 169.0 201.0	2.1 2.1 3.0	3.700 4.680 8.700
1222	3100	3700	121.0	187.0	2.1	5.320

* These are the speed limits according to the SNR concept (see pages 85 to 87).

Double-row self-aligning ball bearings (continued)



d1		Sleeves	d	D	B	C1				
mm	References	References	mm	mm	mm	mm	10 ³ N	10 ³ N	rpm*	rpm*
20	1205 K	H205	25	52	15		11.90	3.30	12000	15000
	2205 K	H305	25	52	18		12.20	3.45	12000	14000
	1305 KG15	H305	25	62	17		18.00	5.00	10000	12000
	2305 KG15	H2305	25	62	24		24.40	6.50	9400	11000
25	1206 K	H206	30	62	16		15.40	4.70	10000	12000
	2206 K	H306	30	62	20		15.00	4.60	10000	12000
	1306 K	H306	30	72	19		21.30	6.30	8600	10000
	2306 K	H2306	30	72	27		30.50	8.70	8100	9000
30	1207 K	H207	35	72	17		15.60	5.10	9000	10000
	2207 K	H307	35	72	23		21.20	6.70	8800	10000
	1307 KG15	H307	35	80	21		25.00	7.90	7400	9000
	2307 KG15	H2307	35	80	31		39.50	11.10	7200	8600
35	1208 K	H208	40	80	18		19.00	6.50	7900	9400
	2208 KG15	H308	40	80	23		31.50	9.50	7700	9200
	1308 K	H308	40	90	23		29.00	9.80	6600	8000
	2308 K	H2308	40	90	33		45.00	13.40	6400	7700
40	1209 K	H209	45	85	19		21.50	7.40	7400	8800
	2209 K	H309	45	85	23		23.00	8.20	7200	8000
	1309 K	H309	45	100	25		37.50	12.90	6000	7000
	2309 K	H2309	45	100	36		54.00	16.40	5700	6800
45	1210 K	H210	50	90	20		22.50	8.10	6900	8200
	2210 K	H310	50	90	23		23.00	8.50	6700	8000
	1310 KG15	H310	50	110	27		41.50	14.30	5400	6500
	2310 K	H2310	50	110	40		65.00	20.10	5200	6200
50	1211 K	H211	55	100	21		26.50	10.00	6100	7300
	2211 K	H311	55	100	25		26.50	9.90	6100	7200
	1311 KG15	H311	55	120	29		51.00	18.00	5000	6000
	2311 K	H2311	55	120	43		75.00	23.80	4700	5600
55	1212 KG15	H212	60	110	22		30.00	11.60	5700	6700
	2212 K	H312	60	110	28		34.00	12.50	5500	6600
	1312 K	H312	60	130	31		57.00	20.70	4600	5600
	2312 K	H2312	60	130	46		87.00	28.00	4300	5200
60	1213 K	H213	65	120	23		31.00	12.40	5200	6200
	2213 K	H313	65	120	31		43.50	16.40	5100	6000
	2313 K	H2313	65	140	48		96.00	32.50	4000	4800

* These are the speed limits according to the SNR concept (see pages 85 to 87).



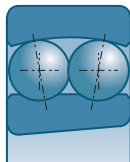

■ Double-row self-aligning ball bearings with tapered bore with adapter sleeve

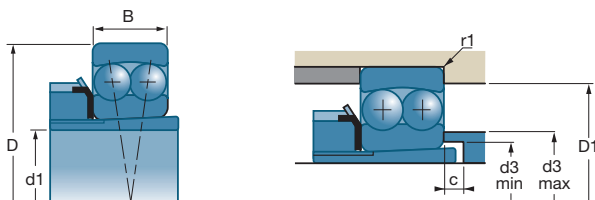

References	Sleeves	e	Y		Yo	d3 max	d3 min	c	D1 max	r1 max	
			$\frac{Fa}{Fr} \leq e$	$\frac{Fa}{Fr} > e$							
References	References					mm	mm	mm	mm	mm	kg
1205 K 2205 K 1305 KG15 2305 KG15	H205 H305 H305 H2305	0.27 0.42 0.27 0.48	2.3 1.5 2.3 1.3	3.6 2.4 3.6 2.0	2.4 1.6 2.4 1.4	32 33 37 36	28 28 28 30	5 5 6 5	47 46 55 55	1.0 1.0 1.1 1.1	0.139 0.164 0.280 0.328
1206 K 2206 K 1306 K 2306 K	H206 H306 H306 H2306	0.24 0.38 0.26 0.43	2.6 1.7 2.4 1.4	4.0 2.6 3.8 2.3	2.7 1.7 2.4 1.5	39 40 43 43	33 33 33 35	5 5 6 5	57 56 65 65	1.0 1.0 1.5 1.1	0.220 0.260 0.408 0.500
1207 K 2207 K 1307 KG15 2307 KG15	H207 H307 H307 H2307	0.22 0.36 0.24 0.46	2.9 1.8 2.6 1.4	4.5 2.7 4.0 2.1	3.0 1.9 2.7 1.4	46 47 51 48	38 39 39 40	5 5 8 5	65 65 72 71	1.1 1.1 1.5 1.5	0.322 0.401 0.510 0.680
1208 K 2208 KG15 1308 K 2308 K	H208 H308 H308 H2308	0.21 0.25 0.24 0.44	2.9 2.6 2.6 1.5	4.6 4.0 4.0 2.2	3.1 2.7 2.8 1.5	53 53 57 55	43 44 44 45	5 5 5 5	73 73 82 81	1.1 1.1 1.5 1.5	0.417 0.550 0.715 0.930
1209 K 2209 K 1309 K 2309 K	H209 H309 H309 H2309	0.21 0.29 0.24 0.44	2.9 2.1 2.6 1.5	4.6 3.3 4.0 2.2	3.1 2.2 2.7 1.5	57 58 63 62	48 50 50 50	5 8 5 5	78 78 92 91	1.1 1.1 1.5 1.5	0.465 0.550 0.959 1.250
1210 K 2210 K 1310 KG15 2310 K	H210 H310 H310 H2310	0.19 0.27 0.24 0.44	3.3 2.3 2.6 1.5	5.1 3.6 4.1 2.2	3.5 2.4 2.8 1.5	61 63 69 67	53 55 55 56	5 10 5 5	83 83 99 99	1.1 1.1 2.0 2.0	0.525 0.584 1.200 1.650
1211 K 2211 K 1311 KG15 2311 K	H211 H311 H311 H2311	0.19 0.27 0.23 0.44	3.4 2.3 2.8 1.5	5.2 3.6 4.3 2.2	3.5 2.3 2.8 1.5	68 70 76 74	60 60 60 61	6 10 6 6	92 91 109 109	1.5 1.5 2.0 2.0	0.697 0.773 1.550 2.260
1212 KG15 2212 K 1312 K 2312 K	H212 H312 H312 H2312	0.18 0.27 0.23 0.4	3.6 2.3 2.8 1.6	5.5 3.6 4.3 2.5	3.6 2.3 2.8 1.6	76 77 85 75	64 65 65 66	5 8 5 5	102 101 117 117	1.5 1.5 2.1 2.1	0.890 1.079 1.952 2.600
1213 K 2213 K 2313 K	H213 H313 H2313	0.18 0.27 0.4	3.6 2.3 1.6	5.5 3.6 2.5	3.6 2.3 1.6	84 83 88	70 70 72	5 8 5	111 111 127	1.5 1.5 2.1	1.124 1.419 3.170

Double-row self-aligning ball bearings (continued)



d1		Sleeves	d	D	B	C1				
mm	References	References	mm	mm	mm	mm	10 ³ N	10 ³ N	rpm*	rpm*
65	1215K	H215	75	130	25		39.00	15.50	4700	5600
	2215K	H315	75	130	31		44.50	17.90	4500	5400
	1315K	H315	75	160	37		79.00	30.00	3800	4500
	2315K	H2315	75	160	55		123.00	42.50	3500	4200
70	1216K	H216	80	140	26		40.00	16.90	4400	5200
	2216K	H316	80	140	33		49.00	20.00	4200	5100
75	1217K	H217	85	150	28		49.00	20.40	4100	4800
	1317K	H317	85	180	41		94.00	37.00	3300	4000
80	1218K	H218	90	160	30		57.00	23.50	3800	4600
	2218K	H318	90	160	40		69.00	28.50	3700	4000
	2318K	H2318	90	190	64		149.00	58.00	2900	3000
85	1219K	H219	95	170	32		64.00	27.00	3600	4300
90	1220K	H220	100	180	34		69.00	29.50	3400	4000
	2220K	H320	100	180	46		96.00	40.50	3300	4000
	1320K	H320	100	215	47	2.5	143.00	58.00	2800	3400
100	1222K	H222	110	200	38		88.00	38.50	3100	3700

* These are the speed limits according to the SNR concept (see pages 85 to 87).

■ Double-row self-aligning ball bearings with tapered bore with adapter sleeve (continued)

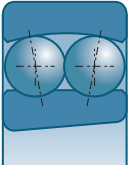

References	Sleeves	e	Y		Yo	d3 max	d3 min	c	D1 max	r1 max	
			$\frac{F_a}{F_r} \leq e$	$\frac{F_a}{F_r} > e$							
References	References					mm	mm	mm	mm	mm	kg
1215K	H215	0.18	3.6	5.5	3.6	92	80	5	121	1.5	1.324
2215K	H315	0.25	2.5	3.8	2.5	93	80	12	121	1.5	1.600
1315K	H315	0.23	2.8	4.3	2.8	102	80	5	147	2.1	3.690
2315K	H2315	0.4	1.6	2.5	1.6	101	82	5	147	2.1	4.700
1216K	H216	0.18	3.6	5.5	3.6	101	85	5	129	2.0	1.630
2216K	H316	0.25	2.5	3.8	2.5	100	85	12	129	2.0	2.100
1217K	H217	0.18	3.6	5.5	3.6	105	90	6	139	2.0	2.029
1317K	H317	0.23	2.8	4.3	2.8	115	91	6	166	3.0	5.150
1218K	H218	0.18	3.6	5.5	3.6	110	95	6	149	2.0	2.500
2218K	H318	0.27	2.4	3.7	2.5	112.3	96	10	151	2.0	3.190
2318K	H2318	0.37	1.7	2.6	1.8	112	100	7	177	3.0	7.840
1219K	H219	0.18	3.6	5.5	3.6	118	100	7	157	2.1	3.200
1220K	H220	0.18	3.6	5.5	3.6	125	106	7	167	2.1	3.790
2220K	H320	0.26	2.4	3.7	2.5	120	108	8	169	2.1	4.680
1320K	H320	0.23	2.8	4.3	2.8	135	108	7	201	3.0	8.300
1222K	H222	0.18	3.6	5.5	3.6	139	116	7	187	2.1	5.320

Double-row self-aligning ball bearings (continued)



d		D	B			e	Y		Yo
				$10^3 N$	$10^3 N$		$\frac{F_a}{F_r} \leq e$	$\frac{F_a}{F_r} > e$	
mm	References	mm	mm						
12	2201 EEG15	32	14	5.6	1.26	0.31	2	3.1	2
15	2202 EEG15	35	14	7.5	1.75	0.31	2	3.1	2
17	2203 EEG15 2303 EEG14	40	16	7.9	2	0.33	1.9	3	2
		47	19	12.5	3.2	0.32	1.9	3	2
20	2204 EEG15 2204 KEEG15 2304 EEG15	47	18	9.9	2.7	0.28	2.2	3.5	2.3
		52	21	12.4	3.4	0.29	2.2	3.3	2.3
25	2205 EEG15 2205 KEEG15 2305 EEG15	52	18	12.1	3.3	0.27	2.4	3.7	2.5
		62	24	18	5	0.28	2.3	3.5	2.4
30	2206 EEG15 2206 KEEG15 2306 EEG15	62	20	15.7	4.7	0.25	2.5	3.9	2.7
		72	27	21.3	6.3	0.26	2.4	3.7	2.5
35	2207 EEG15 2207 KEEG15 2307 EEG15	72	23	15.8	5.2	0.22	2.8	4.3	2.9
		80	31	25	7.9	0.26	2.5	3.8	2.6
40	2208 EEG15 2208 KEEG15 2308 EEG15	80	23	19.2	6.5	0.22	2.9	4.5	3
		90	33	29.5	9.8	0.25	2.5	3.9	2.6
45	2209 EEG15 2209 KEEG15 2309 EEG15	85	23	21.8	7.4	0.21	3	4.7	3.2
		100	36	38	12.9	0.25	2.5	3.9	2.6
50	2210 EEG15 2210 KEEG15 2310 EEG15	90	23	22.7	8.1	0.2	3.2	4.9	3.3
		110	40	41.5	14.3	0.24	2.6	4	2.7
55	2211 EEG15 2211 KEEG15	100	25	27	10	0.27	2.3	3.6	2.3
60	2212 EEG15	110	28	30	11.6	0.18	3.5	5.4	3.6

■ Double-row self-aligning ball bearings sealed

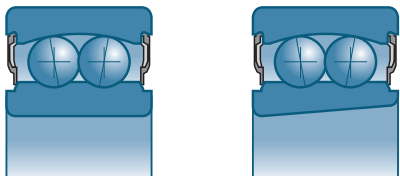

References	rpm*	d3 min mm	D1 max mm	r1 max mm	kg
2201 EEG15	17000	15	28.0	0.6	0.060
2202 EEG15	14000	19	31.0	0.6	0.070
2203 EEG15 2303 EEG14	12000 9800	21 22	36.0 42.0	0.6 1.0	0.103 0.179
2204 EEG15 2204 KEEG15 2304 EEG15	11000 8500	25 26	42.0 45.5	1.0 1.1	0.157 0.243
2205 EEG15 2205 KEEG15 2305 EEG15	9200 7100	30 31.5	47.0 55.5	1.0 1.1	0.174 0.385
2206 EEG15 2206 KEEG15 2306 EEG15	7700 6000	35 36.5	57.0 65.5	1.0 1.1	0.282 0.540
2207 EEG15 2207 KEEG15 2307 EEG15	6600 5300	41.5 43	65.5 71.0	1.1 1.5	0.430 0.730
2208 EEG15 2208 KEEG15 2308 EEG15	5900 4800	46.5 48	73.5 82.0	1.1 1.5	0.545 0.990
2209 EEG15 2209 KEEG15 2309 EEG15	5400 4300	51.5 53	78.5 92.0	1.1 1.5	0.579 1.400
2210 EEG15 2210 KEEG15 2310 EEG15	5000 3900	56.5 59	83.5 101.0	1.1 2.0	0.630 1.780
2211 EEG15 2211 KEEG15	6000	63	91.0	1.5	0.790
2212 EEG15	3600	68	101.0	1.5	1.160

* These are the speed limits according to the SNR concept (see pages 85 to 87).



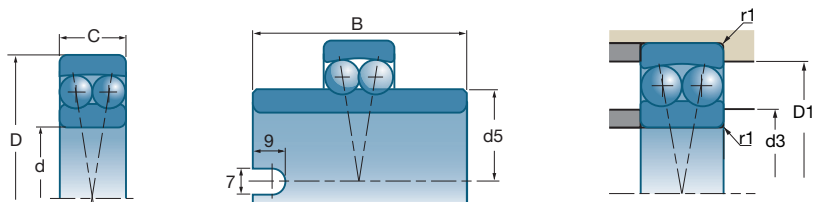

Double-row self-aligning ball bearings (continued)

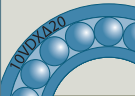

d		D	B	C			e	Y		Yo
								$\frac{F_a}{F_r} \leq e$	$\frac{F_a}{F_r} > e$	
20	References	47	40	14.0	10 ³ N	10 ³ N	0.28	2.2	3.4	2.2
25	11204 G15	52	44	15.0	9.9	2.7	0.28	2.2	3.4	2.2
	11305 G15	62	48	17.0	12.1	3.3	0.28	2.2	3.4	2.2
30	11206 G15	62	48	16.0	15.7	4.7	0.23	2.7	4.2	2.7
	11306 G15	72	52	19.0	21.3	6.3	0.26	2.4	3.8	2.4
35	11207 G15	72	52	17.0	15.8	5.2	0.23	2.7	4.2	2.7
40	11208 G15	80	56	18.0	19.2	6.5	0.21	2.9	4.5	2.9
	11308 G15	90	58	23.0	29.5	9.8	0.26	2.4	3.8	2.4
45	11209 G15	85	58	19.0	21.8	7.4	0.21	2.9	4.5	2.9
	11309	100	60	38.0	38.0	12.9	0.26	2.4	3.8	2.4
50	11210 G15	90	58	20.0	22.7	8.1	0.20	3.2	4.9	3.2
	11310	110	62	43.5	42.5	14.3	0.20	2.8	4.3	2.8
55	11211 G15	100	60	21.0	27.0	10.0	0.20	3.2	4.9	3.2
60	11212 G15	110	62	22.0	30.0	11.6	0.18	3.6	5.5	3.6

■ Double-row self-aligning ball bearings with wide inner ring



			d_5	D1 max	r1 max	
References	rpm*	rpm*	mm	mm	mm	kg
11204 G15	9400	12000	29.2	42	1	0.180
11205 G15 11305 G15	8100 6700	10000 8300	33.3 38.0	47 55	1 1	0.220 0.410
11206 G15 11306 G15	6900 5700	8600 7000	40.1 45.0	57 65	1 1	0.350 0.610
11207 G15	5900	7400	47.7	65	1	0.540
11208 G15 11308 G15	5200 4400	6500 5500	54.0 57.7	73 82	1 1	0.720 1.080
11209 G15 11309	4800 4000	6100 4900	57.7 63.9	78 92	1 1	0.770 1.380
11210 G15 11310	4500 3600	5600 4500	62.7 70.3	83 99	1 1.1	0.850 1.720
11211 G15	4000	5000	70.3	92	1.5	1.130
11212 G15	3600	4500	78.0	102	1.5	1.500

* These are the speed limits according to the SNR concept (see pages 85 to 87).

Cylindrical roller bearings



Cylindrical roller bearings	292
■ Definition and capabilities	292
■ Series	292
■ Variants	293
■ Tolerances and clearances	294
■ Design criteria	296
■ Installation/assembly criteria	297
■ Suffixes	297
■ Characteristics	298

Cylindrical roller bearings

Definition and capabilities

→ Definition

Cylindrical roller bearings offer excellent resistance to instantaneous overloads and shocks.

They simplify assembly thanks to their detachable elements and allow, for certain types, axial displacement or low axial load, for other types.

■ Cages

The standard cage for these bearings is the polyamide cage (suffix GI5) which allows bearing operating temperatures of 120°C or 248°F (150° or 302°F peak).

The standard cage for series 4 is in pressed steel.

The machined brass cage is available on option. Large-dimension bearings are equipped with a machined brass cage (suffix M). For special applications in which the synthetic material cage is unacceptable, a metal cage can be provided on request.

→ Capabilities

■ Loads and speeds

Cylindrical roller bearings are designed to:

- withstand radial loads
- withstand moderate axial loads if the position of the shoulders on the rings allows them
- accept high speeds of rotation

■ Misalignment

Cylindrical roller bearings accept misalignment of about 0.06° thanks to the correction on the roller surface profiles.

Series

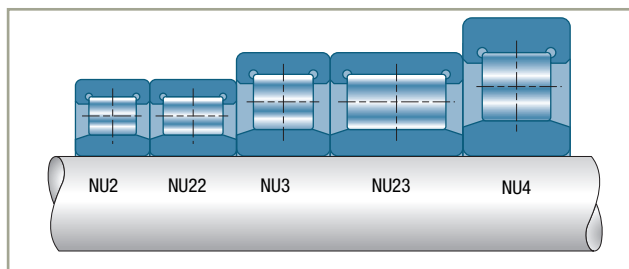

Variants

Types of bearings

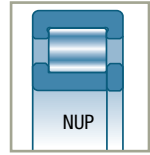
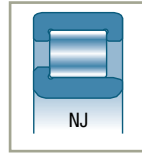
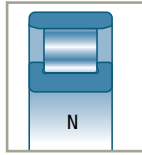
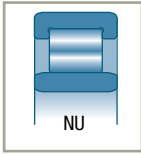

Groove for snap ring

These bearings can be supplied on request with a groove in the outer ring (N) and snap ring (NR) per ISO 464 standard.

The dimensions of the grooves and rings are therefore the same as those defined for the ball bearings of the same dimension series.

Incomplete bearings

Type RN: type N bearing without outer ring.

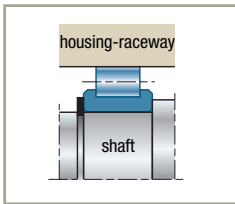

Type RNU: type NU bearing without inner ring.

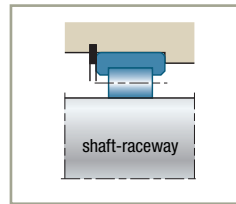

In both cases, the raceway corresponding to the absent ring is integrally machined in the mechanism. The geometry, surface condition and hardness of the part forming the raceway must meet precise specifications. Consult SNR.



Cylindrical roller bearings *(continued)*

Tolerances and clearances

→ Tolerances

These bearings are supplied in standard precision with tolerances in compliance with ISO 492 Standard.

SNR can supply bearings with tightened tolerances on one or several characteristics on request (bore, outer diameter, precision of rotation).

→ Clearances

■ Internal radial clearance

The bearing is supplied matched (in conformity with ISO 5753 Standard), that is to say that the detachable elements

(outer ring and inner ring) are associated so that the clearance is in the "matched" bearing category.

If one of the detachable elements is replaced by the complementary element of another bearing, the clearance enters the "interchangeable" bearing category, with a higher tolerance.

Order of size of recommended residual clearance after fitting:

$$J_{rm} = 4 d^{1/2} 10^{-3}$$

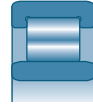

■ Series N..2-N..3-N..4-N..22-N..23

Bore diameter d (mm)	Group 2		Group N		Group 3		Group 4		Group 5	
	min	max	min	max	min	max	min	max	min	max
d ≤ 10	0	25	20	45	35	60	50	75	–	–
10 < d ≤ 24	0	25	20	45	35	60	50	75	65	90
24 < d ≤ 30	0	25	20	45	35	60	50	75	70	95
30 < d ≤ 40	5	30	25	50	45	70	60	85	80	105
40 < d ≤ 50	5	35	30	60	50	80	70	100	95	125
50 < d ≤ 65	10	40	40	70	60	90	80	110	110	140
65 < d ≤ 80	10	45	40	75	65	100	90	125	130	165
80 < d ≤ 100	15	50	50	85	75	110	105	140	155	190
100 < d ≤ 120	15	55	50	90	85	125	125	165	180	220
120 < d ≤ 140	15	60	60	105	100	145	145	190	200	245
140 < d ≤ 160	20	70	70	120	115	165	165	215	225	275
160 < d ≤ 180	25	75	75	125	120	170	170	220	250	300
180 < d ≤ 200	35	90	90	145	140	195	195	250	275	330
200 < d ≤ 225	45	105	105	165	160	220	220	280	305	365
225 < d ≤ 250	45	110	110	175	170	235	235	300	330	395
250 < d ≤ 280	55	125	125	195	190	260	260	330	370	440
280 < d ≤ 315	55	130	130	205	200	275	275	350	410	485
315 < d ≤ 355	65	145	145	225	225	305	305	385	455	535
355 < d ≤ 400	100	190	190	280	280	370	370	460	510	600
400 < d ≤ 450	110	210	210	310	310	410	410	510	565	665
450 < d ≤ 500	110	220	220	330	330	440	440	550	625	735

Value in μm



Cylindrical roller bearings (continued)

■ Axial clearance

The axial clearance of cylindrical roller bearings is only specified for type NUP bearings. It is limited by the 4 internal shoulders. It is in the range of 0.1 mm.

Bearings of types N, NU or NJ allow axial displacement between the inner ring and the outer ring. It is defined by the difference between the working length (W) of the ring raceways and the effective length of the rollers.

For types N or NU, it is in the range of 2 mm for bearings with bore diameters below 80 mm in series 2, and below 50 mm in series 3. For the largest bearings it is of the order of 3 mm. For all type NJ bearings the possible axial displacement is half the values indicated above.

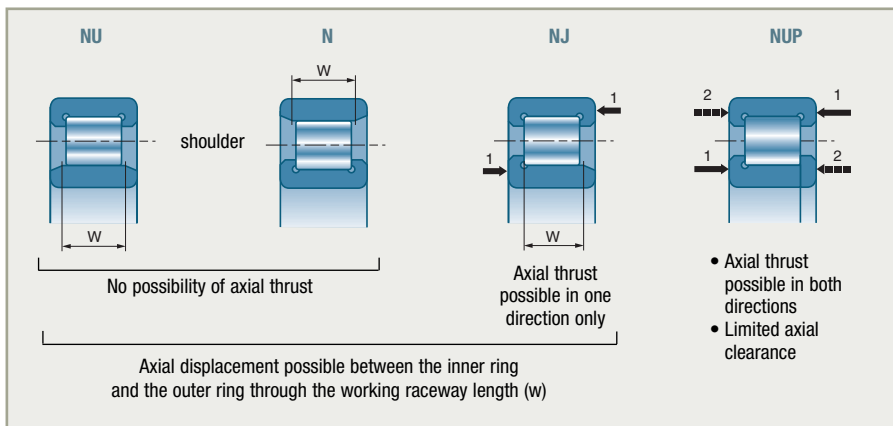

Design criteria

■ Bearing life

Cylindrical roller bearings are only designed to withstand radial loads F_r .

However, these bearings can accept an axial load F_a if their inner and outer rings are shouldered.

If the ratio F_a/F_r is less than 0.1, only the radial load is taken into consideration.

If the ratio F_a/F_r is greater than 0.1, the friction energy generated on the shoulders by the axial load and the wear that can result from this may be so high that bearing performance is drastically modified.

Consult SNR to evaluate the ratio according to the operating conditions (speed, lubrication, etc.).

■ Maximum static radial capacity

This is given by the basic static capacity C_0 .

Installation/assembly criteria

As the rings of cylindrical roller bearings are separable, they are totally interchangeable within the clearance tolerance limits.

They can also be interchanged with bearings of the same reference from other manufacturers. The dimension above the rollers (D_5) or below the rollers (d_5) and the tolerances are indicated in the "Tables of Product Characteristics" in conformity with DIN 5412 Standard.

However, since the raceway profile corrections, quality of steel and surface conditions are specific to each manufacturer, the performance of such assemblies may be significantly changed in a replacement, therefore they should be avoided.

Caution: dimensions D_5 and d_5 of the new generation of cylindrical roller bearings (suffix E) differ from those of the previous generation.

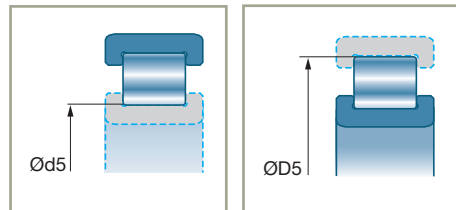

Suffixes

E	Optimised capacity bearing
G15	Polyamide cage
J	Clearance. The first figure designates the ISO clearance category, the second designates the normal precision class (0). Equivalence: J20 = C2, J30 = C3, J40 = C4, J50 = C5
M	Machined brass cage centred on the rollers
N	Outer ring with groove for snap ring
NR	Outer ring with groove and snap ring fitted

Cylindrical roller bearings (continued)

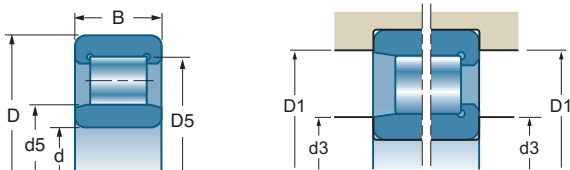



d		D	B	D5 (Ø above the rollers)	d5 (Ø below the rollers)			
mm	References	mm	mm	mm	mm	10°N	10°N	
15	NJ 202 EG15	35	11	—	19,3	15,1	10,4	
	NU 202 EG15	35	11	—	19,3	15,1	10,4	
17	NJ 203 EG15	40	12	—	22,1	20,8	14,6	
	NU 203 EG15	40	12	—	22,1	17,6	14,6	
	NJ 2203 EG15	40	16	—	22,1	28,5	21,9	
	NU 2203 EG15	40	16	—	22,1	24	22	
	NJ 303 EG15	47	14	—	24,2	30	21,2	
	NU 303 EG15	47	14	—	24,2	25,5	21,2	
20	N 204 EG15	47	14	41,5	—	32,5	24,7	
	NJ 204 EG15	47	14	—	26,5	27,5	24,5	
	NU 204 EG15	47	14	—	26,5	27,5	24,5	
	NUP 204 EG15	47	14	—	26,5	27,5	24,5	
	NJ 2204 EG15	47	18	—	26,5	32,5	31	
	NU 2204 EG15	47	18	—	26,5	32,5	31	
	N 304 EG15	52	15	45,5	—	36,5	26	
	NJ 304 EG15	52	15	—	27,5	31,5	27	
	NU 304 EG15	52	15	—	27,5	31,5	27	
	NJ 2304 EG15	52	21	—	27,5	41,5	39	
	NU 2304 EG15	52	21	—	27,5	41,5	39	
	25	N 205 EG15	52	15	46,5	—	34,5	27,5
NJ205E		52	15	—	31,5	29,3	27,7	
NJ 205 EG15		52	15	—	31,5	29	27,5	
NU 205 EG15		52	15	—	31,5	29	27,5	
NUP 205 EG15		52	15	—	31,5	29	27,5	
NJ 2205 EG15		52	18	—	31,5	34,5	34,5	
NU 2205 EG15		52	18	—	31,5	34,5	34,5	
NUP 2205 EG15		52	18	—	31,5	34,5	34,5	
N 305 EG15		62	17	54	—	48	36,5	
NJ 305 EG15		62	17	—	34	41,5	37,5	
NU 305 EG15		62	17	—	34	41,5	37,5	
NUP 305 EG15		62	17	—	34	41,5	37,5	
NJ2305E		62	24	—	34	56,9	56,1	
NJ 2305 EG15		62	24	—	34	57	56	
NU 2305 EG15		62	24	—	34	57	56	
30		N 206 EG15	62	16	55,5	—	45	36
		NJ206E	62	16	—	37,5	39,1	37,4
		NJ 206 EG15	62	16	—	37,5	39	37,5
	NU206E	62	16	—	37,5	39,1	37,4	
	NJ 206 EG15	62	16	—	37,5	39	37,5	
	NUP 206 EG15	62	16	—	37,5	39	37,5	
	NJ 2206 EG15	62	20	—	37,5	49	50	
	NU 2206 EG15	62	20	—	37,5	49	50	
	NJ 2206 EG15	62	20	—	37,5	49	50	
	NUP 2206 EG15	62	20	—	37,5	49	50	

Characteristics

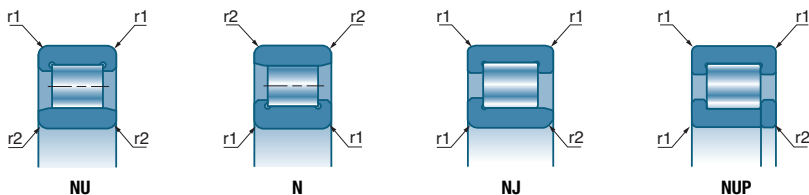
■ Single-row cylindrical roller bearings







References			d3 max mm	D1 min mm	r1 max mm	r2 max mm	
	rpm*	rpm*					
NJ 202 EG15 NU 202 EG15	17000 17000	21000 21000	17,4 17,4	30,8 30,8	0,6 0,6	0,3 0,3	0,049 0,050
NJ 203 EG15 NU 203 EG15 NJ 2203 EG15 NU 2203 EG15 NJ 303 EG15 NU 303 EG15	15000 15000 15000 15000 13000 13000	18000 18000 18000 18000 15000 15000	19,4 19,4 19,4 19,4 21,2 21,2	35,8 35,8 35,8 35,8 41,4 41,4	0,6 0,6 0,6 0,6 1 1	0,3 0,3 0,3 0,3 0,6 0,6	0,070 0,069 0,053 0,051 0,125 0,122
N 204 EG15 NJ 204 EG15 NU 204 EG15 NUP 204 EG15 NJ 2204 EG15 NU 2204 EG15 N 304 EG15 NJ 304 EG15 NU 304 EG15 NJ 2304 EG15 NU 2304 EG15	12000 12000 12000 12000 12000 12000 11000 11000 11000 10000 10000	15000 15000 15000 15000 15000 15000 13000 13000 13000 13000 13000	24,2 24,2 24,2 24,2 24,2 24,2 24,2 24,2 24,2 24,2 24,2	41,4 41,4 41,4 41,4 41,4 41,4 46,4 46,4 46,4 46,4 46,4	1 1 1 1 1 1 1,1 1,1 1,1 1,1 1,1	0,6 0,6 0,6 0,6 0,6 0,6 0,6 0,6 0,6 0,6 0,6	0,110 0,117 0,114 0,119 0,150 0,146 0,151 0,156 0,140 0,220 0,215
N 205 EG15 NJ205E NJ 205 EG15 NU 205 EG15 NUP 205 EG15 NJ 2205 EG15 NU 2205 EG15 NUP 2205 EG15 N 305 EG15 NJ 305 EG15 NU 305 EG15 NUP 305 EG15 NJ2305E NJ 2305 EG15 NU 2305 EG15	11000 12600 11000 11000 11000 11000 11000 11000 9500 9500 9500 9500 11000 9000 9000	13000 15000 13000 13000 13000 13000 13000 13000 11000 11000 11000 11000 13000 11000 11000	29,2 29,2 29,2 29,2 29,2 29,2 29,2 29,2 32 32 32 32 32 32 32	46,4 46,4 46,4 46,4 46,4 46,4 46,4 46,4 55 55 55 55 55 55 55	1 1 1 1 1 1 1 1 1,1 1,1 1,1 1,1 1,1 1,1 1,1	0,6 0,6 0,6 0,6 0,6 0,6 0,6 0,6 1,1 1,1 1,1 1,1 1,1 1,1 1,1	0,135 0,147 0,140 0,137 0,145 0,164 0,164 0,174 0,242 0,250 0,245 0,256 0,367 0,347 0,349
N 206 EG15 NJ206E NJ 206 EG15 NU206E NU 206 EG15 NUP 206 EG15 NJ 2206 EG15 NU 2206 EG15 NUP 2206 EG15	9400 10600 9400 10600 9400 9400 9400 9400 9400	11000 12600 11000 12600 11000 11000 11000 11000 11000	34,2 34,2 34,2 34,2 34,2 34,2 34,2 34,2 34,2	56,4 56,4 56,4 56,4 56,4 56,4 56,4 56,4 56,4	1 1 1 1 1 1 1 1 1	0,6 0,6 0,6 0,6 0,6 0,6 0,6 0,6 0,6	0,210 0,221 0,213 0,216 0,213 0,220 0,261 0,255 0,268

* These are the speed limits according to the SNR concept (see pages 85 to 87).

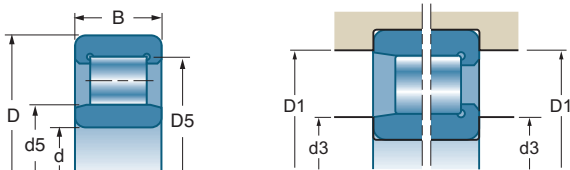





Cylindrical roller bearings (continued)

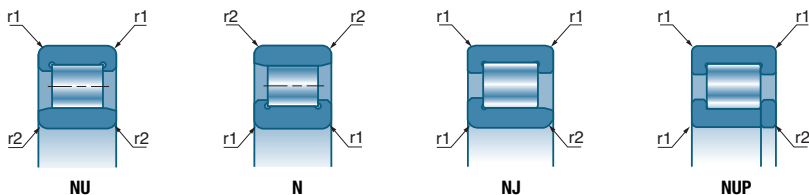

d		D	B	D5 (Ø above the rollers)	d5 (Ø below the rollers)		
						10°N	10°N
mm	References	mm	mm	mm	mm		
30	N 306 EG15	72	19	62,5	–	61	48
	NJ 306E	72	19	–	40,5	50,9	47,5
	NJ 306 EG15	72	19	–	40,5	51	48
	NU306E	72	19	–	40,5	50,9	47,5
	NU 306 EG15	72	19	–	40,5	51	48
	NUP 306 EG15	72	19	–	40,5	51	48
	NJ2306E	72	27	–	40,5	72,5	74,9
	NJ 2306 EG15	72	27	–	40,5	73,5	75
	NU 2306 EG15	72	27	–	40,5	73,5	75
35	N 207 EG15	72	17	64	–	58	48,5
	NJ207E	72	17	–	44	50,3	50,2
	NJ 207 EG15	72	17	–	44	50	50
	NU207E	72	17	–	44	50,3	50,2
	NU 207 EG15	72	17	–	44	50	50
	NUP207E	72	17	–	44	50,3	50,2
	NUP 207 EG15	72	17	–	44	50	50
	NJ 2207 EG15	72	23	–	44	62	65,5
	NU2207E	72	23	–	44	61,6	65,3
	NU 2207 EG15	72	23	–	44	62	65,5
	NUP 2207 EG15	72	23	–	44	62	65,5
	N 307 EG15	80	21	70,2	–	76	63
	NJ 307 EG15	80	21	–	46,2	64	63
	NU 307 EG15	80	21	–	46,2	64	63
	NUP 307 EG15	80	21	–	46,2	64	63
	NJ 2307 EG15	80	31	–	46,2	91,5	98
	NU 2307 EG15	80	31	–	46,2	91,5	98
	NJ 407	100	25	–	53	79	71
	NU 407	100	25	–	53	79	71
	40	N 208 EG15	80	18	71,5	–	53
NJ208E		80	18	–	49,5	53,1	52,1
NJ 208 EG15		80	18	–	49,5	53	53
NU208E		80	18	–	49,5	53,1	52,1
NU 208 EG15		80	18	–	49,5	53	53
NUP208E		80	18	–	49,5	53,1	52,1
NUP 208 EG15		80	18	–	49,5	53	53
NJ2208E		80	23	–	49,5	69,9	74,3
NJ 2208 EG15		80	23	–	49,5	71	75
NU2208E		80	23	–	49,5	69,9	74,3
NU 2208 EG15		80	23	–	49,5	71	75
NUP 2208 EG15		80	23	–	49,5	71	75
N 308 EG15		90	23	80	–	95	78
NJ308E		90	23	–	52	80,4	78
NJ 308 EG15		90	23	–	52	81,5	78
NU308E		90	23	–	52	80,4	78
NU 308 EG15		90	23	–	52	81,5	78

■ Single-row cylindrical roller bearings (continued)



References	  		d3 max	D1 min	r1 max	r2 max	
	rpm*	rpm*	mm	mm	mm	mm	
N 306 EG15	8100	9700	37	65	1,1	1,1	0,366
NJ306E	8400	10000	37	65	1,1	1,1	0,375
NJ 306 EG15	8100	9700	37	65	1,1	1,1	0,376
NU306E	8400	10000	37	65	1,1	1,1	0,375
NU 306 EG15	8100	9700	37	65	1,1	1,1	0,368
NUP 306 EG15	8100	9700	37	65	1,1	1,1	0,385
NJ2306E	9500	11500	37	65	1,1	1,1	0,558
NJ 2306 EG15	7700	9700	37	65	1,1	1,1	0,540
NU 2306 EG15	7700	9700	37	65	1,1	1,1	0,529
N 207 EG15	8100	9800	39,2	65	1,1	0,6	0,300
NJ207E	8900	10600	39,2	65	1,1	0,6	0,319
NJ 207 EG15	8100	9800	39,2	65	1,1	0,6	0,309
NU207E	8900	10600	39,2	65	1,1	0,6	0,312
NU 207 EG15	8100	9800	39,2	65	1,1	0,6	0,303
NUP207E	8900	10600	39,2	65	1,1	0,6	0,337
NUP 207 EG15	8100	9800	39,2	65	1,1	0,6	0,317
NJ 2207 EG15	8100	9800	39,2	65	1,1	0,6	0,416
NU2207E	8900	10600	39,2	65	1,1	0,6	0,410
NU 2207 EG15	8100	9800	39,2	65	1,1	0,6	0,406
NUP 2207 EG15	8100	9800	39,2	65	1,1	0,6	0,427
N 307 EG15	7200	8500	42	71	1,5	1,1	0,486
NJ 307 EG15	7200	8500	42	71	1,5	1,1	0,496
NU 307 EG15	7200	8500	42	71	1,5	1,1	0,485
NUP 307 EG15	7200	8500	42	71	1,5	1,1	0,506
NJ 2307 EG15	6800	8500	42	71	1,5	1,1	0,736
NU 2307 EG15	6800	8500	42	71	1,5	1,1	0,723
NJ 407	6300	7600	46	89	1,5	1,5	1,030
NU 407	6300	7600	46	89	1,5	1,5	1,030
N 208 EG15	7200	8700	47	73	1,1	1,1	0,360
NJ208E	7900	9400	47	73	1,1	1,1	0,402
NJ 208 EG15	7200	8700	47	73	1,1	1,1	0,389
NU208E	7900	9400	47	73	1,1	1,1	0,394
NU 208 EG15	7200	8700	47	73	1,1	1,1	0,379
NUP208E	7900	9400	47	73	1,1	1,1	0,388
NUP 208 EG15	7200	8700	47	73	1,1	1,1	0,399
NJ2208E	7500	8900	47	73	1,1	1,1	0,515
NJ 2208 EG15	7200	8700	47	73	1,1	1,1	0,504
NU2208E	7500	8900	47	73	1,1	1,1	0,504
NU 2208 EG15	7200	8700	47	73	1,1	1,1	0,492
NUP 2208 EG15	7200	8700	47	73	1,1	1,1	0,518
N 308 EG15	6300	7500	49	81	1,5	1,5	0,660
NJ308E	6700	7900	49	81	1,5	1,5	0,690
NJ 308 EG15	6300	7500	49	81	1,5	1,5	0,674
NU308E	6700	7900	49	81	1,5	1,5	0,690
NU 308 EG15	6300	7500	49	81	1,5	1,5	0,659

* These are the speed limits according to the SNR concept (see pages 85 to 87).



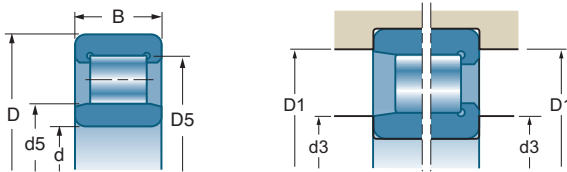

Cylindrical roller bearings (continued)

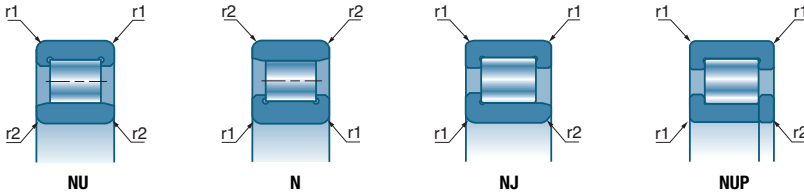

d		D	B	D5 (Ø above the rollers)	d5 (Ø below the rollers)		
mm	References	mm	mm	mm	mm	10 ³ N	10 ³ N
40	NUP 308 EG15	90	23	—	52	81,5	78
	NJ 2308 EG15	90	33	—	52	112	120
	NU 2308 EG15	90	33	—	52	112	120
	NJ 408	110	27	—	58	93	86,5
	NU 408	110	27	—	58	93	86,5
45	N 209 EG15	85	19	76,5	—	61	63
	NJ209E	85	19	—	54,5	60,4	62,8
	NJ 209 EG15	85	19	—	54,5	61	63
	NU209E	85	19	—	54,5	60,4	62,8
	NU 209 EG15	85	19	—	54,5	61	63
	NUP209E	85	19	—	54,5	60,4	62,8
	NUP 209 EG15	85	19	—	54,5	61	63
	NJ 2209 EG15	85	23	—	54,5	73,5	81,5
	NU2209E	85	23	—	54,5	73,5	80,9
	NU 2209 EG15	85	23	—	54,5	73,5	81,5
	NUP 2209 EG15	85	23	—	54,5	73,5	81,5
	N 309 EG15	100	25	88,5	—	115	98
	NJ309E	100	25	—	58,5	97,4	98,3
	NJ 309 EG15	100	25	—	58,5	98	100
	NU309E	100	25	—	58,5	97,4	98,3
	NU 309 EG15	100	25	—	58,5	98	100
	NUP 309 EG15	100	25	—	58,5	98	100
	NJ 2309 EG15	100	36	—	58,5	137	153
	NU2309E	100	36	—	58,5	137,3	153
	NU 2309 EG15	100	36	—	58,5	137	153
	NJ 409	120	29	—	64,5	106	100
	NU 409	120	29	—	64,5	106	100
	50	N 210 EG15	90	20	81,5	—	64
NJ210E		90	20	—	59,5	63,2	68
NJ 210 EG15		90	20	—	59,5	64	68
NU210E		90	20	—	59,5	63,2	68
NU 210 EG15		90	20	—	59,5	64	68
NUP210E		90	20	—	59,5	63,2	68
NUP 210 EG15		90	20	—	59,5	64	68
NJ 2210 EG15		90	23	—	59,5	78	88
NU2210E		90	23	—	59,5	76,9	87,6
NU 2210 EG15		90	23	—	59,5	78	88
NUP 2210 EG15		90	23	—	59,5	78	88
N 310 EG15		110	27	97	—	130	113
NJ 310 EG15		110	27	—	65	110	114
NU 310 EG15		110	27	—	65	110	114
NUP 310 EG15		110	27	—	65	110	114
NJ 2310 EG15		110	40	—	65	163	186
NU 2310 EG15		110	40	—	65	163	186
NJ 410		130	31	—	70,8	136	128
NU 410		130	31	—	70,8	129	125

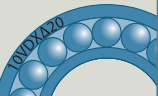
■ Single-row cylindrical roller bearings (continued)



References	  		d3 max	D1 min	r1 max	r2 max	
	rpm*	rpm*	mm	mm	mm	mm	
NUP 308 EG15	6300	7500	49	81	1,5	1,5	0,688
NJ 2308 EG15	6000	7500	49	81	1,5	1,5	0,978
NU 2308 EG15	6000	7500	49	81	1,5	1,5	0,958
NJ 408	5700	6900	53	97	2	2	1,310
NU 408	5700	6900	53	97	2	2	1,300
N 209 EG15	6700	8000	52	78	1,1	1,1	0,430
NJ209E	7500	8900	52	78	1,1	1,1	0,455
NJ 209 EG15	6700	8000	52	78	1,1	1,1	0,445
NU209E	7500	8900	52	78	1,1	1,1	0,444
NU 209 EG15	6700	8000	52	78	1,1	1,1	0,445
NUP209E	7500	8900	52	78	1,1	1,1	0,478
NUP 209 EG15	6700	8000	52	78	1,1	1,1	0,457
NJ 2209 EG15	6700	8000	52	78	1,1	1,1	0,530
NU2209E	7100	8400	52	78	1,1	1,1	0,543
NU 2209 EG15	6700	8000	52	78	1,1	1,1	0,532
NUP 2209 EG15	6700	8000	52	78	1,1	1,1	0,559
N 309 EG15	5700	6800	54	91	1,5	1,5	0,895
NJ309E	6000	7100	54	91	1,5	1,5	0,936
NJ 309 EG15	5700	6800	54	91	1,5	1,5	0,913
NU309E	6000	7100	54	91	1,5	1,5	0,915
NU 309 EG15	5700	6800	54	91	1,5	1,5	0,893
NUP 309 EG15	5700	6800	54	91	1,5	1,5	0,934
NJ 2309 EG15	5400	6800	54	91	1,5	1,5	1,330
NU2309E	5600	6700	54	91	1,5	1,5	1,330
NU 2309 EG15	5400	6800	54	91	1,5	1,5	1,290
NJ 409	5200	6300	58	107	2	2	1,650
NU 409	5200	6300	58	107	2	2	1,650
N 210 EG15	6200	7500	57	83	1,1	1,1	0,490
NJ210E	6700	7900	57	83	1,1	1,1	0,510
NJ 210 EG15	6200	7500	57	83	1,1	1,1	0,503
NU210E	6700	7900	57	83	1,1	1,1	0,503
NU 210 EG15	6200	7500	57	83	1,1	1,1	0,490
NUP210E	6700	7900	57	83	1,1	1,1	0,532
NUP 210 EG15	6200	7500	57	83	1,1	1,1	0,517
NJ 2210 EG15	6200	7500	57	83	1,1	1,1	0,586
NU2210E	6300	7500	57	83	1,1	1,1	0,581
NU 2210 EG15	6200	7500	57	83	1,1	1,1	0,575
NUP 2210 EG15	6200	7500	57	83	1,1	1,1	0,600
N 310 EG15	5100	6100	61	99	2	2	1,160
NJ 310 EG15	5100	6100	61	99	2	2	1,190
NU 310 EG15	5100	6100	61	99	2	2	1,160
NUP 310 EG15	5100	6100	61	99	2	2	1,210
NJ 2310 EG15	4900	6100	61	99	2	2	1,770
NU 2310 EG15	4900	6100	61	99	2	2	1,750
NJ 410	4700	5700	64	116	2,1	2,1	2,080
NU 410	4700	5700	64	116	2,1	2,1	2,000

* These are the speed limits according to the SNR concept (see pages 85 to 87).





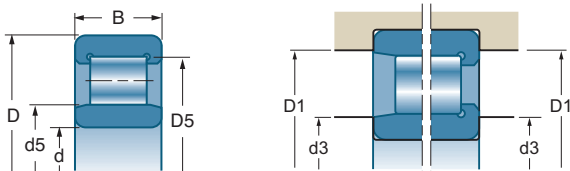

Cylindrical roller bearings (continued)

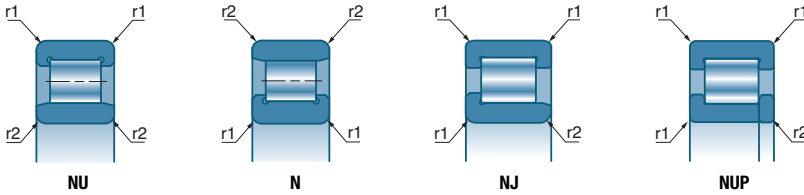

d		D	B	D5 (Ø above the rollers)	d5 (Ø below the rollers)			
						C	C ₀	
mm	References	mm	mm	mm	mm	10 ⁶ N	10 ⁶ N	
55	N 211 EG15	100	21	90	–	83	95	
	NJ 211E	100	21	–	66	83,1	94,2	
	NJ 211 EG15	100	21	–	66	83	95	
	NU 211E	100	21	–	66	83,1	94,2	
	NU 211 EG15	100	21	–	66	83	95	
	NUP 211E	100	21	–	66	83,1	94,2	
	NUP 211 EG15	100	21	–	66	83	95	
	NJ 2211 EG15	100	25	–	66	98	118	
	NU 2211 EG15	100	25	–	66	98	118	
	NUP 2211 EG15	100	25	–	66	98	118	
	N 311 EG15	120	29	106,5	–	159	139	
	NJ 311 EG15	120	29	–	70,5	134	140	
	NU 311 EG15	120	29	–	70,5	134	140	
	NUP 311 EG15	120	29	–	70,5	134	140	
	NJ 2311 EG15	120	43	–	70,5	200	228	
	NU 2311 EG15	120	43	–	70,5	200	228	
60	N 212 EG15	110	22	100	–	95	104	
	NJ 212 EG15	110	22	–	72	95	104	
	NU 212 EG15	110	22	–	72	95	104	
	NUP 212 EG15	110	22	–	72	95	104	
	NJ 2212 EG15	110	28	–	72	129	153	
	NU 2212 EG15	110	28	–	72	129	153	
	NUP 2212 EG15	110	28	–	72	129	153	
	N 312 EG15	130	31	115	–	177	157	
	NJ 312 EG15	130	31	–	77	150	156	
	NU 312 EG15	130	31	–	77	150	156	
	NUP 312 EG15	130	31	–	77	150	156	
	NJ 2312 EG15	130	46	–	77	224	260	
	NU 2312 EG15	130	46	–	77	224	260	
	NU 412	150	35	–	83	181	187	
	65	N 213 EG15	120	23	108,5	–	127	119
		NJ 213 EG15	120	23	–	78,5	108	120
NU 213 EG15		120	23	–	78,5	108	120	
NUP 213 EG15		120	23	–	78,5	108	120	
NJ 2213 EG15		120	31	–	78,5	150	183	
NU 2213 EG15		120	31	–	78,5	150	183	
N 313 EG15		140	33	124,5	–	214	191	
NJ 313 EG15		140	33	–	82,5	180	190	
NU 313 EG15		140	33	–	82,5	180	190	
NJ 2313 EG15		140	48	–	82,5	245	285	
NU 2313 EG15		140	48	–	82,5	245	285	
70		N 214 EG15	125	24	113,5	–	140	137
		NJ 214 EG15	125	24	–	83,5	120	137

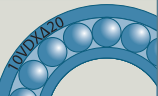
■ Single-row cylindrical roller bearings (continued)



References	  		d3 max	D1 min	r1 max	r2 max	 kg
	rpm*	rpm*	mm	mm	mm	mm	
N 211 EG15	5600	6700	62	91	1,5	1,1	0,670
NJ211E	6300	7500	62	91	1,5	1,1	0,688
NJ 211 EG15	5600	6700	62	91	1,5	1,1	0,679
NU211E	6300	7500	62	91	1,5	1,1	0,674
NU 211 EG15	5600	6700	62	91	1,5	1,1	0,665
NUP211E	6300	7500	62	91	1,5	1,1	0,702
NUP 211 EG15	5600	6700	62	91	1,5	1,1	0,693
NJ 2211 EG15	5600	6700	62	91	1,5	1,1	0,780
NU 2211 EG15	5600	6700	62	91	1,5	1,1	0,800
NUP 2211 EG15	5600	6700	62	91	1,5	1,1	0,828
N 311 EG15	4700	5600	66	109	2	2	1,410
NJ 311 EG15	4700	5600	66	109	2	2	1,510
NU 311 EG15	4700	5600	66	109	2	2	1,480
NUP 311 EG15	4700	5600	66	109	2	2	1,540
NJ 2311 EG15	4500	5600	66	109	2	2	2,270
NU 2311 EG15	4500	5600	66	109	2	2	2,230
N 212 EG15	5100	6100	69	101	1,5	1,5	0,830
NJ 212 EG15	5100	6100	69	101	1,5	1,5	0,845
NU 212 EG15	5100	6100	69	101	1,5	1,5	0,824
NUP 212 EG15	5100	6100	69	101	1,5	1,5	0,909
NJ 2212 EG15	5100	6100	69	101	1,5	1,5	1,100
NU 2212 EG15	5100	6100	69	101	1,5	1,5	1,080
NUP 2212 EG15	5100	6100	69	101	1,5	1,5	1,120
N 312 EG15	4300	5200	72	118	2,1	2,1	1,850
NJ 312 EG15	4300	5200	72	118	2,1	2,1	1,890
NU 312 EG15	4300	5200	72	118	2,1	2,1	1,850
NUP 312 EG15	4300	5200	72	118	2,1	2,1	1,930
NJ 2312 EG15	4100	5200	72	118	2,1	2,1	2,830
NU 2312 EG15	4100	5200	72	118	2,1	2,1	2,780
NU 412	4000	4900	74	136	2,1	2,1	3,000
N 213 EG15	4700	5600	74	111	1,5	1,5	1,050
NJ 213 EG15	4700	5600	74	111	1,5	1,5	1,050
NU 213 EG15	4700	5600	74	111	1,5	1,5	1,040
NUP 213 EG15	4700	5600	74	111	1,5	1,5	1,090
NJ 2213 EG15	4700	5600	74	111	1,5	1,5	1,460
NU 2213 EG15	4700	5600	74	111	1,5	1,5	1,430
N 313 EG15	4000	4800	77	128	2,1	2,1	2,240
NJ 313 EG15	4000	4800	77	128	2,1	2,1	2,320
NU 313 EG15	4000	4800	77	128	2,1	2,1	2,280
NJ 2313 EG15	3800	4800	77	128	2,1	2,1	3,380
NU 2313 EG15	3800	4800	77	128	2,1	2,1	3,320
N 214 EG15	4400	5300	79	116	1,5	1,5	1,159
NJ 214 EG15	4400	5300	79	116	1,5	1,5	1,180

* These are the speed limits according to the SNR concept (see pages 85 to 87).





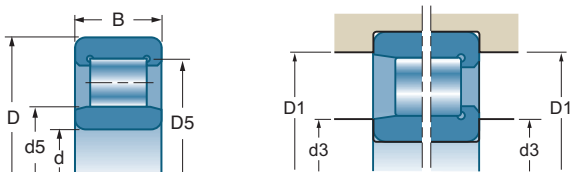

Cylindrical roller bearings (continued)

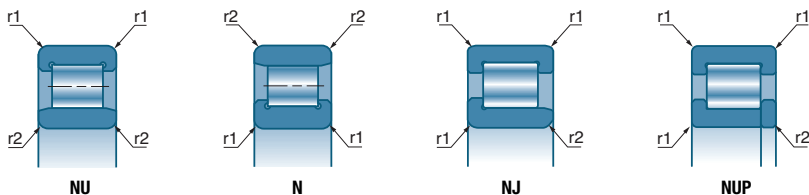

d		D	B	D5 (Ø above the rollers)	d5 (Ø below the rollers)			
						10°N	C ₀	
mm	References	mm	mm	mm	mm	10°N	10°N	
70	NU 214 EG15	125	24	—	83,5	120	137	
	NUP 214 EG15	125	24	—	83,5	120	137	
	NJ 2214 EG15	125	31	—	83,5	156	196	
	NU 2214 EG15	125	31	—	83,5	156	196	
	N 314 EG15	150	35	133	—	242	222	
	NJ 314 EG15	150	35	—	89	204	220	
	NU 314 EG15	150	35	—	89	204	220	
	NJ 2314 EG15	150	51	—	89	275	325	
	NU 2314 EG15	150	51	—	89	275	325	
	NJ 414M	180	42	—	100	246	260	
	75	N 215 EG15	130	25	118,5	—	132	156
NJ 215 EG15		130	25	—	88,5	132	156	
NU215E		130	25	—	88,5	130	156,4	
NU 215 EG15		130	25	—	88,5	132	156	
NUP 215 EG15		130	25	—	88,5	132	156	
NJ 2215 EG15		130	31	—	88,5	163	208	
NU 2215 EG15		130	31	—	88,5	163	208	
N 315 EG15		160	37	143	—	285	265	
NJ 315 EG15		160	37	—	95	240	265	
NU 315 EG15		160	37	—	95	240	265	
NJ 2315 EG15		160	55	—	95	325	390	
NU 2315 EG15		160	55	—	95	325	390	
80		N 216 EG15	140	26	127,3	—	165	167
	NJ 216 EG15	140	26	—	95,3	140	170	
	NU 216 EG15	140	26	—	95,3	140	170	
	NJ 2216 EG15	140	33	—	95,3	186	245	
	NU 2216 EG15	140	33	—	95,3	186	245	
	N 316 EG15	170	39	151	—	300	275	
	NJ 316 EG15	170	39	—	101	300	275	
	NU 316 EG15	170	39	—	101	255	275	
	NUP 316 EG15	170	39	—	101	255	275	
	NU 2316 EG15	170	58	—	101	420	425	
	85	N 217 EG15	150	28	136,5	—	194	194
		NJ 217 EG15	150	28	—	100,5	163	193
NU 217 EG15		150	28	—	100,5	163	193	
NJ 2217 EG15		150	36	—	100,5	216	275	
NU 2217 EG15		150	36	—	100,5	216	275	
N 317 EM		180	41	160	—	340	325	
NJ 317 EG15		180	41	—	108	320	300	
NU 317 EG15		180	41	—	108	270	300	
NUP 317 EG15		180	41	—	108	270	300	
NU 2317 EG15		180	60	—	108	435	445	

■ Single-row cylindrical roller bearings (continued)







References	  		d3 max	D1 min	r1 max	r2 max	kg
	rpm*	rpm*	mm	mm	mm	mm	
NU 214 EG15	4400	5300	79	116	1,5	1,5	1,150
NUP 214 EG15	4400	5300	79	116	1,5	1,5	1,200
NJ 2214 EG15	4400	5300	79	116	1,5	1,5	1,520
NU 2214 EG15	4400	5300	79	116	1,5	1,5	1,520
N 314 EG15	3700	4500	82	138	2,1	2,1	2,800
NJ 314 EG15	3700	4500	82	138	2,1	2,1	2,840
NU 314 EG15	3700	4500	82	138	2,1	2,1	2,790
NJ 2314 EG15	3600	4500	82	138	2,1	2,1	4,090
NU 2314 EG15	3600	4500	82	138	2,1	2,1	4,020
NJ 414M	3400	4100	86	164	3	3	6,070
<hr/>							
N 215 EG15	4200	5100	84	121	1,5	1,5	1,290
NJ 215 EG15	4200	5100	84	121	1,5	1,5	1,300
NU215E	4500	5300	84	121	1,5	1,5	1,300
NU 215 EG15	4200	5100	84	121	1,5	1,5	1,270
NUP 215 EG15	4200	5100	84	121	1,5	1,5	1,330
NJ 2215 EG15	4200	5100	84	121	1,5	1,5	1,640
NU 2215 EG15	4200	5100	84	121	1,5	1,5	1,610
N 315 EG15	3500	4200	87	148	2,1	2,1	3,300
NJ 315 EG15	3500	4200	87	148	2,1	2,1	3,390
NU 315 EG15	3500	4200	87	148	2,1	2,1	3,330
NJ 2315 EG15	3300	4200	87	148	2,1	2,1	5,040
NU 2315 EG15	3300	4200	87	148	2,1	2,1	4,950
<hr/>							
N 216 EG15	3900	4700	91	129	2	2	1,540
NJ 216 EG15	3900	4700	91	129	2	2	1,580
NU 216 EG15	3900	4700	91	129	2	2	1,540
NJ 2216 EG15	3900	4700	91	129	2	2	2,050
NU 2216 EG15	3900	4700	91	129	2	2	2,020
N 316 EG15	3300	3900	92	158	2,1	2,1	3,930
NJ 316 EG15	3300	3900	92	158	2,1	2,1	4,040
NU 316 EG15	3300	3900	92	158	2,1	2,1	3,960
NUP 316 EG15	3300	3900	92	158	2,1	2,1	4,110
NU 2316 EG15	3100	3900	92	158	2,1	2,1	5,900
<hr/>							
N 217 EG15	3700	4400	96	139	2	2	1,890
NJ 217 EG15	3700	4400	96	139	2	2	1,950
NU 217 EG15	3700	4400	96	139	2	2	1,910
NJ 2217 EG15	3700	4400	96	139	2	2	2,550
NU 2217 EG15	3700	4400	96	139	2	2	2,500
N 317 EM	3100	3700	99	166	3	3	5,330
NJ 317 EG15	3100	3700	99	166	3	3	4,712
NU 317 EG15	3100	3700	99	166	3	3	4,620
NUP 317 EG15	3100	3700	99	166	3	3	5,200
NU 2317 EG15	2900	3700	99	166	3	3	6,710

* These are the speed limits according to the SNR concept (see pages 85 to 87).

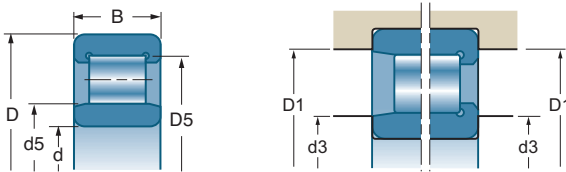



Cylindrical roller bearings (continued)

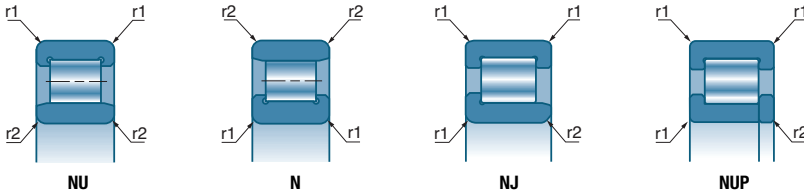

d mm		D mm	B mm	D5 (Ø above the rollers) mm	d5 (Ø below the rollers) mm			
						10 ⁶ N	10 ⁶ N	
90	N 218 EG15	160	30	145	–	215	217	
	NJ 218 EG15	160	30	–	107	183	216	
	NU 218 EG15	160	30	–	107	183	216	
	NJ 2218 EG15	160	40	–	107	240	315	
	NU 2218 EG15	160	40	–	107	240	315	
	N 318 EM	190	43	169,5	–	370	350	
	NJ 318 EG15	190	43	–	113,5	370	350	
	NU 318 EG15	190	43	–	113,5	315	345	
	NJ 2318 EM	190	64	–	113,5	510	530	
	NU 2318 EG15	190	64	–	113,5	510	530	
	95	N 219 EG15	170	32	154,5	–	260	265
NJ 219 EG15		170	32	–	112,5	260	265	
NU 219 EG15		170	32	–	112,5	260	265	
NJ 2219 EG15		170	43	–	112,5	340	370	
NU 2219 EG15		170	43	–	112,5	340	370	
N 319 EM		200	45	177,5	–	390	380	
NJ 319 EG15		200	45	–	121,5	390	380	
NU 319 EG15		200	45	–	121,5	390	380	
NU 2319 EG15		200	67	–	121,5	540	580	
100		N 220 EG15	180	34	163	–	295	305
		NJ 220 EG15	180	34	–	119	295	305
	NU 220 EG15	180	34	–	119	295	305	
	NJ 2220 EG15	180	46	–	119	395	445	
	NU 2220 EG15	180	46	–	119	395	445	
	N 320 EM	215	47	191,5	–	450	425	
	NJ 320 EG15	215	47	–	127,5	450	425	
	NU 320 EG15	215	47	–	127,5	450	425	
	NJ 2320 EM	215	73	–	127,5	680	720	
	NU 2320 EG15	215	73	–	127,5	680	720	
	105	NJ 221 EG15	190	36	–	125,5	310	320
NU 221 EG15		190	36	–	125,5	310	320	
NU 221 EM		190	36	–	125,5	310	320	
NU 321 EM		225	49	–	133	435	495	
110	N 222 EM	200	38	180,5	–	345	365	
	NJ 222 EG15	200	38	–	132,5	345	365	
	NU 222 EG15	200	38	–	132,5	345	365	
	NU 2222 EG15	200	53	–	132,5	455	520	
	N 322 EM	240	50	211	–	520	510	
	NJ 322 EG15	240	50	–	143	495	475	
	NU 322 EG15	240	50	–	143	495	475	
	NJ 2322 EM	240	80	–	143	750	800	
	NU 2322 EM	240	80	–	143	750	800	

■ Single-row cylindrical roller bearings (continued)

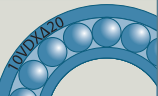

References	  		d3 max	D1 min	r1 max	r2 max	kg
	rpm*	rpm*	mm	mm	mm	mm	
N 218 EG15	3400	4200	101	149	2	2	2,360
NJ 218 EG15	3400	4200	101	149	2	2	2,410
NU 218 EG15	3400	4200	101	149	2	2	2,360
NJ 2218 EG15	3400	4200	101	149	2	2	3,230
NU 2218 EG15	3400	4200	101	149	2	2	3,170
N 318 EM	2900	3500	104	176	3	3	6,210
NJ 318 EG15	2900	3500	104	176	3	3	5,500
NU 318 EG15	2900	3500	104	176	3	3	5,390
NJ 2318 EM	2800	3500	104	176	3	3	9,100
NU 2318 EG15	2800	3500	104	176	3	3	8,040
N 219 EG15	3200	3900	107	158	2,1	2,1	2,750
NJ 219 EG15	3200	3900	107	158	2,1	2,1	2,940
NU 219 EG15	3200	3900	107	158	2,1	2,1	2,880
NJ 2219 EG15	3200	3900	107	158	2,1	2,1	3,900
NU 2219 EG15	3200	3900	107	158	2,1	2,1	3,900
N 319 EM	2800	3300	109	186	3	3	7,200
NJ 319 EG15	2800	3300	109	186	3	3	6,440
NU 319 EG15	2800	3300	109	186	3	3	6,320
NU 2319 EG15	2600	3300	109	186	3	3	9,400
N 220 EG15	3100	3700	112	168	2,1	2,1	3,320
NJ 220 EG15	3100	3700	112	168	2,1	2,1	3,480
NU 220 EG15	3100	3700	112	168	2,1	2,1	3,550
NJ 2220 EG15	3100	3700	112	168	2,1	2,1	4,850
NU 2220 EG15	3100	3700	112	168	2,1	2,1	4,800
N 320 EM	2600	3100	114	201	3	3	8,800
NJ 320 EG15	2600	3100	114	201	3	3	7,760
NU 320 EG15	2600	3100	114	201	3	3	7,610
NJ 2320 EM	2500	3100	114	201	3	3	13,500
NU 2320 EG15	2500	3100	114	201	3	3	12,000
NJ 221 EG15	2900	3500	117	178	2,1	2,1	4,083
NU 221 EG15	2900	3500	117	178	2,1	2,1	4,100
NU 221 EM	2900	3500	117	178	2,1	2,1	4,620
NU 321 EM	2500	2900	119	211	3	3	9,950
N 222 EM	2800	3300	122	188	2,1	2,1	5,500
NJ 222 EG15	2800	3300	122	188	2,1	2,1	4,930
NU 222 EG15	2800	3300	122	188	2,1	2,1	4,840
NU 2222 EG15	2800	3300	125	188	2,1	2,1	6,800
N 322 EM	2300	2800	124	226	3	3	11,900
NJ 322 EG15	2300	2800	124	226	3	3	10,330
NU 322 EG15	2300	2800	124	226	3	3	10,500
NJ 2322 EM	2200	2800	124	226	3	3	18,600
NU 2322 EM	2200	2800	124	226	3	3	18,300

* These are the speed limits according to the SNR concept (see pages 85 to 87).





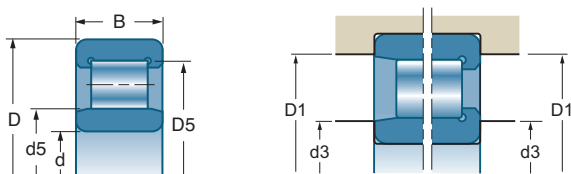

Cylindrical roller bearings (continued)

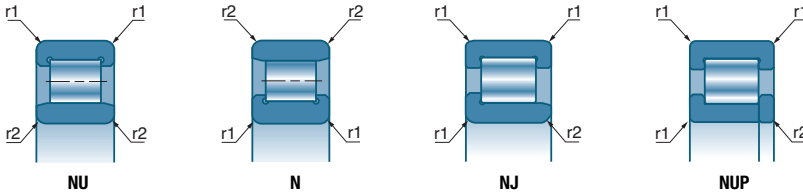

d		D	B	D5 (Ø above the rollers)	d5 (Ø below the rollers)		
						10°N	10°N
mm	References	mm	mm	mm	mm		
120	NJ 224 EG15	215	40	—	143,5	390	415
	NU 224 EG15	215	40	—	143,5	390	415
	NU 2224 EG15	215	58	—	143,5	530	610
	N 324 EM	260	55	230	—	610	600
	NJ 324 EG15	260	55	—	154	610	600
	NU 324 EG15	260	55	—	154	610	600
	NJ 2324 EM	260	86	—	154	930	1010
	NU 2324 EM	260	86	—	154	930	1010
	130	NJ 226 EG15	230	40	—	153,5	425
NU 226 EG15		230	40	—	153,5	425	445
NU 2226 EG15		230	64	—	153,5	620	730
N 326 EM		280	58	247	—	720	720
NJ 326 EG15		280	58	—	167	680	670
NU 326 EG15		280	58	—	167	680	670
NJ 2326 EM		280	93	—	167	1080	1220
NU 2326 EM		280	93	—	167	1080	1220
140		N 228 EM	250	42	225	—	460
	NJ 228 EM	250	42	—	169	460	510
	NU 228 EM	250	42	—	169	460	510
	N 328 EM	300	62	264	—	790	800
	NU 328 EM	300	62	—	180	790	800
	NU 2328 EM	300	102	—	180	1210	1390
150	NJ 230 EM	270	45	—	182	520	590
	NU 230 EM	270	45	—	182	520	590
	N 330 EM	320	65	283	—	900	930
	NU 330 EM	320	65	—	193	900	930
	NU 2330 EM	320	108	—	193	1380	1600
160	NJ 232 EM	290	48	—	195	590	670
	NU 232 EM	290	48	—	195	590	670
	NU 2332 EM	340	114	—	204	1320	1830
170	NU 234 EM	310	52	—	207	700	780
	N 334 EM	360	72	318	—	965	1220
180	NU 236 EM	320	52	—	217	730	830
190	NU 238 EM	340	55	—	230	680	930
	N 338 EM	400	78	353	—	1150	1490
200	N 340 EM	420	80	370	—	1180	1530

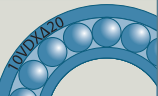
■ Single-row cylindrical roller bearings (continued)



References	  		d3 max	D1 min	r1 max	r2 max	 kg
	rpm*	rpm*	mm	mm	mm	mm	
NJ 224 EG15	2500	3100	132	203	2,1	2,1	5,890
NU 224 EG15	2500	3100	132	203	2,1	2,1	5,780
NU 2224 EG15	2500	3100	135	203	2,1	2,1	8,400
N 324 EM	2100	2600	134	246	3	3	15,110
NJ 324 EG15	2100	2600	134	246	3	3	13,540
NU 324 EG15	2100	2600	134	246	3	3	13,200
NJ 2324 EM	2000	2600	134	246	3	3	23,800
NU 2324 EM	2000	2600	134	246	3	3	23,200
NJ 226 EG15	2400	2900	144	216	3	3	6,600
NU 226 EG15	2400	2900	144	216	3	3	6,480
NU 2226 EG15	2400	2900	144	216	3	3	10,400
N 326 EM	2000	2400	147	263	4	4	18,440
NJ 326 EG15	2000	2400	147	263	4	4	16,700
NU 326 EG15	2000	2400	147	263	4	4	16,400
NJ 2326 EM	1900	2400	147	263	4	4	29,200
NU 2326 EM	1900	2400	147	263	4	4	28,800
N 228 EM	2200	2700	154	236	3	3	9,490
NJ 228 EM	2200	2700	154	236	3	3	9,650
NU 228 EM	2200	2700	154	236	3	3	9,500
N 328 EM	1800	2200	157	283	4	4	22,510
NU 328 EM	1800	2200	157	283	4	4	22,450
NU 2328 EM	1800	2200	157	283	4	4	36,000
NJ 230 EM	2000	2500	164	256	3	3	12,200
NU 230 EM	2000	2500	164	256	3	3	12,000
N 330 EM	1700	2100	167	303	4	4	26,800
NU 330 EM	1700	2100	167	303	4	4	27,400
NU 2330 EM	1600	2100	167	303	4	4	43,200
NJ 232 EM	1900	2300	174	276	3	3	15,100
NU 232 EM	1900	2300	174	276	3	3	14,900
NU 2332 EM	1500	1900	177	323	4	4	51,500
NU 234 EM	1800	2100	187	293	4	4	18,130
N 334 EM	1500	1800	187	343	4	4	37,900
NU 236 EM	1700	2000	197	303	4	4	18,910
NU 238 EM	1600	1900	207	323	4	4	23,100
N 338 EM	1400	1600	210	380	5	5	50,500
N 340 EM	1300	1500	220	400	5	5	57,000

* These are the speed limits according to the SNR concept (see pages 85 to 87).



Tapered roller bearings



Tapered roller bearings	314
■ Definition and capabilities	314
■ Series	315
■ Variants	315
■ Tolerances and clearances	316
■ Design criteria	318
■ Installation/assembly criteria	320
■ Prefixes and suffixes	321
■ Characteristics	322

Tapered roller bearings

Definition and capabilities

→ Definition

Tapered roller bearings with a single row of rollers are always mounted opposing another bearing of the same type to provide rigid assemblies, particularly when preloaded.

■ Cages

Tapered roller bearings are usually equipped with a pressed steel cage. In some cases with a synthetic material cage.

■ Contact angle

The rings of this bearing are detachable: the outer ring (cup) is not joined to the rest of the bearing which is made up of the inner ring (cone) and rollers held on the cone by the cage. A tapered roller bearing can accept axial loads in one direction only. It must be mounted in opposition with a bearing of the same type.

ISO 355 Standard defines the different series of tapered roller bearings with contact angles of 10 to 30°. For a given radial load, the greater the angle of the cup, the greater the axial load that the bearing can withstand. SNR has adopted designations in accordance with this standard for the new "intermediate" series and has kept the former designations for the other series.

→ Capabilities

■ Loads and speeds

The tapered roller bearing is an angular contact bearing that can withstand high radial and axial loads.

■ Misalignment

The shape of the contacting profiles allows misalignment in the range of 0.06°.

Series

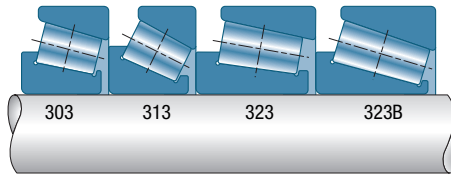
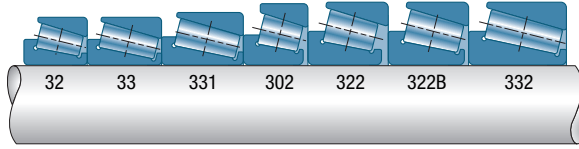

Variants

■ Special chamfer

Special chamfer on the large face of the cone to adapt to the large fillet radius of the shoulders of shafts such as those of wheel axles.

■ Flange on cup

■ Matched bearings

They are made up of two bearings and usually two spacers to form a single assembly. The elements of a given matched assembly cannot be exchanged with those of another assembly.

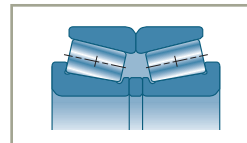
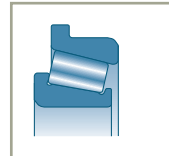

Tapered roller bearings *(continued)*

Tolerances and clearance

→ Tolerances

These bearings are supplied in standard precision with tolerances in accordance with ISO 492 Standard. They can be supplied on request with specific tolerances on one or more dimensions or characteristics.

→ Clearances

■ Axial clearance

As these bearings are always mounted in opposition, the axial clearance is determined by the adjustment of the bearings at installation. That is to say by the adjustment of the relative position of the cones with respect to the cups. The adjustment determines a mechanical clearance (positive clearance) or a pre-load (negative clearance).

■ Types of assembly

Face-to-face assembly (O)

This arrangement is to be used in applications involving temperature variations, or when the points of load application of the two bearings need to be as far apart as possible. It more specifically enables the creation of compact assemblies with either pre-loading or clearance.

The adjustment is made on the distance d_i between the cones of the two bearings which is determined by either a spacer length or an adjustment nut.

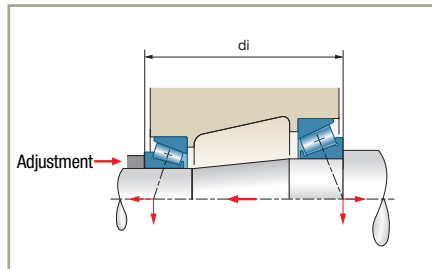

Back-to-back assembly (X)

To install a shaft fully equipped with the bearings in a housing.

The adjustment is made on the distance D_e between the cups of the two bearings, and is determined by shims or an adjustment nut.

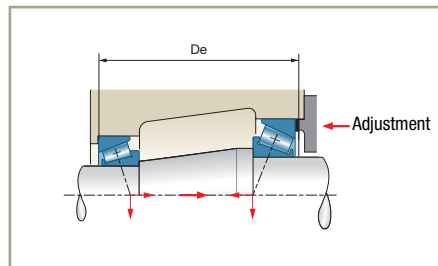

■ Relation between the axial clearance J_a and the radial clearance J_r of a bearing

$$J_a = 1.25 \cdot Y \cdot J_r$$

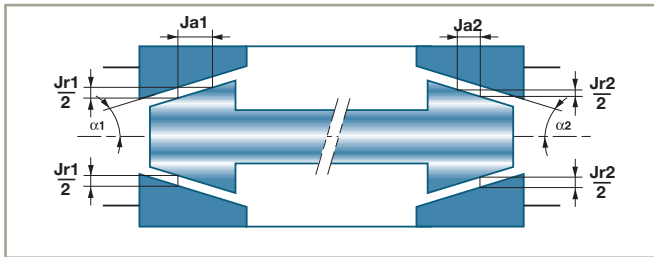

■ Pre-load

Tapered roller bearings are preloaded whenever one wants to ensure the axial stiffness of the assembly (bevel gear bearings, machine-tool spindle bearings, etc.). The nominal value of the pre-load is fixed for each application according to the loading conditions and the characteristics of the chosen bearings.

Consult SNR for the preparation of a preloaded bearing file.

SNR establishes two characteristic curves for each bearing reference:

- The axial penetration curve that characterises the bearing stiffness which depends on the contact angle, the number of rollers, and their effective length.

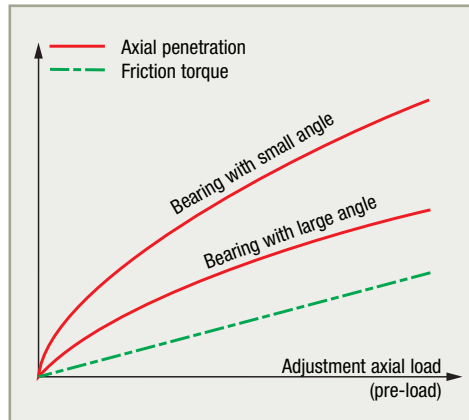

- The friction torque curve which enables to check that the pre-loading adjustment is correct using a torque gauge

■ Axial clearance on assembly for two separate bearings

As these bearings are always mounted in opposition, their internal clearance is determined by the adjustment on assembly that determines the axial clearance of the shaft.

For information, the relation between the axial clearance and the corresponding radial clearance is given by the formula:

$$J_r = 0,8 / Y \cdot J_a \quad (Y = 0.4 \cot \alpha)$$

These bearings can be mounted with a pre-load if necessary to secure an axial stiffness of an assembly. The maximum speed in this case is reduced and depends on the pre-load value.

Consult SNR.

Tapered roller bearings *(continued)*

Design criteria

■ Bearing life

■ Shaft mounted on two single bearings

Equivalent dynamic load

The axial balance of the shaft depends not only on the forces applied, but also on the forces induced by the radial loads applied on each bearing.

Equivalent static load

Its value P_0 is the greater of the two values obtained using the following formula:

$$P_0 = F_r$$

$$P_0 = 0.5 F_r + Y_0 \cdot F_a$$

■ Shaft with one of its two assemblies made up by two matched non-preloaded bearings assembled in an **O** or **X** arrangement

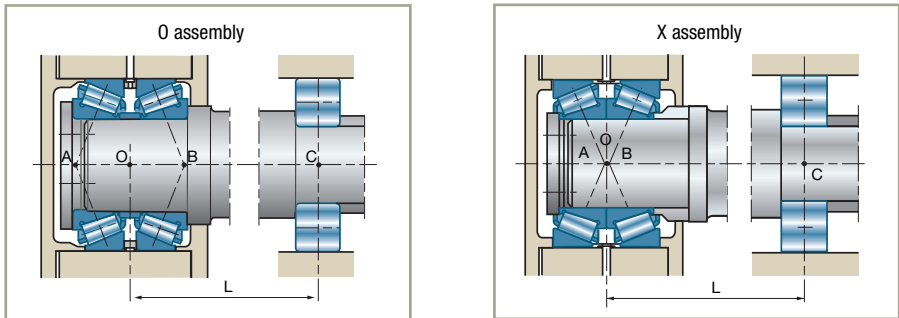

This assembly is considered as a single double-row roller bearing which centre O is the mid-point of the distance AB between the load application points. The assembly of a shaft with this type of assembly is hyperstatic (3 seating points: A. B. C) and can only be likened approximately to an arrangement of two assemblies if the distance AB is less than $L/5$ and the stiffness of the assembly is satisfactory (misalignment $< 0.06^\circ$). In all other cases, consult SNR.

Equivalent dynamic load of the double pillow block (ISO 281 Standard)

$$P = F_r + 1.1 Y \cdot F_a \quad \text{if } F_a / F_r \leq e$$

$$P = 0.67 F_r + 1.68 Y \cdot F_a \quad \text{if } F_a / F_r > e$$

Basic dynamic capacity of the double bearing

The basic dynamic capacity of an assembly of two identical bearings is:

$$C_e = 1.715 C$$

Equivalent static capacity of the double pillow block

$$P_0 = F_r + 1.1 Y \cdot F_a$$

Basic static capacity of the double pillow block

The static capacity of the assembly of two identical bearings is twice that of a single bearing.

$$C_{0e} = 2 C_0$$

■ Calculation of preloaded bearings

The values of the induced forces involved in the axial equilibrium of two bearings depend on the applied pre-load and the bearing stiffness characteristics. Consequently, the calculation of the equivalent load on each bearing is complex and must be performed by the SNR Technical Service.



Tapered roller bearings *(continued)*

Installation/assembly criteria

■ Interchangeability of elements of the same reference

As the cones and cups of tapered roller bearings are separable, ISO has established:

- the nominal dimensions of the small diameter of the cup raceway (E)
- the contact angle (α)

Interchangeability of SNR elements

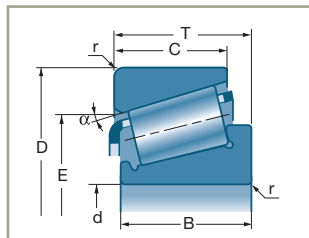

The cones and cups of the same reference are totally interchangeable, with the total width of the bearing (dimension T) remaining within the standard tolerances (ISO 492).

Interchangeability of an SNR element with an element of another make

Interchangeability is possible if the non-SNR elements comply with ISO 355 Standard, particularly dimensions α and E. However, as the tolerances on these dimensions, the raceway profile shapes, the quality of steel and the surface conditions are specific to each manufacturer. The performance of such assemblies risks can be significantly reduced. Such assemblies should therefore be avoided.

Some SNR references in old designs are not interchangeable with other makes. They are identified in the "List of Standard Bearings".

■ Adjustment parameters

The assembly of standard bearings always requires an adjustment due to the fact that their elements can be separated.

The adjustment depends on the assembly dimensions and their tolerances, which are:

The functional dimensions of the bearing

- Bore d
- Outer diameter D
- The distance between the cone and cup faces of a given bearing: dimension T

The functional dimensions of the assembly

- The distance between the cup shoulders (D_e)
- The distance between the cone shoulders (d_i)
- The diameters of the shaft and housing seating surfaces

The generally accepted tolerance for a given clearance (positive or negative) makes it necessary to repeat the adjustment operation for each assembly, taking in consideration amplitude of standard bearing tolerances and the assembly dimensions.

One then adjusts one of the shoulder distances (D_e) or (d_i) at each operation to compensate for the variations in the other dimensions of the assembly.

Adjustment is a relatively long and repetitive operation that has to be performed by specialised personnel capable of ensuring its precision and reliability.

■ Installation without adjustment

In many high volume production assembly operations, the dimensional tolerances have a reduced normal statistical distribution. In such cases, by using bearings which also have reduced tolerances, mountings will have a 99.73% probability that no further adjustment will be required, which is suitable for most applications.

Main applications: vehicle wheels and gear boxes.

The bearings are usually fitted close to each other in an O arrangement.

■ The two possibilities of adjustment-free assembly are:

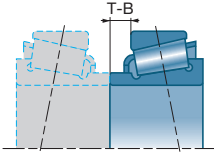
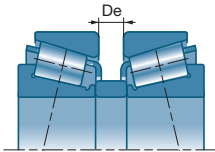
Type of assembly	Pre-adjusted bearings	Matched assembly
Adjustment schematic		
Bearing characteristics	<ul style="list-style-type: none"> ▶ Reduced tolerance on the position of the cone with respect to the large face of the cup (dimension T - B). ▶ Interchangeable cone and cup. ▶ Cone usually extended to avoid the need for a spacer. 	<ul style="list-style-type: none"> ▶ Set of two pre-adjusted bearings with a reduced tolerance on the distance of the 2 cups (0.03 mm approximately). ▶ Elements not interchangeable with those of another assembly.
Assembly characteristics	<ul style="list-style-type: none"> ▶ Assembly of large series in O arrangement. ▶ Tolerance of about 0.05 mm max. on the distance (De) of the cup shoulders. 	<ul style="list-style-type: none"> ▶ Assembly of large or medium series. ▶ Tolerance of about 0.05 mm max. on the distance (De) of the cup shoulders.
Axial clearance tolerances	<ul style="list-style-type: none"> ▶ Tolerance of the order of 0.15 / 0.20 mm with a probability of 99.7%. The clearances outside this probability (0.3%) lie within a theoretical range of 0.4 to 0.6 mm approx. 	<ul style="list-style-type: none"> ▶ Tolerance of the order of 0.10 / 0.15 mm with a probability of 99.7%. The clearances outside this probability (0.3 %) lie within a theoretical range of 0.25 to 0.4 mm approx.

Prefixes and suffixes

■ Prefixes

R	Special chamfer on the large face of the inner ring (cone)
----------	--

■ Suffixes

B	Suffix for series 322 and 323 with increased angle
A. C	Internal design indices
T	Flange on outer ring (cup)
P6X	Bearing whose tolerance on dimension T complies with precision class 6X



Tapered roller bearings (continued)

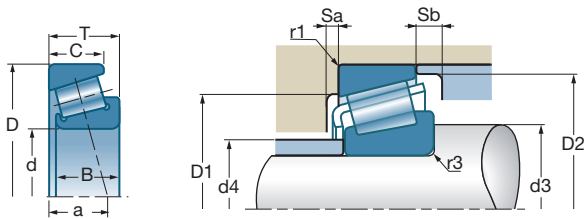



d		D	B	C	T	a			e	Y	Yo		
												rpm*	rpm*
mm	Ref.	mm	mm	mm	mm	mm	10°N	10°N					
15	30202A	35	11	10,0	11,75	8,40	15,80	14,50	0,32	1,88	1,03	10000	15000
17	30203A	40	12	11,0	13,25	9,90	21,2	21,3	0,35	1,74	0,96	9500	13000
	32203A	40	16	14,0	17,25	11,25	31,0	31,0	0,31	1,92	1,06	9200	12000
	30303A	47	14	12,0	15,25	10,40	29,7	27,2	0,29	2,11	1,16	8400	11000
20	30204A	47	14	12,0	15,25	11,20	28,2	30,6	0,35	1,74	0,96	8000	11000
	30304A	52	15	13,0	16,25	11,20	34,7	33,2	0,30	2,00	1,10	7500	10000
	32304A	52	21	18,0	22,25	13,60	44,6	46,3	0,30	2,00	1,10	7700	10000
25	32005V	47	15	11,5	15,00	11,50	28,5	31,5	0,43	1,39	0,77	7600	10000
	30205A	52	15	13,0	16,25	12,60	35,4	39,4	0,37	1,60	0,88	7100	10000
	32205B	52	18	15,0	19,25	16,75	41,5	49,0	0,58	1,03	0,57	7200	9500
	33205A	52	22	18,0	22,00	14,00	52,5	57,5	0,35	1,71	0,94	7300	9800
	30305A	62	17	15,0	18,25	13,00	49,2	48,1	0,30	2,00	1,10	6200	8600
	32305A	62	24	20,0	25,25	15,90	64,6	68,8	0,30	2,00	1,10	6300	8200
30	32006C	55	17	13,0	17,00	13,50	38,5	45,0	0,43	1,39	0,77	6400	8000
	30206A	62	16	14,0	17,25	13,80	45,4	50,5	0,37	1,60	0,88	5900	8400
	32206C	62	20	17,0	21,25	14,75	50,0	55,0	0,37	1,60	0,88	5800	8100
	33206A	62	25	19,5	25,00	16,00	71,9	77,0	0,34	1,76	0,97	6300	8400
	30306A	72	19	16,0	20,75	15,30	61,7	63,1	0,31	1,90	1,05	5300	7400
	31306A	72	19	14,0	20,75	23,10	52,5	60,3	0,83	0,73	0,40	5100	7000
	32306A	72	27	23,0	28,75	18,90	85,5	96,4	0,32	1,90	1,05	5400	7000
35	32007C	62	18	14,0	18,00	15,00	46,5	56,0	0,45	1,32	0,73	5600	7900
	30207A	72	17	15,0	18,25	15,25	58,0	62,0	0,37	1,60	0,88	5100	7200
	32207C	72	23	19,0	24,25	18,25	70,0	80,0	0,37	1,60	0,88	4900	6900
	32207B	72	23	19,0	24,25	21,75	66,0	81,0	0,58	1,03	0,57	5200	6900
	33207A	72	28	22,0	28,00	18,50	96,8	109,0	0,35	1,70	0,94	5500	7400
	30307A	80	21	18,0	22,75	16,90	78,8	82,6	0,31	1,90	1,05	4700	6600
	31307A	80	21	15,0	22,75	25,80	68,5	76,3	0,83	0,73	0,40	4500	6200
	32307A	80	31	25,0	32,75	20,50	103,6	118,3	0,31	1,90	1,05	4800	6300
	32307B	80	31	25,0	32,75	25,25	95,0	112,0	0,55	1,10	0,60	4600	6300
	40	32008C	68	19	14,5	19,00	15,00	53,0	65,0	0,38	1,58	0,87	5000
33108A		75	26	20,5	26,00	18,00	84,8	110,3	0,35	1,69	0,93	4600	6400
30208A		80	18	16,0	19,25	16,90	63,0	74,0	0,37	1,60	0,88	4500	6500
32208C		80	23	19,0	24,75	19,75	78,0	88,0	0,37	1,60	0,88	4300	6100
33208A		80	32	25,0	32,00	21,00	113,9	132,0	0,36	1,68	0,92	4900	6600
30308A		90	23	20,0	25,25	19,50	95,2	107,5	0,35	1,74	0,96	4100	5800
31308A		90	23	17,0	25,25	29,10	84,9	95,8	0,83	0,73	0,40	3900	5500
32308A		90	33	27,0	35,25	23,40	120,8	147,1	0,35	1,74	0,96	4200	5500

* These are the speed limits according to the SNR concept (see pages 85 to 87).

Characteristics

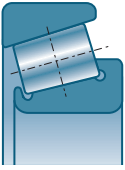
■ Single-row tapered roller bearings (mm)



	D1 min	D1 max	D2 min	d3 min	d4 max	Sa min	Sb min	r1 max	r3 max		ISO
Ref.	mm	mm	mm	mm	mm	mm	mm	mm	mm	kg	
30202A	29,0	29,0	32,0	19,0	20,0	2,0	1,8	1,0	1,0	0,053	
30203A	34,0	34,0	37,0	23,0	23,0	2,0	2,3	1,0	1,0	0,076	2DB
32203A	33,6	34,2	37,9	23,8	22,1	3,1	0,5	1,0	1,0	0,103	2DD
30303A	40,0	41,0	42,0	23,0	25,0	2,0	3,2	1,0	1,0	0,121	2FB
30204A	40,0	41,0	43,0	26,0	27,0	2,0	3,3	1,0	1,0	0,125	2DB
30304A	44,0	45,0	47,0	27,0	28,0	2,0	3,2	1,5	1,5	0,179	2FB
32304A	43,0	45,0	47,0	27,0	27,0	3,0	4,0	1,5	1,5	0,238	2FD
32005V	40,0	42,0	44,0	30,0	30,0	3,0	3,5	0,6	0,6	0,110	4CC
30205A	44,0	46,0	48,0	31,0	31,0	2,0	3,3	1,0	1,0	0,154	3CC
32205B	41,0	46,0	49,0	31,0	30,0	3,2	4,0	1,0	1,0	0,192	5CD
33205A	43,0	46,0	49,0	31,0	30,0	4,0	4,0	1,0	1,0	0,222	2DE
30305A	54,0	55,0	57,0	32,0	34,0	2,0	3,2	1,5	1,5	0,265	2FB
32305A	53,0	55,0	57,0	32,0	33,0	3,0	5,0	1,5	1,5	0,378	2FD
32006C	48,0	49,0	52,0	36,0	35,0	3,7	4,0	1,0	1,0	0,165	4CC
30206A	53,0	56,0	57,0	36,0	37,0	2,0	3,2	1,0	1,0	0,238	3DB
32206C	52,0	56,0	59,0	36,0	37,0	3,2	4,0	1,0	1,0	0,282	3DC
33206A	53,0	56,0	59,0	36,0	36,0	5,0	5,5	1,0	1,0	0,353	2DE
30306A	62,0	65,0	66,0	37,0	40,0	3,0	4,5	1,5	1,5	0,400	2FB
31306A	55,0	65,0	68,0	37,0	40,0	3,0	6,5	1,5	1,5	0,395	7FB
32306A	59,0	65,0	66,0	37,0	39,0	4,0	5,5	1,5	1,5	0,579	2FD
32007C	54,0	56,0	59,0	41,0	40,0	4,0	4,0	1,0	1,0	0,219	4CC
30207A	62,0	65,0	67,0	42,0	44,0	3,0	3,0	1,5	1,5	0,328	3DB
32207C	61,0	65,0	67,0	42,0	43,0	3,6	5,5	1,5	1,5	0,430	3DC
32207B	56,0	65,0	68,0	42,0	42,0	3,0	5,0	1,5	1,5	0,436	5DC
33207A	61,0	65,0	68,0	42,0	42,0	5,0	6,0	1,5	1,5	0,542	2DE
30307A	70,0	71,0	74,0	44,0	45,0	3,0	4,5	1,5	2,0	0,550	2FB
31307A	62,0	71,0	76,0	44,0	44,0	4,0	7,5	1,5	2,0	0,526	7FB
32307A	66,0	71,0	74,0	44,0	44,0	4,0	7,5	1,5	2,0	0,827	2FE
32307B	61,0	71,0	76,0	44,0	42,0	5,3	7,5	1,5	2,0	0,741	5FE
32008C	60,0	62,0	65,0	46,0	46,0	4,7	4,5	1,0	1,0	0,265	3CD
33108A	65,0	68,0	71,0	47,0	47,0	4,0	5,5	1,5	1,5	0,505	2CE
30208A	69,0	73,0	74,0	47,0	49,0	3,0	3,8	1,5	1,5	0,422	3DB
32208C	68,0	73,0	75,0	47,0	48,0	5,1	5,5	1,5	1,5	0,508	3DC
33208A	67,0	73,0	76,0	47,0	47,0	5,0	7,0	1,5	1,5	0,733	2DE
30308A	77,0	81,0	82,0	49,0	52,0	3,0	5,0	1,5	2,0	0,759	2FB
31308A	71,0	81,0	86,0	49,0	51,0	4,0	8,0	1,5	2,0	0,747	7FB
32308A	73,0	81,0	82,0	49,0	50,0	4,0	8,0	1,5	2,0	1,040	2FD



■ Single-row tapered roller bearings (mm) (continued)

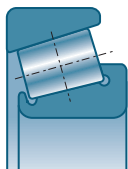

Ref.	D1 min	D1 max	D2 min	d3 min	d4 max	Sa min	Sb min	r1 max	r3 max	kg	ISO
	mm	mm	mm	mm	mm	mm	mm	mm	mm		
32009V	67,0	69,0	72,0	49,0	51,0	4,0	4,5	1,0	1,0	0,320	3CC
33109A	69,0	73,0	77,0	52,0	52,0	4,0	5,5	1,5	1,5	0,551	3CE
30209C	74,0	78,0	80,0	52,0	54,0	3,2	4,5	1,5	1,5	0,463	3DB
32209A	73,0	78,0	80,0	52,0	53,0	3,0	5,5	1,5	1,5	0,641	3DC
32209B	70,0	78,0	82,0	52,0	53,0	4,0	5,5	1,5	1,5	0,576	5DC
33209A	72,0	78,0	81,0	52,0	52,0	5,0	7,0	1,5	1,5	0,803	3DE
30309A	86,0	91,0	92,0	54,0	59,0	3,0	5,0	1,5	2,0	1,030	2FB
31309A	79,0	91,0	95,0	54,0	56,0	4,0	9,0	1,5	2,0	0,951	7FB
32309A	82,0	91,0	93,0	54,0	56,0	4,0	8,0	1,5	2,0	1,400	2FD
32309B	76,0	91,0	94,0	54,0	55,0	5,0	8,0	1,5	2,0	1,400	5FD
32010A	72,0	74,0	77,0	56,0	56,0	4,0	4,5	1,0	1,0	0,360	3CC
33110A	74,0	78,0	82,0	57,0	56,0	4,0	6,0	1,5	1,5	0,574	3CE
30210C	79,0	83,0	85,0	57,0	58,0	3,3	4,5	1,5	1,5	0,527	3DB
32210A	78,0	83,0	85,0	57,0	58,0	3,0	5,5	1,5	1,5	0,667	3DC
33210A	77,0	83,0	87,0	57,0	57,0	5,0	7,5	1,5	1,5	0,875	3DE
30310A	95,0	100,0	102,0	60,0	65,0	4,0	6,0	2,0	2,5	1,290	2FB
31310A	87,0	100,0	104,0	60,0	62,0	4,0	10,0	2,0	2,5	1,240	7FB
32310A	90,0	100,0	102,0	60,0	62,0	5,0	9,0	2,0	2,5	1,860	2FD
32011A	81,0	83,0	86,0	62,0	63,0	4,0	5,5	1,5	1,5	0,592	3CC
33011A	81,0	83,0	86,0	62,0	63,0	5,0	6,0	1,5	1,5	0,667	2CE
33111A	83,0	88,0	91,0	62,0	62,0	5,0	7,0	1,5	1,5	0,863	3CE
30211A	88,0	91,0	94,0	64,0	64,0	4,0	4,5	1,5	2,0	0,732	3DB
32211A	87,0	91,0	95,0	64,0	63,0	4,0	5,5	1,5	2,0	0,915	3DC
33211A	85,0	91,0	96,0	64,0	62,0	6,0	8,0	1,5	2,0	1,160	3DE
30311A	104,0	110,0	111,0	65,0	71,0	4,0	6,5	2,0	2,5	1,610	2FB
31311A	94,0	110,0	113,0	65,0	68,0	4,0	10,5	2,0	2,5	1,580	7FB
32311A	99,0	110,0	111,0	65,0	68,0	5,0	10,5	2,0	2,5	2,350	2FD
32311B	91,0	110,0	112,0	65,0	65,0	5,0	10,5	2,0	2,5	2,320	5FD
32012A	85,0	88,0	91,0	67,0	67,0	4,0	5,5	1,5	1,5	0,632	4CC
33012A	85,0	88,0	90,0	67,0	67,0	5,0	6,0	1,5	1,5	0,715	2CE
33112A	88,0	93,0	96,0	67,0	67,0	5,0	7,0	1,5	1,5	0,917	3CE
30212A	96,0	101,0	103,0	69,0	70,0	4,0	4,5	1,5	2,0	0,967	3EB
32212A	95,0	101,0	104,0	69,0	69,0	4,0	5,5	1,5	2,0	1,170	3EC
33212A	93,0	101,0	105,0	69,0	69,0	6,0	9,0	1,5	2,0	1,540	3EE
30312A	112,0	118,0	120,0	72,0	77,0	5,0	7,5	2,5	3,0	2,030	2FB
31312A	103,0	118,0	123,0	72,0	73,0	5,0	11,5	2,5	3,0	2,000	7FB
32312A	107,0	118,0	120,0	72,0	74,0	6,0	11,5	2,5	2,0	2,924	2FB



Tapered roller bearings (continued)

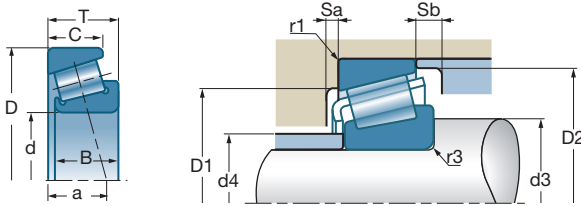

d		D	B	C	T	a			e	Y	Yo		
												rpm*	rpm*
mm	Ref.	mm	mm	mm	mm	mm	10 ³ N	10 ³ N					
65	32013A	100	23	17,5	23,00	22,50	83,0	128,0	0,46	1,31	0,72	3400	4600
	33013A	100	27	21,0	27,00	21,50	107,9	156,0	0,35	1,72	0,95	3400	4600
	33113A	110	34	26,5	34,00	26,00	159,3	211,0	0,39	1,55	0,85	3300	4400
	30213A	120	23	20,0	24,75	23,80	126,3	152,7	0,40	1,48	0,81	2900	4100
	32213A	120	31	27,0	32,75	27,30	168,7	221,8	0,40	1,48	0,82	2800	3900
	33213A	120	41	32,0	41,00	29,50	202,0	280,0	0,39	1,54	0,85	2800	4000
	30313A	140	33	28,0	36,00	28,50	203,0	238,0	0,35	1,74	0,96	2800	3700
	31313A	140	33	23,0	36,00	44,00	191,4	204,0	0,83	0,73	0,40	2500	3300
	32313A	140	48	39,0	51,00	34,50	273,0	350,0	0,35	1,74	0,96	2800	3700
	32313B	140	48	39,0	51,00	41,50	275,0	375,0	0,55	1,10	0,60	2600	3500
70	32014A	110	25	19,0	25,00	24,00	105,0	160,0	0,43	1,38	0,76	3200	4200
	33014A	110	31	25,5	31,00	22,50	127,0	204,0	0,28	2,11	1,16	3200	4200
	30214A	125	24	21,0	26,25	25,90	138,3	173,7	0,42	1,43	0,79	2800	4000
	32214A	125	31	27,0	33,25	28,90	173,1	237,1	0,42	1,43	0,79	2700	3800
	33214A	125	41	32,0	41,00	31,00	201,0	282,0	0,41	1,47	0,81	2900	3900
	30314A	150	35	30,0	38,00	30,00	230,0	272,0	0,35	1,74	0,96	2600	3500
	31314A	150	35	25,0	38,00	47,00	213,5	229,0	0,83	0,73	0,40	2300	3000
	32314A	150	51	42,0	54,00	36,50	310,0	405,0	0,35	1,74	0,96	2600	3500
	32314B	150	51	42,0	54,00	44,00	305,0	405,0	0,55	1,10	0,60	2400	3300
	75	32015A	115	25	19,0	25,00	25,50	106,0	167,0	0,46	1,31	0,72	3000
33015A		115	31	25,5	31,00	23,00	111,0	186,0	0,30	2,01	1,11	3000	4000
33115A		125	37	29,0	37,00	29,00	188,1	252,0	0,40	1,51	0,83	2800	3700
30215A		130	25	22,0	27,25	27,00	153,8	175,0	0,44	1,38	0,76	2700	3600
32215A		130	31	27,0	33,25	30,00	168,0	224,0	0,44	1,38	0,76	2700	3600
33215A		130	41	31,0	41,00	32,00	208,0	298,0	0,43	1,40	0,77	2700	3600
30315A		160	37	31,0	40,00	32,00	255,0	305,0	0,35	1,74	0,96	2400	3200
32315A		160	55	45,0	58,00	39,00	355,0	470,0	0,35	1,74	0,96	2400	3200
32315B		160	55	45,0	58,00	46,50	325,0	415,0	0,55	1,10	0,60	2300	3100
80		32016A	125	29	22,0	29,00	27,00	139,0	216,0	0,42	1,42	0,78	2800
	33016A	125	36	29,5	36,00	25,00	173,0	284,0	0,28	2,16	1,19	2800	3700
	33116A	130	37	29,0	37,00	30,50	179,0	276,0	0,42	1,44	0,79	2600	3500
	30216A	140	26	22,0	28,25	27,50	160,0	200,0	0,42	1,43	0,79	2500	3400
	32216A	140	33	28,0	35,25	31,00	199,0	265,0	0,42	1,43	0,79	2500	3400
	33216A	140	46	35,0	46,00	35,00	250,0	365,0	0,43	1,41	0,78	2500	3400
	30316A	170	39	33,0	42,50	34,00	291,0	350,0	0,35	1,74	0,96	2300	3000
85	32017A	130	29	22,0	29,00	28,50	142,0	224,0	0,44	1,36	0,75	2600	3500
	33017A	130	36	29,5	36,00	26,00	176,0	296,0	0,29	2,06	1,13	2600	3500
	33117A	140	41	32,0	41,00	33,00	211,0	330,0	0,41	1,48	0,81	2400	3300
	30217A	150	28	24,0	30,50	30,00	202,4	232,0	0,42	1,43	0,79	2400	3200

* These are the speed limits according to the SNR concept (see pages 85 to 87).

■ Single-row tapered roller bearings (mm) (continued)

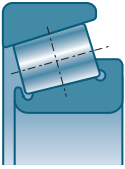

Ref.	D1 min	D1 max	D2 min	d3 min	d4 max	Sa min	Sb min	r1 max	r3 max	ISO	
	mm	mm	mm	mm	mm	mm	mm	mm	mm		
32013A	90,0	93,0	97,0	72,0	72,0	4,0	5,5	1,5	1,5	0,675	4CC
33013A	89,0	93,0	96,0	72,0	72,0	5,0	6,0	1,5	1,5	0,757	2CE
33113A	96,0	103,0	106,0	72,0	73,0	6,0	7,5	1,5	1,5	1,300	3DE
30213A	106,0	111,0	113,0	74,0	77,0	4,0	4,5	1,5	2,0	1,160	3EB
32213A	104,0	111,0	115,0	74,0	76,0	4,0	5,5	1,5	2,0	1,550	3EC
33213A	102,0	111,0	115,0	74,0	74,0	6,0	9,0	1,5	2,0	2,020	3EE
30313A	122,0	128,0	130,0	77,0	83,0	5,0	8,0	2,5	3,0	2,520	2GB
31313A	111,0	128,0	132,0	77,0	79,0	5,0	13,0	2,5	3,0	2,500	7GB
32313A	117,0	128,0	130,0	77,0	80,0	6,0	12,0	2,5	3,0	3,400	2GD
32313B	109,0	128,0	77,0	133,0	77,0	6,0	12,0	2,5	3,0	3,460	5GD
32014A	98,0	103,0	105,0	77,0	78,0	5,0	6,0	1,5	1,5	0,867	4CC
33014A	99,0	103,0	105,0	77,0	78,0	5,0	5,5	1,5	1,5	1,080	2CE
30214A	110,0	116,0	118,0	79,0	81,0	4,0	5,0	1,5	2,0	1,300	3EB
32214A	108,0	116,0	119,0	79,0	80,0	4,0	6,0	1,5	2,0	1,730	3EC
33214A	107,0	116,0	120,0	79,0	79,0	7,0	9,0	1,5	2,0	2,120	3EE
30314A	130,0	138,0	140,0	82,0	89,0	5,0	8,0	2,5	3,0	3,050	2GB
31314A	118,0	138,0	141,0	82,0	84,0	5,0	13,0	2,5	3,0	2,950	7GB
32314A	125,0	138,0	140,0	82,0	86,0	6,0	12,0	2,5	3,0	4,400	2GD
32314B	117,0	138,0	143,0	82,0	83,0	7,0	12,0	2,5	3,0	4,250	5GD
32015A	103,0	108,0	110,0	82,0	83,0	5,0	6,0	1,5	1,5	0,858	4CC
33015A	104,0	108,0	110,0	82,0	83,0	6,0	5,5	1,5	1,5	1,150	2CE
33115A	109,0	116,0	120,0	84,0	84,0	6,0	8,0	1,5	2,0	1,810	3DE
30215A	115,0	121,0	124,0	84,0	86,0	4,0	5,0	1,5	2,0	1,390	4DB
32215A	115,0	121,0	124,0	84,0	85,0	4,0	6,0	1,5	2,0	1,760	4DC
33215A	111,0	121,0	125,0	84,0	83,0	7,0	10,0	1,5	2,0	2,230	3EE
30315A	139,0	148,0	149,0	87,0	95,0	5,0	9,0	2,5	3,0	3,700	2GB
32315A	133,0	148,0	149,0	87,0	91,0	7,0	13,0	2,5	3,0	5,370	2GD
32315B	124,0	148,0	151,0	87,0	90,0	7,0	14,0	2,5	3,0	5,200	5GD
32016A	112,0	117,0	120,0	87,0	89,0	6,0	7,0	1,5	1,5	1,300	3CC
33016A	112,0	117,0	119,0	87,0	90,0	6,0	6,5	1,5	1,5	1,630	2CE
33116A	114,0	121,0	126,0	89,0	89,0	6,0	8,0	1,5	2,0	1,930	3DE
30216A	124,0	130,0	132,0	90,0	91,0	4,0	6,0	2,0	2,5	1,690	3EB
32216A	122,0	130,0	134,0	90,0	90,0	5,0	7,0	2,0	2,5	2,150	3EC
33216A	119,0	130,0	135,0	90,0	89,0	7,0	11,0	2,0	2,5	2,940	3EE
30316A	148,0	158,0	159,0	92,0	102,0	5,0	9,5	2,5	3,0	4,360	2GB
32017A	117,0	122,0	125,0	92,0	94,0	6,0	7,0	1,5	1,5	1,410	4CC
33017A	118,0	122,0	125,0	92,0	94,0	6,0	6,5	1,5	1,5	1,700	3CE
33117A	122,0	130,0	135,0	95,0	95,0	7,0	9,0	2,0	2,5	2,440	3DE
30217A	132,0	140,0	141,0	95,0	97,0	5,0	6,5	2,0	2,5	2,160	3EB



Tapered roller bearings (continued)

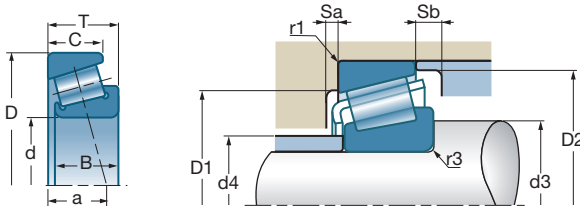



d		D	B	C	T	a			e	Y	Yo		
												rpm*	rpm*
mm	Ref.	mm	mm	mm	mm	mm	10 ³ N	10 ³ N				rpm*	rpm*
85	32217A	150	36	30,0	38,50	33,50	224,0	300,0	0,42	1,43	0,79	2400	3200
	33217A	150	49	37,0	49,00	37,50	284,0	420,0	0,42	1,43	0,79	2400	3200
	32317A	180	60	49,0	63,50	43,00	405,0	525,0	0,35	1,74	0,96	2100	2900
90	32018A	140	32	24,0	32,00	30,00	168,0	270,0	0,41	1,42	0,78	2500	3300
	33018A	140	39	32,5	39,00	28,00	215,0	360,0	0,27	2,23	1,23	2500	3300
	33118A	150	45	35,0	45,00	35,50	253,0	400,0	0,40	1,51	0,83	2300	3100
	30218A	160	30	26,0	32,50	32,00	208,0	267,0	0,42	1,43	0,79	2200	3000
	32218A	160	40	34,0	42,50	36,00	262,0	360,0	0,42	1,43	0,79	2200	3000
	32318A	190	64	53,0	67,50	45,50	450,0	595,0	0,35	1,74	0,96	2000	2700
95	32019A	145	32	24,0	32,00	31,50	171,0	280,0	0,44	1,36	0,75	2300	3100
	33019A	145	39	32,5	39,00	28,50	242,3	375,0	0,28	2,16	1,19	2300	3100
	30219A	170	32	27,0	34,50	34,00	226,0	290,0	0,42	1,43	0,79	2100	2800
	32219A	170	43	37,0	45,50	39,00	299,0	415,0	0,42	1,43	0,79	2100	2800
100	32020A	150	32	24,0	32,00	32,50	170,0	281,0	0,46	1,31	0,72	2200	3000
	33020A	150	39	32,5	39,00	29,50	224,0	390,0	0,29	2,09	1,15	2200	3000
	30220A	180	34	29,0	37,00	36,00	258,0	335,0	0,42	1,43	0,79	2000	2700
	32220A	180	46	39,0	49,00	41,50	330,0	465,0	0,42	1,43	0,79	2000	2700
105	32021A	160	35	26,0	35,00	34,50	201,0	335,0	0,44	1,35	0,74	2100	2800
	33021A	160	43	34,0	43,00	31,00	245,0	420,0	0,28	2,12	1,17	2100	2800
	30221A	190	36	30,0	39,00	38,00	287,0	380,0	0,42	1,43	0,79	1900	2500
	32221A	190	50	43,0	53,00	44,00	380,0	540,0	0,42	1,43	0,79	1900	2500
110	32022A	170	38	29,0	38,00	36,50	236,0	390,0	0,43	1,39	0,77	2000	2700
	33022A	170	47	37,0	47,00	33,50	288,0	500,0	0,29	2,09	1,15	2000	2700
	30222A	200	38	32,0	41,00	40,00	325,0	435,0	0,42	1,43	0,79	1800	2400
	32222A	200	53	46,0	56,00	47,00	420,0	605,0	0,42	1,43	0,79	1800	2400
120	T4CB120	170	25	19,5	27,00	34,00	150,0	235,0	0,47	1,27	0,70	1900	2600
	32024A	180	38	29,0	38,00	39,00	245,0	420,0	0,46	1,31	0,72	1800	2500
	33024A	180	48	38,0	48,00	36,00	293,0	520,0	0,31	1,97	1,08	1800	2400
	30224A	215	40	34,0	43,50	44,00	345,0	470,0	0,44	1,38	0,76	1700	2200
	32224A	215	58	50,0	61,50	51,50	460,0	680,0	0,44	1,38	0,76	1700	2200
130	T4CB130	185	27	21,0	29,00	38,00	180,0	280,0	0,47	1,27	0,70	1700	2400
	32026A	200	45	34,0	45,00	43,50	320,0	545,0	0,43	1,38	0,76	1700	2200
	30226A	230	40	34,0	43,75	45,50	375,0	505,0	0,44	1,38	0,76	1500	2000
	32226A	230	64	54,0	67,75	57,00	530,0	815,0	0,44	1,38	0,76	1500	2000

* These are the speed limits according to the SNR concept (see pages 85 to 87).

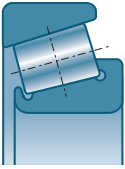
■ Single-row tapered roller bearings (mm) (continued)



	D1 min	D1 max	D2 min	d3 min	d4 max	Sa min	Sb min	r1 max	r3 max		ISO
Ref.	mm	mm	mm	mm	mm	mm	mm	mm	mm	kg	
32217A	130,0	140,0	142,0	95,0	96,0	5,0	8,5	2,0	2,5	2,750	3EC
33217A	128,0	140,0	144,0	95,0	95,0	7,0	12,0	2,0	2,5	3,620	3EE
32317A	150,0	166,0	167,0	99,0	103,0	8,0	14,5	3,0	4,0	7,450	2GD
32018A	125,0	131,0	134,0	99,0	100,0	6,0	8,0	1,5	2,0	1,691	3CC
33018A	127,0	131,0	135,0	99,0	100,0	7,0	6,5	1,5	2,0	2,200	2CE
33118A	130,0	140,0	144,0	100,0	100,0	7,0	10,0	2,0	2,5	3,220	3DE
30218A	140,0	150,0	150,0	100,0	103,0	5,0	6,5	2,0	2,5	2,700	3FB
32218A	138,0	150,0	152,0	100,0	102,0	5,0	8,5	2,0	2,5	3,500	3FC
32318A	157,0	176,0	177,0	104,0	108,0	8,0	14,5	3,0	4,0	8,780	2GD
32019A	130,0	136,0	140,0	104,0	105,0	6,0	8,0	1,5	2,0	1,784	4CC
33019A	131,0	136,0	139,0	104,0	104,0	7,0	6,5	1,5	2,0	2,300	2CE
30219A	149,0	158,0	159,0	107,0	110,0	5,0	7,5	2,5	3,0	3,160	3FB
32219A	145,0	158,0	161,0	107,0	108,0	5,0	8,5	2,5	3,0	4,200	3FC
32020A	134,0	141,0	144,0	109,0	109,0	6,0	8,0	1,5	2,0	1,880	4CC
33020A	135,0	141,0	143,0	109,0	108,0	7,0	6,5	1,5	2,0	2,310	2CE
30220A	157,0	168,0	168,0	112,0	116,0	5,0	8,0	2,5	3,0	3,700	3FB
32220A	154,0	168,0	171,0	112,0	114,0	5,0	10,0	2,5	3,0	5,200	3FC
32021A	143,0	150,0	154,0	115,0	116,0	6,0	9,0	2,0	2,5	2,500	4DC
33021A	145,0	150,0	153,0	115,0	116,0	7,0	9,0	2,0	2,5	3,060	2DE
30221A	165,0	178,0	177,0	117,0	122,0	6,0	9,0	2,5	3,0	4,500	3FB
32221A	161,0	178,0	180,0	117,0	120,0	5,0	10,0	2,5	3,0	6,250	3FC
32022A	152,0	160,0	163,0	120,0	122,0	7,0	9,0	2,0	2,5	3,100	4DC
33022A	152,0	160,0	161,0	120,0	123,0	7,0	10,0	2,0	2,5	3,800	2DE
30222A	174,0	188,0	187,0	122,0	129,0	6,0	9,0	2,5	3,0	5,230	3FB
32222A	170,0	188,0	190,0	122,0	126,0	6,0	10,0	2,5	3,0	7,352	3FC
T4CB120	154,0	157,0	164,0	132,0	130,0	4,3	7,5	3,0	3,0	1,540	4CB
32024A	161,0	170,0	173,0	130,0	131,0	7,0	9,0	2,0	2,5	3,183	4DC
33024A	160,0	170,0	171,0	130,0	132,0	6,0	10,0	2,0	2,5	4,140	2DE
30224A	187,0	203,0	201,0	132,0	140,0	6,0	9,5	2,5	3,0	6,270	4FB
32224A	181,0	203,0	204,0	132,0	136,0	7,0	11,5	2,5	3,0	9,270	4FD
T4CB130	171,0	171,0	179,0	144,0	141,0	6,2	8,0	3,0	3,0	2,300	4CB
32026A	178,0	190,0	192,0	140,0	144,0	8,0	11,0	2,0	2,5	5,060	4EC
30226A	203,0	216,0	217,0	144,0	152,0	7,0	9,5	3,0	4,0	7,070	4FB
32226A	193,0	216,0	219,0	144,0	146,0	7,0	13,5	3,0	4,0	11,500	4FD



Tapered roller bearings (continued)

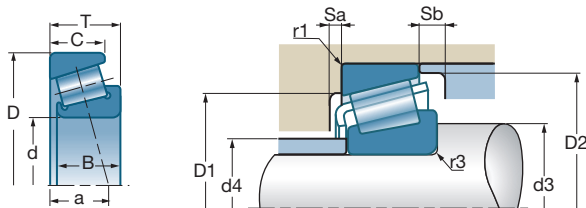



d		D	B	C	T	a			e	Y	Yo		
												10 ³ N	10 ³ N
mm	Ref.	mm	mm	mm	mm	mm	C	C ₀					
140	T4CB140	195	27	21,0	29,00	40,00	204,0	340,0	0,50	1,19	0,66	1700	2300
	32028A	210	45	34,0	45,00	46,00	330,0	580,0	0,46	1,31	0,72	1600	2100
	30228A	250	42	36,0	45,75	47,00	440,0	580,0	0,44	1,38	0,76	1400	2000
	32228A	250	68	58,0	71,75	61,00	610,0	920,0	0,44	1,38	0,76	1400	1900
150	32030A	225	48	36,0	48,00	49,00	370,0	640,0	0,46	1,31	0,72	1400	2000
	30230A	270	45	38,0	49,00	51,50	450,0	605,0	0,44	1,38	0,76	1300	1700
	32230A	270	73	60,0	77,00	64,50	700,0	1070,0	0,44	1,38	0,76	1300	1700
160	T4DB160	220	30	23,0	32,00	44,80	237,0	390,0	0,49	1,23	0,68	1500	2000
	32032A	240	51	38,0	51,00	52,50	435,0	790,0	0,46	1,31	0,72	1400	1800
	32232A	290	80	67,0	84,00	70,00	890,0	1420,0	0,44	1,38	0,76	1200	1600
170	32034A	260	57	43,0	57,00	56,00	500,0	895,0	0,44	1,35	0,74	1300	1700
	32234A	310	86	71,0	91,00	75,00	1000,0	1600,0	0,44	1,38	0,76	1100	1500
180	32036A	280	64	48,0	64,00	59,50	713,5	1170,0	0,42	1,42	0,78	1200	1600
	32236A	320	86	71,0	91,00	77,50	1030,0	1690,0	0,45	1,33	0,73	1100	1400
190	32038A	290	64	48,0	64,00	62,50	655,0	1210,0	0,44	1,36	0,75	1100	1500
200	32940A	280	51	39,0	51,00	54,00	525,0	960,0	0,39	1,52	0,84	1100	1600
	32040A	310	70	53,0	70,00	67,00	750,0	1350,0	0,43	1,39	0,77	1000	1400
240	32048A	360	76	57,0	76,00	78,00	1028,8	1760,0	0,46	1,31	0,72	870	1200
280	32056A	420	87	65,0	87,00	90,50	1250,0	2350,0	0,46	1,31	0,72	700	1000
320	32064A	480	100	74,0	100,00	104,00	1520,0	2940,0	0,46	1,31	0,72	630	840

* These are the speed limits according to the SNR concept (see pages 85 to 87).

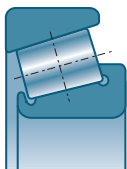
■ Single-row tapered roller bearings (mm) (continued)







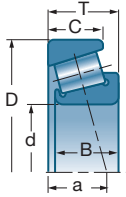

	D1 min	D1 max	D2 min	d3 min	d4 max	Sa min	Sb min	r1 max	r3 max		ISO
Ref.	mm	mm	mm	mm	mm	mm	mm	mm	mm	kg	
T4CB140	180,0	181,0	189,0	152,0	151,0	5,0	8,0	3,0	3,0	2,400	4CB
32028A	187,0	200,0	202,0	150,0	153,0	8,0	11,0	2,0	2,5	5,200	4DC
30228A	219,0	236,0	234,0	154,0	163,0	9,0	9,5	3,0	4,0	9,000	4FB
32228A	210,0	236,0	238,0	154,0	159,0	8,0	13,5	3,0	4,0	14,200	4FD
32030A	200,0	213,0	216,0	162,0	164,0	8,0	12,0	2,5	3,0	6,310	4EC
30230A	234,0	256,0	250,0	164,0	175,0	9,0	11,0	3,0	4,0	11,100	4GB
32230A	226,0	256,0	254,0	164,0	171,0	8,0	17,0	3,0	4,0	18,500	4GD
T4DB160	204,0	206,0	213,0	172,0	172,0	6,0	9,0	3,0	3,0	3,200	4DB
32032A	213,0	228,0	231,0	172,0	175,0	8,0	13,0	2,5	3,0	7,700	4EC
32232A	242,0	276,0	274,0	174,0	183,0	10,0	17,0	3,0	4,0	22,500	4GD
32034A	230,0	248,0	249,0	182,0	187,0	10,0	14,0	2,5	3,0	10,300	4EC
32234A	259,0	292,0	294,0	188,0	196,0	10,0	20,0	4,0	5,0	29,300	4GD
32036A	247,0	268,0	267,0	192,0	199,0	10,0	16,0	2,5	3,0	14,200	3FD
32236A	267,0	302,0	303,0	198,0	204,0	10,0	20,0	4,0	5,0	30,700	4GD
32038A	257,0	278,0	279,0	202,0	209,0	10,0	16,0	2,5	3,0	14,800	4FD
32940A	257,0	268,0	271,0	212,0	216,0	9,0	12,0	2,5	3,0	9,380	
32040A	273,0	298,0	297,0	212,0	221,0	11,0	17,0	2,5	3,0	19,100	4FD
32048A	318,0	346,0	346,0	254,0	261,0	12,0	19,0	3,0	4,0	26,000	4FD
32056A	370,0	402,0	402,0	298,0	305,0	14,0	22,0	4,0	5,0	39,500	4FC
32064A	424,0	462,0	461,0	338,0	350,0	15,0	26,0	4,0	5,0	59,100	4GD



Tapered roller bearings (continued)



■ Single-row tapered roller bearings (inch)

d		D	B	C	T	a					
inch	Ref.	mm	mm	mm	mm	mm	10°N	10°N	rpm*	rpm*	kg
75,987	HM215249/210	131,975	39,000	32,000	39,00	29,00	205,0	285,0	2500	3500	2,190
89,974	HM218248/210	146,975	40,000	32,500	40,00	31,40	251,1	340,0	2400	3200	2,550
88,900	HM518445/410	152,400	39,688	30,163	39,688	33,70	278,8	365,0	2300	3100	2,900
100,000	JHM720249/210	160,000	40,000	32,000	41,00	38,60	260,0	370,0	2200	2900	3,050
50,000	JLM104945N910Z	82,000	27,700	17,000	21,50	22,20	72,0	95,0	4000	5700	0,444
38,000	JL69349/310A	63,000	17,000	13,500	17,00	14,00	41,5	56,0	5300	7500	0,200
80,000	JM515649/610	130,000	34,000	28,500	35,00	30,10	183,6	249,0	2700	3600	1,730
17,462	LM11749/710	39,878	14,605	10,668	13,843	8,80	22,3	22,8	9800	13000	0,085
19,050	LM11949/910	45,237	16,637	12,065	15,494	9,90	29,0	30,3	8400	11000	0,121
21,986	LM12749/710	45,237	16,637	12,065	15,494	10,20	27,8	33,4	8200	10000	0,117
21,986	LM12749/711	45,974	16,637	12,065	15,494	10,20	27,8	33,4	8200	10000	0,122
38,100	LM29749/710	65,088	18,288	13,970	18,034	13,70	43,3	56,8	5200	7300	0,231
34,925	LM48548/510	65,088	18,288	13,970	18,034	13,70	45,7	58,0	5400	7600	0,251
41,275	LM501349/310	73,431	19,812	14,732	19,558	16,30	56,1	69,5	4700	6600	0,328
45,987	LM503349/310	74,976	18,000	14,000	18,00	15,80	53,1	74,8	4400	6200	0,297
45,987	LM503349A/310	74,976	18,000	14,000	18,00	15,80	53,1	74,8	4400	6200	0,297
45,242	LM603049/011	77,788	19,842	15,08	19,842	17,60	57,5	73,5	4400	6100	0,355
31,750	LM67048/010	59,131	16,764	11,811	15,875	12,80	35,3	42,5	5900	8400	0,177
26,988	L44649/610	50,292	14,732	10,668	14,224	10,90	26,7	32,5	6900	9800	0,119
29,000	L45449/410	50,292	14,732	10,668	14,224	10,90	30,0	37,8	7100	9600	0,109
196,850	L540049/010	254,00	27,783	21,433	28,275	42,60	198,0	413,0	1200	1600	3,500
34,988	L68149/110	59,131	16,764	11,938	15,875	13,30	33,3	44,4	5900	7800	0,167

* These are the speed limits according to the SNR concept (see pages 85 to 87).

Double-row spherical roller bearings

Double-row spherical roller bearings	334
■ Definition and capabilities	334
■ Series	335
■ Variants	335
■ Tolerances and clearances	338
■ Design criteria	343
■ Installation/assembly criteria	343
■ Suffixes	343
■ Characteristics	344
<i>Spherical double-row rollers with cylindrical bore</i>	344
<i>Spherical double-row rollers with tapered bore and adapter sleeves</i>	354
<i>Spherical double-row rollers with tapered bore and withdrawal sleeves</i>	362
<i>Spherical double-row rollers with tapered bore for high vibration applications</i>	373



Double-row spherical roller bearings

Definition and capabilities

→ Definition

The outer ring of this type of bearing has a spherical raceway that allows angular movement of the rings. This means that the bearing can accept high degrees of misalignment.

Its internal design enables it to withstand very high radial loads and axial loads. Variants with a tapered bore allow fitting using an adapter sleeve.

This type of bearing is particularly suited to heavy mechanical applications where it is difficult to align the seats and radial loads are high. It is well suited to severe operating conditions, involving impact or vibration (crushers, vibrating screens, heavy handling machinery, etc.).



Premier: SNR high performance standard

Started with spherical roller bearings, the « Premier » approach consists of developing standardised bearings with high-level performance, endurance and longevity features as a standard.

Symbol of the quality of our brand as a standard product, « Premier » creates a strong identity and demonstrates the desire of SNR to offer consistent value for the most common applications.

■ The 4 keys of the Premier approach

To become « Premier », our standard bearings must meet strict requirements in 4 fields which determine their reliability and their life:

- ▶ **A thorough control of steel:** less wear, less damage, more stability at high temperature.
- ▶ **Design:** compactness and load capacity, the result of SNR experience.
- ▶ **Sealing lubrication:** important elements in the design.
- ▶ **Bearing finish:** quality assurance in production and continuous improvement activity on machines and processes.

■ Spherical roller bearings: first Premier

SNR spherical roller bearings were the first to benefit from the Premier system. The tests carried out on these new products showed very significant gains: **+18%** for the load capacity, **+75%** minimum life duration. The « Premier » brand name is clearly visible on the specific packaging created for the launching of the range. The bearing itself bears a specific marking. In addition, to fight against counterfeits, all SNR standard bearings benefit from a new holographic label comprising several safety levels. These multiple identifications express the difference between SNR « standard » and products without any guarantee. Gradually, the Premier specification will be applied to all the brand's bearings.

→ Capabilities

■ Loads and speeds

The internal design of double-row spherical roller bearings demands good lubrication to achieve the high performance levels specific to this type of bearing.

■ Misalignment

These bearings accept misalignment angles of about 0.5° without reducing their loading capacity. This angle must nevertheless be limited in order to remain within values compatible with the sealing system used.

Series

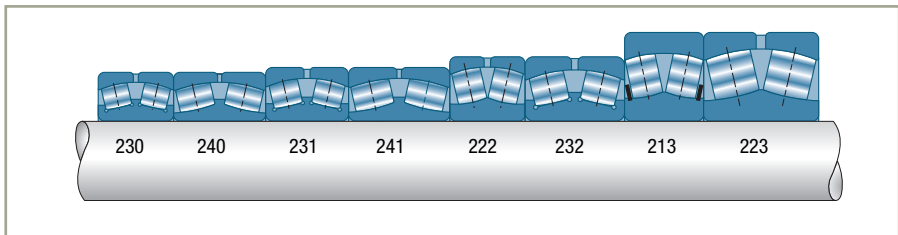

Variants

■ Bearings with tapered bore.

Taper:

- 1:12 for all series (suffix K)
- except series 240 and 241 (taper 1:30, suffix K30)

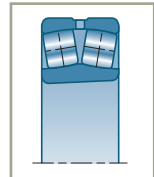

This bearing can be mounted:

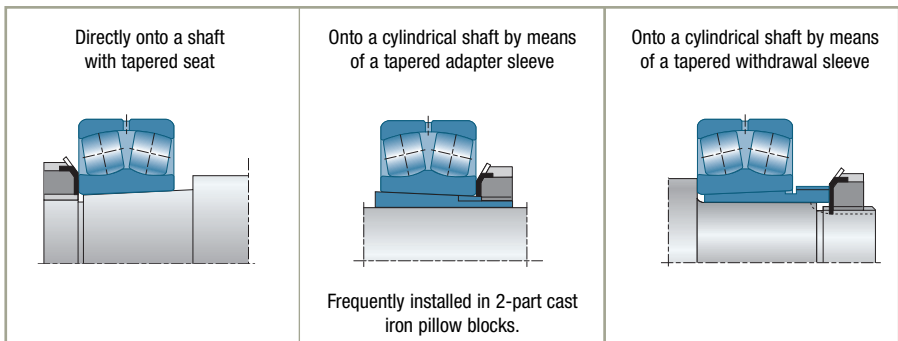

Double-row spherical roller bearings *(continued)*

■ Groove and lubrication holes in the outer ring. Suffix W33

Standard manufacture double-row spherical bearings, with the exception of series 213, have a groove and three lubrication holes on the outer ring to allow lubrication. The dimensions of the groove are indicated in the "List of Standard Bearings".

These bearings can be supplied on request without the groove and lubrication holes.

■ Cages

► Steel sheet cage: SNR PREMIER EA series

General and extreme temperature applications.

This bearing is designed for all general applications and more particularly when the operating temperature exceeds 150°C (302°F).

- **Resistance to high and low temperatures:** from -60 to +200°C (140°F to 392° F), thanks to the bearing ring dimensional stabilization heat treatment, complemented by a suitable lubricant.
- **Accurate cage centering**, on the ground surface of the inner ring's bearing race and on the large rolling elements, resulting in more precise roller guidance.
- **Precise guidance of the rollers** retained by the pockets, each comprising 4 retaining tabs with a controlled chamfer, for perfect positioning of the rolling elements without added components. This guarantees minimized friction and overheating, for an increased service life, with reduced maintenance.
- **The surface treatment** (phosphatizing – oiling) reduces the friction coefficient and the wear, for higher resistance at high speed.
- **Excellent lubrication** due to the shape of the cage which increases the lubricant reserves in the bearing and facilitates its flow.

The series 24000 is a very wide series, with extra-long rollers ensuring optimized capacity. Therefore, SNR decided to maintain the lateral shoulders and the central rib.

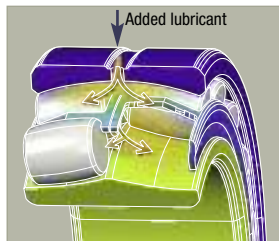
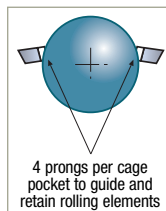
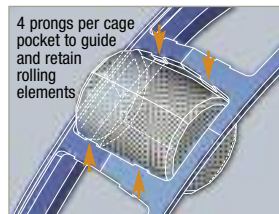

► **Solid copper alloy cage (brass) : SNR PREMIER EM series**

Demanding applications.

This bearing provides a solution for temperatures up to 200°C (392°F), with tough operating conditions (high speeds, shock loads, contamination).

- **Minimized resonance** due to the one-piece cage.
- **Resistance to shocks and highest rigidity** due to the plastic deformation capacity of the material (copper alloy-brass).
- **Friction reduction:**
 - The self-lubricating properties of the cage material, reducing friction at high speed.
 - The cage centered on the rolling elements, with lateral shoulder sections on the inner ring. The absence of a cage / ring contact prevents any component from siezing in case of thermal expansion.
- **Perfect roller radial guidance** and good roller / cage load distribution, by the pockets surrounding the rolling elements.

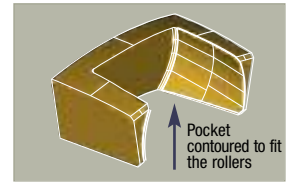
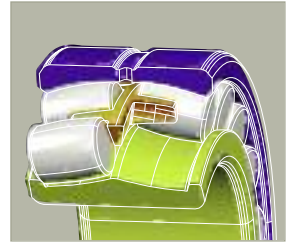

► **Polyamide 6.6 nylon cage, filled with 25% glass fiber: SNR PREMIER EG15 series**

Average temperature applications.

This bearing is designed for all general applications when temperature does not exceed +150°C (302°F).

- **Very good strength** thanks to the material, providing flexibility and elasticity, as well as dual design: each row of rollers is guided by its own cage.
- **Very good roller guidance** thanks to its « window style » design, obtained from a specific cast process, guaranteeing high reliability.
- **Good lubrication** improved by the cage design: apertures in the external shroud, low polyamide / steel friction coefficient. This cage ensures good distribution of the lubrication film.
- **Low noise level** thanks to the material used.
- **Good corrosion resistance:** no alteration of the cage in case of accidental presence of water.

Non-conductive and resistant to many chemical or electrochemical agents.

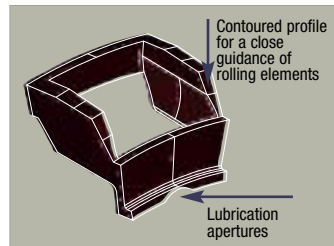
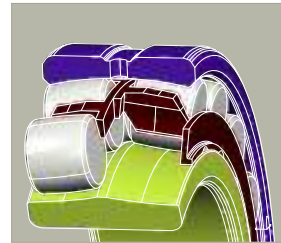

Double-row spherical roller bearings (continued)

- Solid copper alloy cage (brass), reduced internal tolerance & clearance ranges:
SNR PREMIER EF800 series

High vibration applications.

The vibratory mechanisms such as those found in shaker screens, crushers, grinders or construction equipment engines, are the most demanding applications for spherical roller bearings.

- **Resistance to vibrations** by the solid one-piece machined cage, which minimizes resonance phenomena, and their induced failures.
- **Strengthened roller retention under vibrations** thanks to the lateral shoulders in the inner ring and to the internal clearance control at installation. To ensure correct operation in vibration applications, the tolerances on the outer diameter, the bore and the internal clearance are reduced.
- **Special radial clearance:** C4, utilizing the upper 2/3 of the C4 tolerance range, in order to perfectly control the internal clearance after installation. This type of special tolerance is also available in classes C and C3.

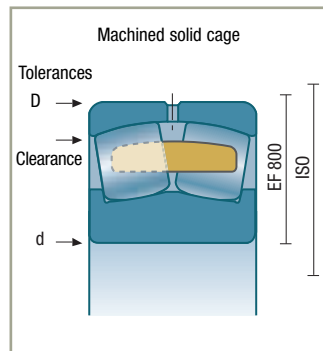

Tolerances and clearances

→ Tolerances

These bearings are supplied in normal precision standards (ISO 492 Standard). The F800 series have special tolerances on the outer diameter and bore adapted to vibrating applications to secure their interchangeability. SNR can supply bearings with reduced tolerances on one or more characteristics (bore, outside diameter, precision of rotation, inner ring, etc.).

→ Internal radial clearance

The radial clearance is defined by ISO 5753 Standard. The values are different for bearings with a tapered bore due to the reduction of the internal clearance when fitting them on their seat.

Approximate recommended residual clearance J_{rm} after fitting:

$$J_{rm} = 5 d^{1/2} 10^{-3}$$

■ Spherical double-row rollers with cylindrical bore



Series 213-222-223-230-231-232-240-241

Bore diameter d (mm)	Group 2		Group N		Group 3		Group 4		Group 5	
	min	max	min	max	min	max	min	max	min	max
14 <d≤ 18	10	20	20	35	35	45	45	60	60	75
18 <d≤ 24	10	20	20	35	35	45	45	60	60	75
24 <d≤ 30	15	25	25	40	40	55	55	75	75	95
30 <d≤ 40	15	30	30	45	45	60	60	80	80	100
40 <d≤ 50	20	35	35	55	55	75	75	100	100	125
50 <d≤ 65	20	40	40	65	65	90	90	120	120	150
65 <d≤ 80	30	50	50	80	80	110	110	145	145	180
80 <d≤ 100	35	60	60	100	100	135	135	180	180	225
100 <d≤ 120	40	75	75	120	120	160	160	210	210	260
120 <d≤ 140	50	95	95	145	145	190	190	240	240	300
140 <d≤ 160	60	110	110	170	170	220	220	280	280	350
160 <d≤ 180	65	120	120	180	180	240	240	310	310	390
180 <d≤ 200	70	130	130	200	200	260	260	340	340	430
200 <d≤ 225	80	140	140	220	220	290	290	380	385	470
225 <d≤ 250	90	150	150	240	240	320	320	420	420	520
250 <d≤ 280	100	170	170	260	260	350	350	460	460	570
280 <d≤ 315	110	190	190	280	280	370	370	500	500	630
315 <d≤ 355	120	200	200	310	310	410	410	550	550	690
355 <d≤ 400	130	220	220	340	340	450	450	600	600	750
400 <d≤ 450	140	240	240	370	370	500	500	660	660	820
450 <d≤ 500	140	260	260	410	410	550	550	720	720	900
500 <d≤ 560	150	280	280	440	440	600	600	780	780	1000
560 <d≤ 630	170	310	310	480	480	650	650	850	850	1100
630 <d≤ 710	190	350	350	530	530	700	700	920	925	1190

Value in μm



Double-row spherical roller bearings (continued)

■ Spherical double-row rollers with tapered bore



Series 213K-222K-223K-230K-231K-232K-240K-241K

Bore diameter d (mm)	Group 2		Group N		Group 3		Group 4		Group 5	
	min	max	min	max	min	max	min	max	min	max
18 <d≤ 24	15	25	25	35	35	45	45	60	60	75
24 <d≤ 30	20	30	30	40	40	55	55	75	75	95
30 <d≤ 40	25	35	35	50	50	65	65	85	85	105
40 <d≤ 50	30	45	45	60	60	80	80	100	100	130
50 <d≤ 65	40	55	55	75	75	95	95	120	120	160
65 <d≤ 80	50	70	70	95	95	120	120	150	150	200
80 <d≤ 100	55	80	80	110	110	140	140	180	180	230
100 <d≤ 120	65	100	100	135	135	170	170	220	220	280
120 <d≤ 140	80	120	120	160	160	200	200	260	260	330
140 <d≤ 160	90	130	130	1870	180	230	230	300	300	380
160 <d≤ 180	100	140	140	200	200	260	260	340	340	430
180 <d≤ 200	110	160	160	220	220	290	290	370	370	470
200 <d≤ 225	120	180	180	250	250	320	320	410	410	520
225 <d≤ 250	140	200	200	270	270	350	350	450	450	570
250 <d≤ 280	150	220	220	300	300	390	390	490	490	620
280 <d≤ 315	170	240	240	330	330	430	430	540	540	680
315 <d≤ 355	190	270	270	360	360	470	470	590	590	740
355 <d≤ 400	210	300	300	400	400	520	520	650	650	820
400 <d≤ 450	230	330	330	440	440	570	570	720	720	910
450 <d≤ 500	260	370	370	490	490	630	630	790	790	1000
500 <d≤ 560	290	410	410	540	540	680	680	870	870	1100
560 <d≤ 630	320	460	460	600	600	760	760	980	980	1230
630 <d≤ 710	350	510	510	670	670	850	850	1090	1090	1360

Value in μm

■ Axial clearance

As the axial clearance J_a depends on the radial clearance J_r it can be approximated using the following formula:

$$J_a = 2,27 Y_0 \cdot J_r$$

■ Control of fitting and clearance

During the fitting of the bearing on the sleeve the inner ring is expanded reducing the internal radial clearance of the bearing.

This clearance reduction allows one to estimate the fit. It is most important to monitor this characteristic to ensure that the final clearance is adequate to allow proper bearing operation.

► Double-row self-aligning ball bearings

Swivel the bearing outer ring by hand. The rotation must be smooth and oscillation easy.

► Spherical roller bearings

• Principle of measurement

The clearance is measured by sliding a feeler gauge between the outer ring and the rollers. With large bearings do not use feeler gauges over 0.150 mm thick since they are too stiff to take the curve of the outer ring raceway. Stack up a combination of thinner gauges instead.

• Practical measurement

Place the bearing upright, the rings must be parallel. Manually rotate the inner ring to ensure that the rollers are properly seated. Find in the column 2 of the table below, the minimum value of the standardized clearance that corresponds to the bore and clearance class of the bearing. Choose a feeler gauge slightly smaller than this value.

Slide the gauge at an angle between the unloaded rollers and the outer ring race.

Progressively increase the gauge thickness. The clearance value will be situated between the last « pass » gauge and the next one that failed to « pass ».

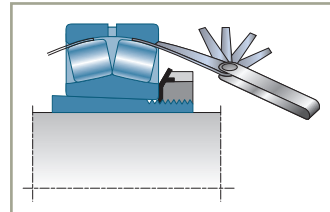

► Monitoring of fitting and clearance

• Radially

Drive up the bearing until the clearance has been reduced to the indicated limits. Check that the final residual clearance is no smaller than the value stated for the particular clearance class (column 3)

• Axially (shaft with tapered seat)

The axial movement corresponding to the tightening must be within the indicated limits (column 4). Check that the final residual clearance is no smaller than the value stated for the particular clearance class.

Double-row spherical roller bearings (continued)

■ Measurement of radial clearance during fitting

Bearing bore (mm)		Prior to mounting (2)						After mounting (3)						Axial drive-up			
		C0		C3		C4		C0		C3		C4		mm			
		According ISO 5753 (in mm)		According ISO 5753 (in mm)		According ISO 5753 (in mm)		Feeler gauge*		Feeler gauge*		Feeler gauge*		Taper 1:12		Taper 1:30	
from	including	Mini	Maxi	Mini	Maxi	Mini	Maxi	yes	no	yes	no	yes	no	Mini	Maxi	Mini	Maxi
30	40	0.035	0.050	0.050	0.065	0.065	0.085	2	3	3	4	4	5	0.350	0.400	-	-
40	50	0.045	0.060	0.060	0.080	0.080	0.100	3	4	3	5	4	6	0.400	0.450	-	-
50	65	0.055	0.075	0.075	0.095	0.095	0.120	3	5	4	6	5	7	0.450	0.600	-	-
65	80	0.070	0.095	0.095	0.120	0.120	0.150	4	6	5	7	6	8	0.600	0.750	-	-
80	100	0.080	0.110	0.110	0.140	0.140	0.180	4	6	6	8	7	10	0.700	0.900	1.700	2.200
100	120	0.100	0.135	0.135	0.170	0.170	0.220	5	7	7	9	9	12	0.750	1.100	1.900	2.700
120	140	0.120	0.160	0.160	0.200	0.200	0.260	8	11	10	13	12	17	1.100	1.400	2.700	3.500
140	160	0.130	0.180	0.180	0.230	0.230	0.300	8	12	11	15	14	19	1.200	1.600	3.000	4.000
160	180	0.140	0.200	0.200	0.260	0.260	0.340	9	13	12	17	16	21	1.300	1.700	3.200	4.200
180	200	0.160	0.220	0.220	0.290	0.290	0.370	11	16	15	20	20	26	1.400	2.000	3.500	5.000
200	225	0.180	0.250	0.250	0.320	0.320	0.410	12	17	17	22	22	28	1.600	2.200	4.000	5.500
225	250	0.200	0.270	0.270	0.350	0.350	0.450	14	19	18	24	24	31	1.700	2.400	4.200	6.700
250	280	0.220	0.300	0.300	0.390	0.390	0.490	15	21	20	27	26	33	1.900	2.700	4.700	6.700
280	315	0.240	0.330	0.330	0.430	0.430	0.540	16	23	22	29	29	37	2.000	3.000	5.000	7.500
315	355	0.270	0.360	0.360	0.470	0.470	0.590	18	25	24	32	32	40	2.400	3.300	6.000	8.200
355	400	0.300	0.400	0.400	0.520	0.520	0.650	20	27	27	36	35	44	2.600	3.600	6.500	9.000
400	450	0.330	0.440	0.440	0.570	0.570	0.720	22	30	29	39	38	49	3.100	4.000	7.700	10.000
450	500	0.370	0.490	0.490	0.630	0.630	0.790	25	33	33	43	42	54	3.300	4.400	8.200	11.000
500	600	0.410	0.540	0.540	0.680	0.680	0.870	28	37	36	46	46	59	3.700	5.000	9.200	12.500

* Practical measurement of clearance to within 1/100th of an mm by means thickness shims. For values smaller than 4/100th of an mm, use peel shims.

Design criteria

■ Bearing life

■ Axial load

Double-row spherical roller bearings can withstand axial loads.

It is nevertheless recommended not to exceed a value of $F_a / F_r = 0,6$

Installation/assembly criteria

The residual clearance of the bearing must be checked after fitting. This check is vital for bearings with a tapered bore.

Relation between the axial displacement (a) of a tapered bore bearing and the corresponding reduction in its radial clearance ΔJ_r :

ΔJ_r :

taper 1:12

$$a = 12 \Delta J_r / t_i$$

taper 1:30

$$a = 30 \Delta J_r / t_i$$

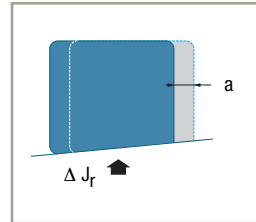

a (axial displacement)

ΔJ_r : reduction in radial clearance

t_i : repercussion factor for the interference fit of the inner ring:

$t_i = 0.75$ if the bearing is mounted directly on a tapered seat of a solid shaft

$t_i = 0.7$ if the bearing is mounted on a tapered adapter sleeve

Suffixes

C2	ISO radial clearance category 2
C3	ISO radial clearance category 3
C4	ISO radial clearance category 4
C5	ISO radial clearance category 5
EA	Bearing of the range "Premier" with pressed steel cage
EG15	Bearing of the range "Premier" with polyamide 6/6 cage
EM	Bearing of the range "Premier" with Machined brass cage
EF800	Bearing of the range "Premier" for vibrations applications
K	Tapered bore, 1:12 taper
K30	Tapered bore, 1:30 taper
V	Internal design index
W33	Groove and lubrication holes in outer ring

Double-row spherical roller bearings (continued)

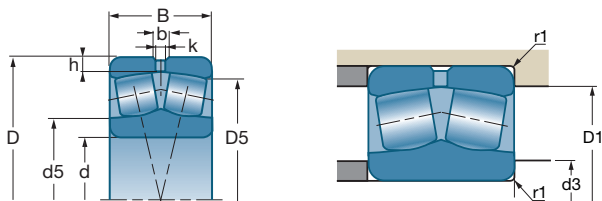

d		D	B	b	k	h			e
							10°N	10°N	
mm	References	mm	mm	mm	mm	mm	10°N	10°N	
25	* 22205 E 21305 V	52	18	3	1.5	2.8	54.4	46.1	0.34
		62	17			3.5	48.5	37.5	0.29
30	* 22206 E 21306 V	62	20	4.4	2	2.8	72	64.5	0.31
		72	19			3.5	63	50	0.28
35	* 22207 E 21307 V	72	23	4.9	2	3.5	95.4	92	0.31
		80	21			4.5	79	66	0.27
40	* 22208 E 21308 V * 22308 E	80	23	5.4	2.5	3.5	110	105	0.27
		90	23			4.5	96	84	0.26
		90	33	5.9	3	4.5	161	152	0.36
45	* 22209 E 21309 V * 22309 E	85	23	5.8	2.5	3.5	115	113	0.26
		100	25			4.5	119	106	0.26
		100	36	6.4	3	4.5	196	187	0.36
50	* 22210 E 21310 V * 22310 E	90	23	5.8	2.5	3.5	124	124	0.24
		110	27			5.5	137	128	0.25
		110	40	7.4	3.5	5.5	237	232	0.36
55	* 22211 E 21311 V * 22311 E	100	25	6.3	3	4.5	147	148	0.23
		120	29			5.5	167	158	0.24
		120	43	7.8	3.5	5.5	282	274	0.36
60	* 22212 E 21312 V * 22312 E	110	28	6.9	3	4.5	178	181	0.24
		130	31			6	186	179	0.24
		130	46	8.7	4	6	323	319	0.35
65	* 22213 E 21313 V * 22313 E	120	31	7.8	3.5	4.5	215	224	0.24
		140	33			6	224	215	0.23
		140	48	9.2	4	6	351	343	0.33
70	* 22214 E 21314 V * 22314 E	125	31	7.4	3.5	4.5	224	240	0.22
		150	35			6	246	240	0.23
		150	51	10.4	5	6	400	396	0.34
75	* 22215 E 21315 V * 22315 E	130	31	7.4	3.5	4.5	232	249	0.22
		160	37			6	280	275	0.23
		160	55	10.3	5	6	467	467	0.34
80	* 22216 E 21316 V * 22316 E	140	33	7.9	3.5	5.5	265	287	0.22
		170	39			6	305	305	0.23
		170	58	10.4	5	6	515	522	0.34

* indicate bearings of the range SNR PREMIER

Characteristics

■ Spherical double-row rollers with cylindrical bore



References	Y		Yo	rpm**	rpm**	d5 ≈	d3 min	D1 max	D5 ≈	r1 max	kg
	Fa ≤ e Fr	Fa > e Fr									
* 22205 E 21305 V	2 2.33	2.98 3.47	1.96 2.28	8600 6800	11000 9100	30 34	30 32	47 55	46 52	1 1.1	0.170 0.257
* 22206 E 21306 V	2.15 2.45	3.2 3.64	2.1 2.39	7200 5800	9300 7700	37 40	36 37	57 65	55 60	1 1.1	0.272 0.394
* 22207 E 21307 V	2.21 2.48	3.29 3.69	2.16 2.42	6100 5200	7900 6900	45 46	42 44	66 71	63 68	1.1 1.5	0.440 0.513
* 22208 E 21308 V	2.47 2.55	3.67 3.8	2.41 2.5	5500 4500	7100 6100	50 53	47 49	74 81	71 76	1.1 1.5	0.515 0.715
* 22308 E	1.87	2.79	1.83	4100	5300	52	49	83	78	1.5	1.006
* 22209 E 21309 V	2.64 2.64	3.93 3.93	2.58 2.58	5100 4100	6600 5400	54 59	52 54	79 91	76 85	1.1 1.5	0.565 0.949
* 22309 E	1.9	2.83	1.86	3700	4800	58	54	93	87	1.5	1.352
* 22210 E 21310 V	2.84 2.71	4.23 4.04	2.78 2.65	4800 3700	6200 4900	59 66	57 61	84 99	81 93	1.1 2	0.603 1.251
* 22310 E	1.87	2.79	1.83	3400	4400	63	61	101	95	2	1.810
* 22211 E 21311 V	2.95 2.82	4.4 4.2	2.89 2.76	4300 3300	5500 4500	66 73	64 66	93 109	90 102	1.5 2	0.823 1.537
* 22311 E	1.87	2.79	1.83	3100	4000	68	66	111	104	2	2.290
* 22212 E 21312 V	2.84 2.81	4.23 4.19	2.78 2.75	3900 3100	5100 4100	71 79	69 72	103 118	99 110	1.5 2.1	1.134 1.986
* 22312 E	1.95	2.9	1.91	2900	3700	75	72	120	113	2.1	2.804
* 22213 E 21313 V	2.79 2.91	4.15 4.33	2.73 2.84	3600 2900	4700 3800	78 85	74 77	113 128	107 120	1.5 2.1	1.512 2.410
* 22313 E	2.06	3.06	2.01	2700	3400	81	77	130	122	2.1	3.413
* 22214 E 21314 V	3.01 2.9	4.48 4.31	2.94 2.83	3400 2700	4400 3600	84 91	79 82	118 138	113 127	1.5 2.1	1.586 2.990
* 22314 E	2	2.98	1.96	2500	3200	85	82	140	131	2.1	4.176
* 22215 E 21315 V	3.14 2.94	4.67 4.37	3.07 2.87	3200 2500	4200 3400	88 97	84 87	123 148	118 137	1.5 2.1	1.644 3.590
* 22315 E	2	2.98	1.96	2300	3000	91	87	150	139	2.1	5.083
* 22216 E 21316 V	3.14 2.95	4.67 4.4	3.07 2.89	3000 2400	3900 3200	94 104	91 92	131 158	127 145	2 2.1	2.071 4.260
* 22316 E	2	2.98	1.96	2200	2800	98	92	160	148	2.1	6.030

** These are the speed limits according to the SNR concept (see pages 85 to 87).



Double-row spherical roller bearings (continued)

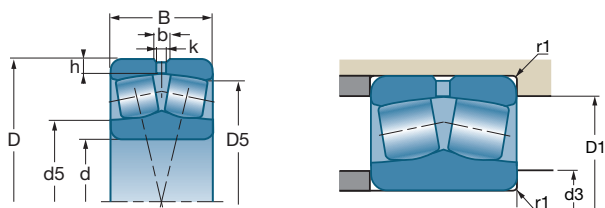



d		D	B	b	k	h			e
							10°N	10°N	
mm	References	mm	mm	mm	mm	mm			
85	* 22217 E	150	36	7.9	3.5	5.5	308	330	0.22
	* 21317 V	180	41			7	355	365	0.23
	* 22317 E	180	60	11	5	7	570	604	0.32
90	* 22218 E	160	40	10.2	4.5	5.5	366	398	0.23
	* 23218 E	160	52.4	8.86	4	5.5	445	513	0.3
	* 21318 V	190	43			7	385	400	0.23
	* 22318 E	190	64	11.56	5	7	636	652	0.33
95	* 22219 E	170	43	9.93	4.5	6	395	417	0.23
	* 22319 E	200	67	12.15	6	7	696	751	0.32
100	* 24020 E	150	50	6.4	3.5	3.5	325	425	0.3
	* 23120 E	165	52	8.4	4	5.5	448	575	0.28
	* 22220 E	180	46	11.2	5	6	449	495	0.24
	* 23220 E	180	60.3	9.44	6	6	558	661	0.31
	* 22320 E	215	73	13.3	6	7	787	844	0.34
110	* 23022 E	170	45	7.83	3.5	4.4	397	517	0.23
	* 24022 E	170	60	6.8	3.5	4.4	465	615	0.33
	* 23122 E	180	56	8.86	4	5.5	521	669	0.28
	* 24122 E	180	69	8.4	4	5.5	530	675	0.36
	* 22222 E	200	53	12.2	6	6	573	643	0.25
	* 23222 E	200	69.8	10.52	5	6	716	869	0.32
	* 22322 E	240	80	15.6	7	7	928	972	0.31
120	* 23024 E	180	46	7.83	3.5	4.4	424	577	0.22
	* 24024 E	180	60	7.34	3.5	4.4	465	640	0.3
	* 23124 E	200	62	10.04	4.5	5.5	630	820	0.28
	* 24124 E	200	80	10.05	4.5	5.5	695	925	0.39
	* 22224 E	215	58	12.16	6	6	654	753	0.25
	* 23224 E	215	76	11	5	6	815	998	0.32
	* 22324 E	260	86	18	8	7	1110	1280	0.32
130	* 23026 E	200	52	8.91	4	4.4	538	721	0.22
	* 24026 E	200	69	8.4	4	4.4	590	795	0.32
	* 23126 E	210	64	10.04	4.5	5.5	675	906	0.27
	* 24126 E	210	80	9.48	4.5	5.5	720	965	0.35
	* 22226 E	230	64	13.21	6	7	768	898	0.25
	* 23226 E	230	80	11.56	5	7	912	1130	0.32
	* 22326 E	280	93	18.9	9	8.5	1260	1400	0.33

* indicate bearings of the range SNR PREMIER

■ Spherical double-row rollers with cylindrical bore (continued)



References	Y		Yo			d5	d3 min	D1 max	D5	r1 max	
	Fa — ≤ e Fr	Fa — > e Fr									
* 22217 E	3.07	4.57	3	2800	3600	100	96	141	137	2	2.560
* 21317 V	2.99	4.46	2.93	2200	3000	111	99	166	154	3	5.230
* 22317 E	2.09	3.11	2.04	2000	2600	107	99	166	157	3	7.061
* 22218 E	2.9	4.31	2.83	2700	3500	105	101	151	144	2	3.283
* 23218 E	2.25	3.34	2.2	2200	2900	104	101	149	141	2	4.430
* 21318 V	3	4.47	2.93	2100	2800	117	104	176	162	3	6.110
* 22318 E	2.06	3.06	2.01	1900	2500	110	104	176	166	3	8.285
* 22219 E	2.95	4.4	2.89	2500	3200	110	107	158	153	2.1	3.950
* 22319 E	2.09	3.11	2.04	1800	2300	120	109	186	174	3	9.890
* 24020 E	2.25	3.34	2.2	1900	2500	108	107	143	136	1.5	2.690
* 23120 E	2.39	3.56	2.34	2200	2900	114	111	154	147	2	4.400
* 22220 E	2.84	4.23	2.78	2400	3100	118	112	170	161	2.1	4.900
* 23220 E	2.18	3.24	2.13	1900	2600	127	114	168	187	2.1	6.380
* 22320 E	1.98	2.94	1.93	1700	2200	127	114	201	187	3	12.470
* 23022 E	2.95	4.4	2.89	2300	3000	123	119	161	155	2	3.550
* 24022 E	2.03	3.02	1.98	1700	2200	122	120	161	152	2	4.960
* 23122 E	2.43	3.61	2.37	2000	2700	125	121	169	161	2	5.480
* 24122 E	1.85	2.76	1.81	1000	1300	121	121	169	158	2	6.850
* 22222 E	2.69	4	2.63	2200	2800	130	122	190	179	2.1	6.929
* 23222 E	2.12	3.15	2.07	1700	2300	130	122	188	176	2.1	9.250
* 22322 E	2.09	3.11	2.04	1600	2000	139	124	226	209	3	16.870
* 23024 E	3.14	4.67	3.07	2200	2900	134	129	171	165	2	3.990
* 24024 E	2.25	3.34	2.2	1700	2100	131	129	171	165	2	5.200
* 23124 E	2.43	3.61	2.37	1800	2400	138	131	189	179	2	7.670
* 24124 E	1.74	2.59	1.7	950	1200	133	131	189	172	2	10.000
* 22224 E	2.74	4.08	2.68	1900	2500	141	132	203	193	2.1	8.693
* 23224 E	2.09	3.11	2.04	1600	2100	139	132	203	190	2.1	11.275
* 22324 E	2.09	3.11	2.04	1400	1800	156	134	246	225	3	22.170
* 23026 E	3.01	4.48	2.94	2000	2600	145	139	191	183	2	5.810
* 24026 E	2.09	3.11	2.04	1500	1900	141	139	191	179	2	7.740
* 23126 E	2.51	3.74	2.45	1700	2300	148	141	199	189	2	8.400
* 24126 E	1.92	2.86	1.88	850	1200	144	141	199	184	2	11.800
* 22226 E	2.69	4	2.63	1800	2400	151	144	216	206	3	10.771
* 23226 E	2.12	3.15	2.07	1500	2000	150	144	216	204	3	13.550
* 22326 E	2.06	3.06	2.01	1300	1700	164	144	263	243	4	26.917

** These are the speed limits according to the SNR concept (see pages 85 to 87).



Double-row spherical roller bearings (continued)

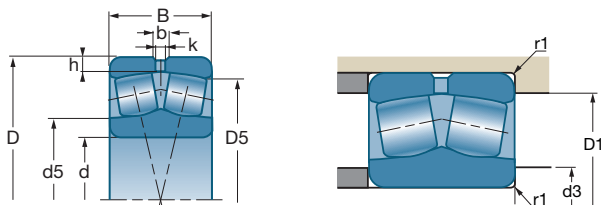

d		D	B	b	k	h			e
							10 ⁶ N	10 ⁶ N	
mm	References	mm	mm	mm	mm	mm	10 ⁶ N	10 ⁶ N	
140	* 23028 E	210	53	8.91	4	4.4	568	783	0.22
	* 24028 E	210	69	9.9	4.5	4.4	625	900	0.31
	* 23128 E	225	68	10.54	5	6	763	1030	0.26
	* 24128 E	225	85	10.7	4.5	6	830	1120	0.36
	* 22228 E	250	68	14.18	7	7	867	1010	0.25
	* 23228 E	250	88	12.6	6	7	1090	1370	0.33
	* 22328 E	300	102	18.9	9	8.5	1470	1720	0.33
150	* 23030 E	225	56	9.96	4.5	5.1	628	893	0.21
	* 24030 E	225	75	9.3	4	5.1	715	1000	0.31
	* 23130 E	250	80	12.63	6	6	1010	1350	0.29
	* 24130 E	250	100	10.4	5	6	1070	1400	0.38
	* 22230 E	270	73	15.33	7	7	1020	1220	0.25
	* 23230 E	270	96	13.7	6	7	1280	1620	0.33
	* 22330 E	320	108	19.9	9	8.5	1660	1890	0.34
160	* 23032 E	240	60	10.52	5	5.1	711	1000	0.21
	* 24032 E	240	80	9.4	4.5	5.1	785	1090	0.3
	* 23132 E	270	86	13.7	6	6	1160	1580	0.29
	* 24132 E	270	109	11.7	5	6	1260	1740	0.38
	* 22232 E	290	80	16.94	8	7	1160	1390	0.25
	* 23232 E	290	104	14.85	7	7	1470	1890	0.33
	* 22332 E	340	114	20.3	10	8.5	1850	2210	0.33
170	* 23034 E	260	67	11.59	5	5.1	869	1240	0.22
	* 24034 E	260	90	10.5	5	5.1	1010	1430	0.32
	* 23134 E	280	88	13.7	6	6	1200	1700	0.28
	* 24134 E	280	109	13.2	6	6	1310	1840	0.37
	* 22234 E	310	86	17.98	8	8.5	1330	1610	0.26
	* 23234 V	310	110	13.9	7.5	8.5	1210	1830	0.32
	* 22334 E	360	120	20.25	10	8.5	2100	2630	0.32
180	* 23036 E	280	74	13.24	6	5.1	1020	1450	0.23
	* 24036 E	280	100	11.7	5	5.1	1170	1700	0.33
	* 23136 E	300	96	14.85	7	7	1420	1960	0.29
	* 24136 E	300	118	14.1	6	7	1470	2050	0.38
	* 22236 E	320	86	18	8	8.5	1380	1660	0.25
	* 23236 V	320	112	13.9	7.5	8.5	1290	2050	0.31
	* 22336 V	380	126	23.1	12	8.5	1580	2190	0.31
190	* 23038 E	290	75	13.24	6	5.1	1080	1570	0.22
	* 24038 E	290	100	11.59	5	5.1	1240	1800	0.31
	* 23138 V	320	104	20	7.5	7	1180	1950	0.29

* indicate bearings of the range SNR PREMIER

■ Spherical double-row rollers with cylindrical bore (continued)



References	Y		Yo			d5	d3 min	D1 max	D5	r1 max	
	Fa — ≤ e Fr	Fa — > e Fr									
				rpm**	rpm**	mm	mm	mm	mm	mm	kg
* 23028 E	3.14	4.67	3.07	1900	2500	155	149	201	193	2	6.330
* 24028 E	2.21	3.29	2.16	1400	1800	153	149	201	189	2	9.090
* 23128 E	2.55	3.8	2.5	1600	2100	159	152	213	203	2.1	10.900
* 24128 E	1.9	2.83	1.86	800	1100	154	152	213	198	2.1	13.000
* 22228 E	2.74	4.08	2.68	1700	2200	163	154	236	224	3	14.200
* 23228 E	2.06	3.06	2.01	1400	1800	162	154	236	220	3	18.400
* 22328 E	2.03	3.02	1.98	1200	1600	181	157	283	261	4	34.130
* 23030 E	3.2	4.77	3.13	1800	2300	167	161	214	207	2.1	7.620
* 24030 E	2.18	3.24	2.13	1300	1600	162	161	215	205	2.1	10.200
* 23130 E	2.35	3.5	2.3	1400	1900	171	162	238	223	2.1	15.720
* 24130 E	1.78	2.65	1.74	850	1100	165	162	240	219	2.1	19.900
* 22230 E	2.74	4.08	2.68	1500	2000	177	164	256	242	3	17.800
* 23230 E	2.03	3.02	1.98	1300	1700	174	164	256	237	2.1	23.520
* 22330 E	2	2.98	1.96	1200	1500	188	167	303	279	4	41.960
* 23032 E	3.2	4.77	3.13	1700	2200	177	172	229	221	2.1	9.150
* 24032 E	2.28	3.39	2.23	1200	1500	173	172	230	217	2.1	12.300
* 23132 E	2.35	3.5	2.3	1300	1800	185	172	258	240	2.1	20.120
* 24132 E	1.76	2.62	1.72	800	1000	180	172	260	236	2.1	25.600
* 22232 E	2.69	4	2.63	1400	1900	190	174	276	260	3	23.000
* 23232 E	2.03	3.02	1.98	1200	1600	186	174	276	259	3	29.580
* 22332 E	2.03	3.02	1.98	1100	1400	205	177	323	296	4	50.700
* 23034 E	3.07	4.57	3	1600	2000	190	181	249	238	2.1	13.000
* 24034 E	2.12	3.15	2.07	1100	1400	184	181	250	233	2.1	17.800
* 23134 E	2.39	3.56	2.34	1300	1700	195	182	268	250	2.1	21.550
* 24134 E	1.82	2.72	1.79	650	850	189	182	270	245	2.1	26.600
* 22234 E	2.6	3.87	2.54	1300	1700	201	187	293	277	4	28.177
23234 V	2.13	3.17	2.08	1000	1300	199	187	293	264	4	37.000
* 22334 E	2.09	3.11	2.04	1000	1200	223	187	343	313	4	59.000
* 23036 E	2.95	4.4	2.89	1400	1900	201	191	270	255	2.1	16.900
* 24036 E	2.03	3.02	1.98	1000	1300	198	191	270	250	2.1	22.900
* 23136 E	2.32	3.45	2.26	1200	1600	205	194	286	267	3	27.210
* 24136 E	1.78	2.65	1.74	600	800	200	194	286	261	3	33.900
* 22236 E	2.74	4.08	2.68	1300	1700	209	197	303	287	4	28.941
23236 V	2.17	3.23	2.12	1000	1300	210	197	303	274	4	39.800
22336 V	2.15	3.2	2.1	850	1100	223	197	363	313	4	67.300
* 23038 E	3.01	4.48	2.94	1400	1800	213	201	279	266	2.1	17.470
* 24038 E	2.15	3.2	2.1	1000	1300	206	201	279	261	2.1	22.530
23138 V	2.33	3.47	2.28	1000	1300	218	204	306	278	3	34.500

** These are the speed limits according to the SNR concept (see pages 85 to 87).

Double-row spherical roller bearings (continued)

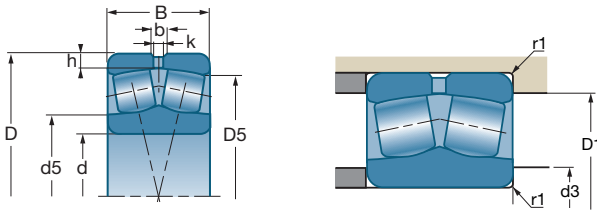

d		D	B	b	k	h			e
							10°N	10°N	
mm	References	mm	mm	mm	mm	mm	10°N	10°N	
190	* 24138 E	320	128	14.2	6	7	1760	2480	0.38
	* 22238 E	340	92	19.6	9	8.5	1540	1870	0.25
	23238 V	340	120	16.7	9	8.5	1480	2370	0.32
	22338 V	400	132	22.3	12	10	1830	2650	0.36
200	23940 V	280	60	12.2	6.3	6.2	620	1000	0.2
	* 23040 E	310	82	14.28	7	5.1	1250	1790	0.23
	* 24040 E	310	109	12.67	6	5.1	1440	2120	0.33
	23140 V	340	112	16.7	9	7	1290	2120	0.3
	* 24140 E	340	140	16.98	8	7	2030	2930	0.39
	* 22240 E	360	98	20	10	8.5	1720	2100	0.25
	23240 V	360	128	16.7	9	8.5	1630	2700	0.32
	22340 V	420	138	22.3	12	10	1830	2650	0.31
220	* 23944 E	300	60	13.7	6.3	6.2	665	1120	0.18
	* 23044 E	340	90	15.37	7	6.2	1450	2110	0.23
	24044 V	340	118	12.2	6.3	6.2	1400	2700	0.34
	23144 V	370	120	20.7	9	8.5	1540	2600	0.29
	24144 V	370	150	11.1	6.3	8.5	2340	3660	0.38
	* 22244 E	400	108	20.6	11	8.5	2100	2690	0.25
	* 23244 E	400	144	20.02	10	8.5	2750	3830	0.34
	22344 V	460	145	22.3	12	10	2110	3150	0.3
240	23048 V	360	92	13.9	7.5	6.2	1090	2050	0.24
	24048 V	360	118	12.2	6.3	6.2	1500	2900	0.32
	23148 V	400	128	16.7	9	8.5	1720	2950	0.29
	24148 V	400	160	11.1	6.3	8.5	2270	4240	0.38
	22248 V	440	120	22.3	12	8.5	1170	1950	0.29
	23248 V	440	160	22.3	12	8.5	2420	3950	0.33
	22348 V	500	155	22.3	12	10	2450	3700	0.29
	260	23052 V	400	104	16.7	9	7.3	1490	2430
24052 V		400	140	12.2	6.3	7.3	1900	3800	0.35
23152 V		440	144	16.7	9	8.5	2140	3750	0.29
24152 V		440	180	13.9	6.3	8.5	2770	5290	0.39
23252 V		480	174	22.3	12	13	2700	4450	0.33
280	23056 V	420	106	16.7	9	7.3	1500	2850	0.23
	24056 V	420	140	12.2	6.3	7.3	2000	4000	0.25
	23156 V	460	146	16.7	9	10	2240	4050	0.28
	24156 V	460	180	12.2	6.3	10	2700	5200	0.39
	23256 V	500	176	22.3	12	10	2900	4900	0.32
	22356 V	580	175	22.3	12	13	3429	5182	0.31

* indicate bearings of the range SNR PREMIER

■ Spherical double-row rollers with cylindrical bore (continued)





References	Y		Yo			d5	d3 min	D1 max	D5	r1 max	
	Fa — ≤ e Fr	Fa — > e Fr									
				rpm**	rpm**	mm	mm	mm	mm	mm	kg
* 24138 E	1.76	2.62	1.72	550	750	213	204	308	289	3	42.100
* 22238 E	2.74	4.08	2.68	1200	1600	222	207	323	305	4	35.314
23238 V	2.13	3.17	2.08	950	1200	223	207	323	290	4	48.500
22338 V	1.88	2.8	1.84	800	1100	240	210	380	332	5	76.400
23940 V	3.42	5.09	3.34	1300	1700	217	210	269	263	2.1	12.200
* 23040 E	2.95	4.4	2.89	1300	1700	223	211	300	283	2.1	22.560
* 24040 E	2.06	3.06	2.01	950	1200	219	211	299	278	2.1	29.200
23140 V	2.28	3.39	2.23	950	1200	230	214	326	294	3	42.500
* 24140 E	1.74	2.59	1.7	550	700	225	214	326	292	3	51.300
* 22240 E	2.74	4.08	2.68	1100	1500	234	217	343	323	4	42.528
23240 V	2.12	3.16	2.08	900	1200	238	217	343	307	4	58.400
22340 V	2.17	3.24	2.12	750	1000	302	220	400	346	5	99.000
* 23944 E	3.76	5.59	3.67	950	1200	237	230	287	284	4	12.300
* 23044 E	2.95	4.4	2.89	1200	1500	246	233	327	310	3	31.800
24044 V	1.96	2.92	1.92	850	1100	246	233	328	302	3	39.500
23144 V	2.31	3.44	2.26	900	1100	253	237	353	321	4	53.000
24144 V	1.77	2.63	0.73	500	670	253	237	353	316	4	65.600
* 22244 E	2.74	4.08	2.68	1000	1300	264	237	383	358	4	59.474
* 23244 E	2	2.98	1.96	850	1100	261	237	383	350	4	79.428
22344 V	2.23	3.32	2.18	700	950	332	240	440	380	5	125.000
23048 V	2.84	4.23	2.78	1000	1300	270	253	348	324	3	33.900
24048 V	2.1	3.13	2.06	800	1000	264	253	347	319	3	43.600
23148 V	2.35	3.5	2.3	800	1000	276	257	381	348	4	67.200
24148 V	1.79	2.67	1.75	460	620	270	257	383	342	4	81.300
22248 V	2.74	4.08	2.68	730	950	333	257	423	377	4	85.000
23248 V	2.07	3.07	2.02	750	950	285	257	423	372	4	113.180
22348 V	2.29	3.42	2.24	660	850	362	260	480	414	5	159.000
23052 V	2.73	4.07	2.67	950	1200	284	275	385	364	4	47.700
24052 V	1.94	2.88	1.89	750	950	291	275	385	354	4	67.200
23152 V	2.29	3.42	2.24	750	950	302	277	423	380	4	93.400
24152 V	1.75	2.6	1.71	420	560	294	277	423	373	4	113.000
23252 V	2.06	3.07	2.02	690	850	364	280	460	405	5	147.000
23056 V	3	4.46	2.93	900	1100	311	295	405	379	4	54.950
24056 V	2.74	4.08	2.68	700	900	318	295	405	375	4	70.500
23156 V	2.37	3.53	2.32	700	900	322	300	414	401	5	100.000
24156 V	1.71	2.54	1.67	400	530	315	300	440	396	5	119.000
23256 V	2.12	3.16	2.08	650	800	327	300	480	426	5	157.200
22356 V	2.17	3.24	2.12	600	750	437	306	554	493	6	232.000

** These are the speed limits according to the SNR concept (see pages 85 to 87).

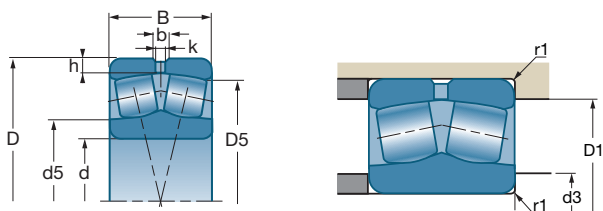
Double-row spherical roller bearings (continued)







d		D	B	b	k	h			e
							10°N	10°N	
mm	References	mm	mm	mm	mm	mm			
300	23060 V	460	118	16.7	9	7.3	1820	3350	0.23
	24060 V	460	160	12.2	6.3	7.3	2500	5200	0.35
	23160 V	500	160	22.4	9	10	2632	4645	0.29
	24160 V	500	200	12.2	6.3	10	3250	6300	0.4
	23260 V	540	192	22.3	12	13	3350	5600	0.32
320	23064 V	480	121	16.7	9	7.3	1920	3600	0.22
	23164 V	540	176	22.3	12	10	3050	5500	0.29
340	23068 V	520	133	22.3	12	8	2270	4200	0.23
	23168 V	580	190	22.3	12	10	3500	6100	0.29
360	23072 V	540	134	22.3	12	9	2390	4550	0.22
	23172 V	600	192	22.3	12	10	3681	6683	0.29
380	23076 V	560	135	22.3	12	9	2420	4700	0.21
400	23080 V	600	148	22.3	12	10	2926	5648	0.22

* indicate bearings of the range SNR PREMIER

■ Spherical double-row rollers with cylindrical bore (continued)





	Y		Yo			d5	d3 min	D1 max	D5	r1 max	
	$\frac{Fa}{Fr} \leq e$	$\frac{Fa}{Fr} > e$									
References				rpm**	rpm**	mm	mm	mm	mm	mm	kg
23060 V	2.95	4.4	2.89	800	1000	376	315	445	414	4	75.270
24060 V	1.95	2.9	1.91	650	800	343	315	445	407	4	102.000
23160 V	2.32	3.45	2.26	660	850	346	320	480	435	5	134.000
24160 V	1.67	2.49	1.63	370	490	340	320	480	429	5	159.000
23260 V	2.12	3.15	2.07	610	750	415	320	520	459	5	200.000
23064 V	3.01	4.49	2.95	750	1000	355	335	465	433	4	79.500
23164 V	2.31	3.44	2.26	620	800	363	340	520	468	5	171.000
23068 V	2.98	4.43	2.91	700	950	426	358	502	468	5	109.000
23168 V	2.29	3.42	2.24	580	750	455	360	560	501	5	208.600
23072 V	3.07	4.56	3	700	900	400	378	522	488	5	114.500
23172 V	2.36	3.51	2.31	560	700	475	380	580	522	5	231.600
23076 V	3.16	4.71	3.09	670	850	466	398	542	508	5	119.800
23080 V	3.08	4.59	3.02	600	750	497	418	582	542	5	156.000

** These are the speed limits according to the SNR concept (see pages 85 to 87).

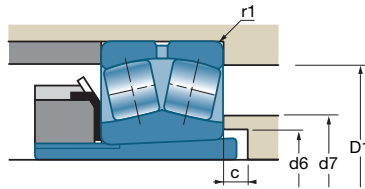
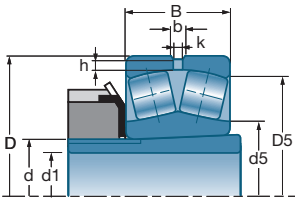
Double-row spherical roller bearings (continued)



d1		Sleeves	d	D	B	b	k	h			e
mm	References		mm	mm	mm	mm	mm	mm	10°N	10°N	
20	* 22205 EK	H305	25	52	18	3.0	1.5	2.8	54.4	46.1	0.34
	21305 VK	H305	25	62	17			3.5	48.5	37.5	0.29
25	* 22206 EK	H306	30	62	20	4.4	2.0	2.8	72	64.5	0.31
	21306 VK	H306	30	72	19			3.5	63	50	0.28
30	* 22207 EK	H307	35	72	23	4.9	2.0	3.5	95.4	92	0.31
	21307 VK	H307	35	80	21			4.5	79	66	0.27
35	* 22208 EK	H308	40	80	23	5.4	2.5	3.5	110	105	0.27
	21308 VK	H308	40	90	23			4.5	96	84	0.26
	* 22308 EK	H2308	40	90	33	5.9	3.0	4.5	161	152	0.36
40	* 22209 EK	H309	45	85	23	5.8	2.5	3.5	115	113	0.26
	21309 VK	H309	45	100	25			4.5	119	106	0.26
	* 22309 EK	H2309	45	100	36	6.4	3.0	4.5	196	187	0.36
45	* 22210 EK	H310	50	90	23	5.8	2.5	3.5	124	124	0.24
	21310 VK	H310	50	110	27			5.5	137	128	0.25
	* 22310 EK	H2310	50	110	40	7.4	3.5	5.5	237	232	0.36
50	* 22211 EK	H311	55	100	25	6.3	3.0	4.5	147	148	0.23
	21311 VK	H311	55	120	29			5.5	167	158	0.24
	* 22311 EK	H2311	55	120	43	7.8	3.5	5.5	282	274	0.36
55	* 22212 EK	H312	60	110	28	6.9	3.0	4.5	178	181	0.24
	21312 VK	H312	60	130	31			6.0	186	179	0.24
	* 22312 EK	H2312	60	130	46	8.7	4.0	6.0	323	319	0.35
60	* 22213 EK	H313	65	120	31	7.8	3.5	4.5	215	224	0.24
	21313 VK	H313	65	140	33			6.0	224	215	0.23
	* 22313 EK	H2313	65	140	48	9.2	4.0	6.0	351	343	0.33
60	* 22214 EK	H314	70	125	31	7.4	3.5	4.5	224	240	0.22
	21314 VK	H314	70	150	35			6.0	246	240	0.23
	* 22314 EK	H2314	70	150	51	10.4	5.0	6.0	400	396	0.34
65	* 22215 EK	H315	75	130	31	7.4	3.5	4.5	232	249	0.22
	21315 VK	H315	75	160	37			6.0	280	275	0.23
	* 22315 EK	H2315	75	160	55	10.3	5.0	6.0	467	467	0.34

* indicate bearings of the range SNR PREMIER

■ Spherical double-row rollers with tapered bore and adapter sleeves



References	Sleeves	Y		Yo			c	d6 min	d7 max	d5 ≈	D1 max	D5 ≈	r1 max	
		Fa ← ≤ e Fr	Fa → > e Fr		rpm**	rpm**								
* 22205 EK 21305 VK	H305 H305	2 2.33	2.98 3.47	1.96 2.28	8600 6800	11000 9100	5 5	28 31	30 33	30 34	47 55	46 52	1 1.1	0.160 0.254
* 22206 EK 21306 VK	H306 H306	2.15 2.45	3.2 3.64	2.1 2.39	7200 5800	9300 7700	5 5	33 36	37 39	37 40	57 65	55 60	1 1.1	0.260 0.384
* 22207 EK 21307 VK	H307 H307	2.21 2.48	3.29 3.69	2.16 2.42	6100 5200	7900 6900	5 7	39 39	43 44	45 46	66 71	63 68	1.1 1.5	0.420 0.505
* 22208 EK 21308 VK * 22308 EK	H308 H308 H2308	2.47 2.55 1.87	3.67 3.8 2.79	2.41 2.5 1.83	5500 4500 4100	7100 6100 5300	5 5 5	44 44 45	49 51 50	50 53 52	74 81 83	71 76 78	1.1 1.5 1.5	0.500 0.705 1.000
* 22209 EK 21309 VK * 22309 EK	H309 H309 H2309	2.64 2.64 1.9	3.93 3.93 2.83	2.58 2.58 1.86	5100 4100 3700	6600 5400 4800	7 5 5	50 50 50	53 57 56	54 59 58	79 91 93	76 85 87	1.1 1.5 1.5	0.545 0.935 1.340
* 22210 EK 21310 VK * 22310 EK	H310 H310 H2310	2.84 2.71 1.87	4.23 4.04 2.79	2.78 2.65 1.83	4800 3700 3400	6200 4900 4400	9 5 5	55 55 56	57 63 61	59 66 63	84 99 101	81 93 95	1.1 2 2	0.577 1.226 1.800
* 22211 EK 21311 VK * 22311 EK	H311 H311 H2311	2.95 2.82 1.87	4.4 4.2 2.79	2.89 2.76 1.83	4300 3300 3100	5500 4500 4000	10 6 6	60 60 61	64 70 66	66 73 68	93 109 111	90 102 104	1.5 2 2	0.766 1.520 2.270
* 22212 EK 21312 VK * 22312 EK	H312 H312 H2312	2.84 2.81 1.95	4.23 4.19 2.9	2.78 2.75 1.91	3900 3100 2900	5100 4100 3700	9 6 6	65 65 66	70 76 72	71 79 75	103 118 120	99 110 113	1.5 2.1 2.1	1.070 1.961 2.780
* 22213 EK 21313 VK * 22313 EK	H313 H313 H2313	2.79 2.91 2.06	4.15 4.33 3.06	2.73 2.84 2.01	3600 2900 2700	4700 3800 3400	8 6 6	70 70 72	76 81 78	78 85 81	113 128 130	107 120 122	1.5 2.1 2.1	1.450 2.380 3.370
* 22214 EK 21314 VK * 22314 EK	H314 H314 H2314	3.01 2.9 2	4.48 4.31 2.98	2.94 2.83 1.96	3400 2700 2500	4400 3600 3200	11 6 6	75 75 77	81 87 83	84 91 85	118 138 140	113 127 131	1.5 2.1 2.1	1.520 2.950 4.100
* 22215 EK 21315 VK * 22315 EK	H315 H315 H2315	3.14 2.94 2	4.67 4.37 2.98	3.07 2.87 1.96	3200 2500 2300	4200 3400 3000	12 6 6	80 80 82	86 93 89	88 97 91	123 148 150	118 137 139	1.5 2.1 2.1	1.560 3.550 5.000

** These are the speed limits according to the SNR concept (see pages 85 to 87).



Double-row spherical roller bearings (continued)

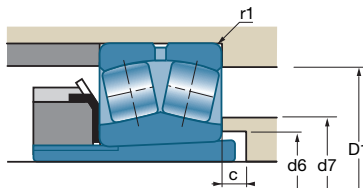
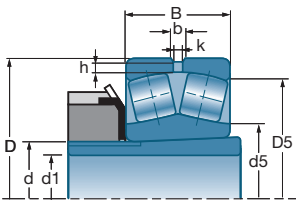

d1		Sleeves	d	D	B	b	k	h			e
mm	References		mm	mm	mm	mm	mm	mm	10°N	10°N	
70	* 22216 EK	H316	80	140	33	7.9	3.5	5.5	265	287	0.22
	* 21316 VK	H316	80	170	39			6.0	305	305	0.23
	* 22316 EK	H2316	80	170	58	10.4	5.0	6.0	515	522	0.34
75	* 22217 EK	H317	85	150	36	7.9	3.5	5.5	308	330	0.22
	* 21317 VK	H317	85	180	41			7.0	355	365	0.23
	* 22317 EK	H2317	85	180	60	11.0	5.0	7.0	570	604	0.32
80	* 22218 EK	H318	90	160	40	10.2	4.5	5.5	366	398	0.23
	* 23218 EK	H2318	90	160	52.4	8.9	4.0	5.5	445	513	0.3
	* 21318 VK	H318	90	190	43			7.0	385	400	0.23
	* 22318 EK	H2318	90	190	64	11.6	5.0	7.0	636	652	0.33
85	* 22219 EK	H319	95	170	43	9.9	4.5	6.0	395	417	0.23
	* 22319 EK	H2319	95	200	67	12.2	6.0	7.0	696	751	0.32
90	* 23120 EK	H3120	100	165	52	8.4	4.0	5.5	448	575	0.28
	* 22220 EK	H320	100	180	46	11.2	5.0	6.0	449	495	0.24
	* 23220 EK	H2320	100	180	60.3	9.4	4.5	6.0	558	661	0.31
	* 22320 EK	H2320	100	215	73	13.3	6.0	7.0	787	844	0.34
100	* 23022 EK	H322	110	170	45	7.8	3.5	4.4	397	517	0.23
	* 23122 EK	H3122	110	180	56	8.9	4.0	5.5	521	669	0.28
	* 22222 EK	H322	110	200	53	12.2	6.0	6.0	573	643	0.25
	* 23222 EK	H2322	110	200	69.8	10.5	5.0	6.0	716	869	0.32
	* 22322 EK	H2322	110	240	80	15.6	7.0	7.0	928	972	0.31
110	* 23024 EK	H3024	120	180	46	7.8	3.5	4.4	424	577	0.22
	* 23124 EK	H3124	120	200	62	10.0	4.5	5.5	630	820	0.28
	* 22224 EK	H3124	120	215	58	12.2	6.0	6.0	654	753	0.25
	* 23224 EK	H2324	120	215	76	11.0	5.0	6.0	815	998	0.32
	* 22324 EK	H2324	120	260	86	18.0	8.0	7.0	1110	1280	0.32
	* 23224 EK	H2324	120	260	86	18.0	8.0	7.0	1110	1280	0.32
115	* 23026 EK	H3026	130	200	52	8.9	4.0	4.4	538	721	0.22
	* 23126 EK	H3126	130	210	64	10.0	4.5	5.5	675	906	0.27
	* 22226 EK	H3126	130	230	64	13.2	6.0	7.0	768	898	0.25
	* 23226 EK	H2326	130	230	80	11.6	5.0	7.0	912	1130	0.32
	* 22326 EK	H2326	130	280	93	18.9	9.0	8.5	1260	1400	0.33
	* 23226 EK	H2326	130	280	93	18.9	9.0	8.5	1260	1400	0.33
125	* 23028 EK	H3028	140	210	53	8.9	4.0	4.4	568	783	0.22
	* 23128 EK	H3128	140	225	68	10.5	5.0	6.0	763	1030	0.26

* indicate bearings of the range SNR PREMIER

■ Spherical double-row rollers with tapered bore and adapter sleeves (continued)



References	Sleeves	Y		Yo			c	d6 min	d7 max	d5	D1 max	D5	r1 max	
		Fa Fr	e Fr		Fa Fr	< e Fr								
* 22216 EK	H316	3.14	4.67	3.07	3000	3900	12	85	92	94	131	127	2	2.041
21316 VK	H316	2.95	4.4	2.89	2400	3200	6	85	99	104	158	145	2.1	4.210
* 22317 EK	H2316	2	2.98	1.96	2200	2800	6	88	95	98	160	148	2.1	5.930
* 22217 EK	H317	3.07	4.57	3	2800	3600	12	91	98	100	141	137	2	2.520
21317 VK	H317	2.99	4.46	2.93	2200	3000	7	91	105	111	166	154	3	5.160
* 22317 EK	H2317	2.09	3.11	2.04	2000	2600	7	94	103	107	166	157	3	6.961
* 22218 EK	H318	2.9	4.31	2.83	2700	3500	10	96	102	105	151	144	2	3.240
* 23218 EK	H2318	2.25	3.34	2.2	2200	2900	18	100	108	104	149	141	2	4.210
21318 VK	H318	3	4.47	2.93	2100	2800	7	96	112	117	176	162	3	6.030
* 22318 EK	H2318	2.06	3.06	2.01	1900	2500	7	100	114	110	176	166	3	8.160
* 22219 EK	H319	2.95	4.4	2.89	2500	3200	9	102	114	110	158	153	2.1	3.850
* 22319 EK	H2319	2.09	3.11	2.04	1800	2300	7	105	122	122	186	174	3	9.610
* 23120 EK	H3120	2.39	3.56	2.34	2200	2900	7	107	112	114	154	147	2	4.400
* 22220 EK	H320	2.84	4.23	2.78	2400	3100	8	108	114	118	170	161	2.1	4.720
* 23220 EK	H2320	2.18	3.24	2.13	1900	2600	19	110	117	117	168	159	2.1	6.220
* 22320 EK	H2320	1.98	2.94	1.93	1700	2200	7	110	129	127	201	187	3	12.188
* 23022 EK	H322	2.95	4.4	2.89	2300	3000	14	118	125	125	161	155	2	3.450
* 23122 EK	H3122	2.43	3.61	2.37	2000	2700	7	118	128	126	169	161	2	5.310
* 22222 EK	H322	2.69	4	2.63	2200	2800	6	118	126	130	190	179	2.1	6.879
* 23222 EK	H2322	2.12	3.15	2.07	1700	2300	17	121	130	130	188	176	2.1	8.990
* 22322 EK	H2322	2.09	3.11	2.04	1600	2000	7	121	133	139	226	209	3	16.514
* 23024 EK	H3024	3.14	4.67	3.07	2200	2900	7	127	135	134	171	165	2	3.870
* 23124 EK	H3124	2.43	3.61	2.37	1800	2400	7	128	140	138	189	179	2	7.440
* 22224 EK	H3124	2.74	4.08	2.68	1900	2500	11	128	144	141	203	193	2.1	8.580
* 23224 EK	H2324	2.09	3.11	2.04	1600	2100	17	131	141	141	203	190	2.1	11.275
* 22324 EK	H2324	2.09	3.11	2.04	1400	1800	7	131	157	156	246	225	3	21.72
* 23026 EK	H3026	3.01	4.48	2.94	2000	2600	8	137	148	145	191	183	2	5.640
* 23126 EK	H3126	2.51	3.74	2.45	1700	2300	8	138	150	148	199	189	2	8.300
* 22226 EK	H3126	2.69	4	2.63	1800	2400	8	138	154	152	216	206	3	10.600
* 23226 EK	H2326	2.12	3.15	2.07	1500	2000	21	142	151	151	216	204	3	13.550
* 22326 EK	H2326	2.06	3.06	2.01	1300	1700	8	142	167	164	263	243	4	26.354
* 23028 EK	H3028	3.14	4.67	3.07	1900	2500	8	147	158	155	201	193	2	6.130
* 23128 EK	H3128	2.55	3.8	2.5	1600	2100	8	149	162	159	213	203	2.1	10.770

** These are the speed limits according to the SNR concept (see pages 85 to 87).



Double-row spherical roller bearings (continued)

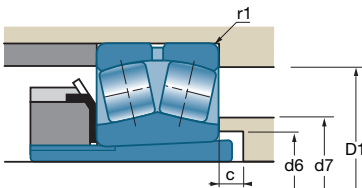
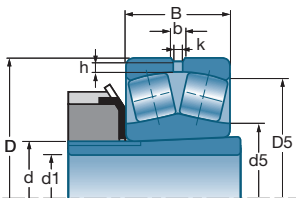

d1	References	Sleeves	d	D	B	b	k	h			e
									10°N	10°N	
mm			mm	mm	mm	mm	mm	mm			
125	* 22228 EK	H3128	140	250	68	14.2	7.0	7.0	867	1010	0.25
	* 23228 EK	H2328	140	250	88	12.6	6.0	7.0	1090	1370	0.33
	* 22328 EK	H2328	140	300	102	18.9	9.0	8.5	1470	1720	0.33
135	* 23030 EK	H3030	150	225	56	10.0	4.5	5.1	628	893	0.21
	* 23130 EK	H3130	150	250	80	12.6	6.0	6.0	1010	1350	0.29
	* 22230 EK	H3130	150	270	73	15.3	7.0	7.0	1020	1220	0.25
	* 23230 EK	H2330	150	270	96	13.7	6.0	7.0	1280	1620	0.33
	* 22330 EK	H2330	150	320	108	19.9	9.0	8.5	1660	1890	0.34
	* 23032 EK	H3032	160	240	60	10.5	5.0	5.1	711	1000	0.21
140	* 23132 EK	H3132	160	270	86	13.7	6.0	6.0	1160	1580	0.29
	* 22232 EK	H3132	160	290	80	16.9	8.0	7.0	1160	1390	0.25
	* 23232 EK	H2332	160	290	104	14.9	7.0	7.0	1470	1890	0.33
	* 22332 EK	H2332	160	340	114	20.3	10.0	8.5	1850	2210	0.33
	* 23034 EK	H3034	170	260	67	11.6	5.0	5.1	869	1240	0.22
	* 23134 EK	H3134	170	280	88	13.7	6.0	6.0	1200	1700	0.28
150	* 22234 EK	H3134	170	310	86	18.0	8.0	8.5	1330	1610	0.26
	* 23234 VK	H2334	170	310	110	13.9	7.5	8.5	1210	1830	0.32
	* 22334 EK	H2334	170	360	120	20.3	10.0	8.5	2100	2630	0.32
	* 23036 EK	H3036	180	280	74	13.2	6.0	5.1	1020	1450	0.23
160	* 23136 EK	H3136	180	300	96	14.9	7.0	7.0	1420	1960	0.29
	* 22236 EK	H3136	180	320	86	18.0	8.0	8.5	1380	1660	0.25
	* 23236 VK	H2336	180	320	112	13.9	7.5	8.5	1290	2050	0.31
	* 22336 VK	H2336	180	380	126	23.1	12.0	8.5	1580	2190	0.31
	* 23038 EK	H3038	190	290	75	13.2	6.0	5.1	1080	1570	0.22
170	* 23138 VK	H3138	190	320	104	20.0	7.5	7.0	1180	1950	0.29
	* 22238 EK	H3138	190	340	92	19.6	9.0	8.5	1540	1870	0.25
	* 23238 VK	H2338	190	340	120	16.7	9.0	8.5	1480	2370	0.32
	* 22338 VK	H2338	190	400	132	22.3	9.0	10.0	1830	2650	0.33
	* 23040 EK	H3040	200	310	82	14.3	7.0	5.1	1250	1790	0.23
180	* 23140 VK	H3140	200	340	112	16.7	9.0	7.0	1290	2120	0.3
	* 22240 EK	H3140	200	360	98	20.0	10.0	8.5	1720	2100	0.25
	* 23240 VK	H2340	200	360	128	16.7	9.0	8.5	1630	2700	0.32
	* 22340 VK	H2340	200	420	138	22.3	12.0	10.0	1830	2650	0.31

* indicate bearings of the range SNR PREMIER

■ Spherical double-row rollers with tapered bore and adapter sleeves (continued)



References	Sleeves	Y		Yo	rpm**		c	d6 min	d7 max	d5	D1 max	D5	r1 max	kg
		Fa ← ≤ e Fr	Fa → > e Fr		rpm**	rpm**								
* 22228 EK	H3128	2.74	4.08	2.68	1700	2200	8	149	166	163	236	224	3	14.000
* 23228 EK	H2328	2.06	3.06	2.01	1400	1800	22	152	165	162	236	220	3	18.400
* 22328 EK	H2328	2.03	3.02	1.98	1200	1600	8	152	175	181	283	261	4	33.390
* 23030 EK	H3030	3.2	4.77	3.13	1800	2300	8	158	169	167	214	207	2.1	7.750
* 23130 EK	H3130	2.35	3.5	2.3	1400	1900	8	160	176	171	238	223	2.1	15.720
* 22230 EK	H3130	2.74	4.08	2.68	1500	2000	15	160	180	177	256	242	3	17.600
* 23230 EK	H2330	2.03	3.02	1.98	1300	1700	20	163	177	174	256	237	2.1	22.800
* 22330 EK	H2330	2	2.98	1.96	1200	1500	8	163	192	188	303	279	4	41.200
* 23032 EK	H3032	3.2	4.77	3.13	1700	2200	8	168	180	177	229	221	2.1	9.380
* 23132 EK	H3132	2.35	3.5	2.3	1300	1800	8	170	185	185	258	240	2.1	20.120
* 22232 EK	H3132	2.69	4	2.63	1400	1900	14	170	191	190	276	260	3	22.800
* 23232 EK	H2332	2.03	3.02	1.98	1200	1600	18	174	189	186	276	259	3	28.710
* 22332 EK	H2332	2.03	3.02	1.98	1100	1400	8	174	207	205	323	296	4	50.000
* 23034 EK	H3034	3.07	4.57	3	1600	2000	8	179	194	190	249	238	2.1	13.000
* 23134 EK	H3134	2.39	3.56	2.34	1300	1700	8	180	204	195	268	250	2.1	21.550
* 22234 EK	H3134	2.6	3.87	2.54	1300	1700	10	180	204	201	293	277	4	28.000
23234 VK	H2334	2.13	3.17	2.08	1000	1300	18	185	203	199	293	264	4	36.100
* 22334 EK	H2334	2.09	3.11	2.04	1000	1200	8	185	214	223	343	313	4	59.000
* 23036 EK	H3036	2.95	4.4	2.89	1400	1900	8	189	207	201	276	255	2.1	16.900
* 23136 EK	H3136	2.32	3.45	2.26	1200	1600	8	191	208	205	286	267	3	27.210
* 22236 EK	H3136	2.74	4.08	2.68	1300	1700	18	191	203	209	303	287	4	28.700
23236 VK	H2336	2.17	3.23	2.12	1000	1300	22	195	213	210	303	274	4	39.600
22336 VK	H2336	2.15	3.2	2.1	850	1100	8	195	226	223	363	313	4	66.300
* 23038 EK	H3038	3.01	4.48	2.94	1400	1800	9	199	214	213	279	266	2.1	17.200
23138 VK	H3138	2.33	3.47	2.28	1000	1300	9	202	221	218	306	278	3	33.500
* 22238 EK	H3138	2.74	4.08	2.68	1200	1600	21	202	215	222	323	305	4	35.000
23238 VK	H2338	2.13	3.17	2.08	950	1200	21	206	225	223	323	290	4	47.400
22338 VK	H2338	1.88	2.8	1.84	800	1100	9	206	241	240	380	332	5	75.000
* 23040 EK	H3040	2.95	4.4	2.89	1300	1700	9	210	227	223	300	283	2.1	22.560
23140 VK	H3140	2.28	3.39	2.23	950	1200	9	212	233	230	326	294	3	41.400
* 22240 EK	H3140	2.74	4.08	2.68	1100	1500	23	212	227	234	343	323	4	42.000
23240 VK	H2340	2.12	3.16	2.08	900	1100	19	216	237	238	343	307	4	58.100
22340 VK	H2340	2.17	3.24	2.12	750	1000	9	216	247	302	400	346	5	97.000

** These are the speed limits according to the SNR concept (see pages 85 to 87).



Double-row spherical roller bearings (continued)

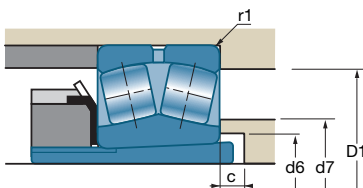
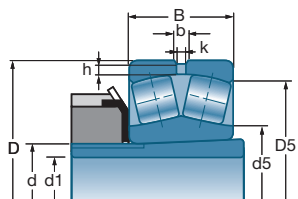

d1		Sleeves	d	D	B	b	k	h			e
mm	References		mm	mm	mm	mm	mm	mm	10°N	10°N	
200	* 23044 EK	H3044H	220	340	90	15.4	7.0	6.2	1450	2110	0.23
	23144 VK	H3144H	220	370	120	20.7	9.0	8.5	1540	2600	0.29
	* 22244 EK	H3144H	220	400	108	20.6	11.0	8.5	2100	2690	0.25
	* 23244 EK	H2344H	220	400	144	20.0	10.0	8.5	2750	3830	0.34
	22344 VK	H2344H	220	460	145	22.3	12.0	10.0	2110	3150	0.3
220	23048 VK	H3048H	240	360	92	13.9	7.5	6.2	1090	2050	0.24
	23148 VK	H3148H	240	400	128	16.7	9.0	8.5	1720	2950	0.29
	22248 VK	H3148H	240	440	120	22.3	12.0	8.5	1920	2470	0.29
	23248 VK	H2348H	240	440	160	22.3	12.0	8.5	2420	3950	0.33
	22348 VK	H2348H	240	500	155	22.3	12.0	10.0	2450	3700	0.29
240	23052 VK	H3052H	260	400	104	16.7	9.0	7.3	1490	2430	0.25
	23152 VK	H3152H	260	440	144	16.7	9.0	8.5	2140	3750	0.29
	23252 VK	H2352H	260	480	174	22.3	12.0	13.0	2700	4450	0.33
260	23056 VK	H3056H	280	420	106	16.7	9.0	7.3	1500	2850	0.23
	23156 VK	H3156H	280	460	146	16.7	9.0	10.0	2240	4050	0.28
	23256 VK	H2356H	280	500	176	22.3	12.0	10.0	2900	4900	0.32
	22356 VK	H2356H	280	580	175	22.3	12.0	13.0	3429	5182	0.32
280	23060 VK	H3060H	300	460	118	16.7	9.0	7.3	1820	3350	0.23
	23160 VK	H3160H	300	500	160	16.7	9.0	10.0	2632	4645	0.32
	23260 VK	H3260H	300	540	192	22.3	12.0	13.0	3350	5600	0.32
300	23064 VK	H3064H	320	480	121	16.7	9.0	7.3	1920	3600	0.22
	23164 VK	H3164H	320	540	176	22.3	12.0	10.0	3050	5500	0.29
320	23068 VK	H3068H	340	520	133	22.3	12.0	8.0	2270	4200	0.23
	23168 VK	H3168H	340	580	190	22.3	12.0	10.0	3500	6100	0.29
340	23072 VK	H3072H	360	540	134	22.3	12.0	9.0	2390	4550	0.22
	23172 VK	H3172H	360	600	192	22.3	12.0	10.0	3681	6683	0.29
360	23076 VK	H3076H	380	560	135	22.3	12.0	9.0	2420	4700	0.21
380	23080 VK	H3080H	400	600	148	22.3	12.0	10.0	2926	5648	0.22

* indicate bearings of the range SNR PREMIER

■ Spherical double-row rollers with tapered bore and adapter sleeves (continued)



References	Sleeves	Y		Yo			c	d6 min	d7 max	d5	D1 max	D5	r1 max	
		Fa Fr	Fa Fr		rpm**	rpm**								
* 23044 EK 23144 VK	H3044H H3144H	2.95 2.31	4.4 3.44	2.89 2.26	1200 900	1500 1100	9	231	249	246	327	310	3	31.450
* 22244 EK	H3144H	2.74	4.08	2.68	1000	1300	21	233	254	264	383	358	4	59.000
* 23244 EK 22344 VK	H2344H H2344H	2 2.23	2.98 3.32	1.96 2.18	850 700	1100 950	10 9	236 236	259 273	261 332	383 440	350 380	4 5	74.800 122.000
23048 VK 23148 VK 22248 VK 23248 VK 22348 VK	H3048H H3148H H3148H H2348H H2348H	2.84 2.35 2.3 2.07 2.29	4.23 3.5 3.42 3.07 3.42	2.78 2.3 2.25 2.02 2.24	1000 800 730 750 660	1300 1000 950 950 850	11 11 19 6 11	251 254 284 257 257	267 277 284 281 297	270 276 333 423 362	348 381 423 377 480	324 348 423 423 414	3 4 4 4 5	32.700 65.500 85.000 112.000 156.000
23052 VK 23152 VK 23252 VK	H3052H H3152H H2352H	2.73 2.29 2.06	4.07 3.42 3.07	2.67 2.24 2.02	950 750 690	1200 950 850	11 11 2	272 276 278	292 302 312	284 302 364	385 420 460	364 380 405	4 4 5	45.800 91.600 142.000
23056 VK 23156 VK 23256 VK 22356 VK	H3056H H3156H H2356H H2356H	3 2.37 2.12 2.13	4.46 3.53 3.16 3.17	2.93 2.32 2.08 2.08	900 700 650 950	1100 900 800 670	12 12 11 12	292 296 299 299	315 314 239 345	311 322 327 437	405 414 480 554	379 401 426 493	4 5 5 6	53.310 98.000 152.000 232.000
23060 VK 23160 VK 23260 VK	H3060H H3160H H3260H	2.95 2.1 2.12	4.4 3 3.15	2.89 2 2.07	800 670 610	1000 850 750	12 12 12	313 318 321	336 245 356	376 346 415	445 480 520	414 435 459	4 5 5	73.100 129.700 195.000
23064 VK 23164 VK	H3064H H3164H	3.01 2.31	4.49 3.44	2.95 2.26	750 620	1000 800	12 12	334 338	357 373	355 369	465 520	433 468	4 5	79.100 168.500
23068 VK 23168 VK	H3068H H3168H	2.98 2.29	4.43 3.42	2.91 2.24	700 580	950 750	14 14	355 360	385 394	426 455	502 560	468 501	5 5	105.000 202.200
23072 VK 23172 VK	H3072H H3172H	3.07 2.36	4.56 3.51	3 2.31	700 560	900 700	14 14	375 380	403 418	400 475	522 580	488 522	5 5	110.700 223.800
23076 VK	H3076H	3.16	4.71	3.09	670	850	15	396	425	466	542	508	5	116.200
23080 VK	H3080H	3.08	4.59	3.02	600	750	15	417	450	497	582	542	5	155.000

** These are the speed limits according to the SNR concept (see pages 85 to 87).



Double-row spherical roller bearings (continued)

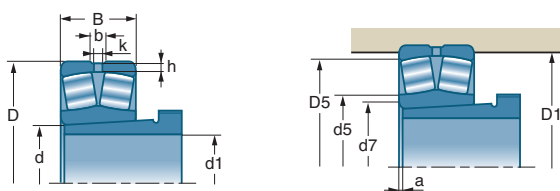

d1		Sleeves	d	D	B	b	k	h	C		e
									10°N	10°N	
mm	References		mm	mm	mm	mm	mm	mm	mm	mm	mm
20	* 22205 EK 21305 VK		25	52	18	3.0	1.5	2.8	54.40	46.10	0.34
			25	62	17			3.5	48.50	37.50	0.29
25	* 22206 EK 21306 VK		30	62	20	4.4	2.0	2.8	72.00	64.50	0.31
			30	72	19			3.5	63.00	50.00	0.28
30	* 22207 EK 21307 VK		35	72	23	4.9	2.0	3.5	95.40	92.00	0.31
			35	80	21			4.5	79.00	66.00	0.27
35	* 22208 EK 21308 VK * 22308 EK	AH308	40	80	23	5.4	2.5	3.5	110.00	105.00	0.27
		AH308	40	90	23			4.5	96.00	84.00	0.26
		AH2308	40	90	33	5.9	3.0	4.5	161.00	152.00	0.36
40	* 22209 EK 21309 VK * 22309 EK	AH309	45	85	23	5.8	2.5	3.5	115.00	113.00	0.26
		AH309	45	100	25			4.5	119.00	106.00	0.26
		AH2309	45	100	36	6.4	3.0	4.5	196.00	187.00	0.36
45	* 22210 EK 21310 VK * 22310 EK	AHX310	50	90	23	5.8	2.5	3.5	124.00	124.00	0.24
		AHX310	50	110	27			5.5	137.00	128.00	0.25
		AHX2310	50	110	40	7.4	3.5	5.5	237.00	232.00	0.36
50	* 22211 EK 21311 VK * 22311 EK	AHX311	55	100	25	6.3	3.0	4.5	147.00	148.00	0.23
		AHX311	55	120	29			5.5	167.00	158.00	0.24
		AHX2311	55	120	43	7.8	3.5	5.5	282.00	274.00	0.36
55	* 22212 EK 21312 VK * 22312 EK	AHX312	60	110	28	6.9	3.0	4.5	178.00	181.00	0.24
		AHX312	60	130	31			6.0	186.00	179.00	0.24
		AHX2312	60	130	46	8.7	4.0	6.0	323.00	319.00	0.35
60	* 22213 EK 21313 VK * 22313 EK	AH313G	65	120	31	7.8	3.5	4.5	215.00	224.00	0.24
		AH313G	65	140	33			6.0	224.00	215.00	0.23
		AH2313G	65	140	48	9.2	4.0	6.0	351.00	343.00	0.33
65	* 22214 EK 21314 VK * 22314 EK	AH314G	70	125	31	7.4	3.5	4.5	224.00	240.00	0.22
		AH314G	70	150	35			6.0	246.00	240.00	0.23
		AHX2314G	70	150	51	10.4	5.0	6.0	400.00	396.00	0.34
70	* 22215 EK 21315 VK * 22315 EK	AH315	75	130	31	7.4	3.5	4.5	232.00	249.00	0.22
		AH315	75	160	37			6.0	280.00	275.00	0.23
		AHX2315G	75	160	55	10.3	5.0	6.0	467.00	467.00	0.34

* indicate bearings of the range SNR PREMIER

■ Spherical double-row rollers with tapered bore and withdrawal sleeves



References	Sleeves	Y		Yo	rpm		d7 max	a	d5	D1 max	D5	r1 max	kg
		Fa ← ≤ e Fr	Fa → > e Fr		rpm**	rpm**							
* 22205 EK 21 305 VK		2.00 2.33	2.98 3.47	1.96 2.28	8600 6800	11000 9100	30 33		30 34	47 55	46 52	1.0 1.1	0.160 0.254
* 22206 EK 21306 VK		2.15 2.45	3.20 3.64	2.10 2.39	7200 5800	9300 7700	37 39		37 40	57 65	55 60	1.0 1.1	0.260 0.384
* 22207 EK 21307 VK		2.21 2.48	3.29 3.69	2.16 2.42	6100 5200	7900 6900	43 44		45 46	66 71	63 68	1.1 1.5	0.420 0.505
* 22208 EK 21308 VK	AH308	2.47	3.67	2.41	5500	7100	49	3	50	74	71	1.1	0.500
	AH308	2.55	3.80	2.50	4500	6100	51	3	53	81	76	1.5	0.705
* 22308 EK	AH2308	1.87	2.79	1.83	4100	5300	50	3	52	83	78	1.5	1.000
* 22209 EK 21309 VK	AH309	2.64	3.93	2.58	5100	6600	53	3	54	79	76	1.1	0.545
	AH309	2.64	3.93	2.58	4100	5400	57	3	59	91	85	1.5	0.935
* 22309 EK	AH2309	1.90	2.83	1.86	3700	4800	56	3	58	93	87	1.5	1.340
* 22210 EK 21310 VK	AHX310	2.84	4.23	2.78	4800	6200	57	3	59	84	81	1.1	0.577
	AHX310	2.71	4.04	2.65	3700	4900	63	3	66	99	93	2.0	1.226
* 22310 EK	AHX2310	1.87	2.79	1.83	3400	4400	61	3	63	101	95	2.0	1.800
* 22211 EK 21311 VK	AHX311	2.95	4.40	2.89	4300	5500	64	3	66	93	90	1.5	0.766
	AHX311	2.82	4.20	2.76	3300	4500	70	3	73	109	102	2.0	1.520
* 22311 EK	AHX2311	1.87	2.79	1.83	3100	4000	66	3	68	111	104	2.0	2.270
* 22212 EK 21312 VK	AHX312	2.84	4.23	2.78	3900	5100	70	3	71	103	99	1.5	1.070
	AHX312	2.81	4.19	2.75	3100	4100	76	3	79	118	110	2.1	1.961
* 22312 EK	AHX2312	1.95	2.90	1.91	2900	3700	72	3	75	120	113	2.1	2.780
* 22213 EK 21313 VK	AH313G	2.79	4.15	2.73	3600	4700	76	3	78	113	107	1.5	1.450
	AH313G	2.91	4.33	2.84	2900	3800	81	3	85	128	120	2.1	2.380
* 22313 EK	AH2313G	2.06	3.06	2.01	2700	3400	78	3	81	130	122	2.1	3.370
* 22214 EK 21314 VK	AH314G	3.01	4.48	2.94	3400	4400	81	4	84	118	113	1.5	1.520
	AH314G	2.90	4.31	2.83	2700	3600	87	4	91	138	127	2.1	2.950
* 22314 EK	AHX2314G	2.00	2.98	1.96	2500	3200	83	4	85	140	131	2.1	4.100
* 22215 EK 21315 VK	AH315	3.14	4.67	3.07	3200	4200	86	4	88	123	118	1.5	1.560
	AH315	2.94	4.37	2.87	2500	3400	93	4	97	148	137	2.1	3.550
* 22315 EK	AHX2315G	2.00	2.98	1.96	2300	3000	89	4	91	150	139	2.1	5.000

** These are the speed limits according to the SNR concept (see pages 85 to 87).



Double-row spherical roller bearings (continued)

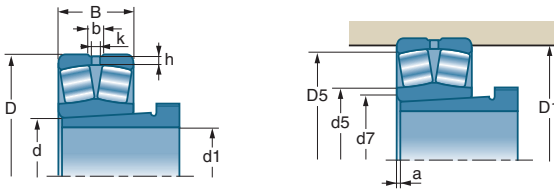

d1		Sleeves	d	D	B	b	k	h			e
									10°N	10°N	
mm	References		mm	mm	mm	mm	mm	mm	C	C ₀	
75	* 22216 EK	AH316	80	140	33	7.9	3.5	5.5	265.00	287.00	0.22
	21316 VK	AH316	80	170	39			6.0	305.00	305.00	0.23
	* 22316 EK	AHX2316	80	170	58	10.4	5.0	6.0	515.00	522.00	0.34
80	* 22217 EK	AHX317	85	150	36	7.9	3.5	5.5	308.00	330.00	0.22
	21317 VK	AHX317	85	180	41			7.0	355.00	365.00	0.23
	* 22317 EK	AHX2317	85	180	60	11.0	5.0	7.0	570.00	604.00	0.32
85	* 22218 EK	AHX318	90	160	40	10.2	4.5	5.5	366.00	398.00	0.23
	* 23218 EK	AHX3218	90	160	52.4	8.9	4.0	5.5	445.00	513.00	0.30
	21318 VK	AHX318	90	190	43			7.0	385.00	400.00	0.23
	* 22318 EK	AHX2318	90	190	64	11.6	5.0	7.0	636.00	652.00	0.33
90	* 22219 EK	AHX319	95	170	43	9.9	4.5	6.0	395.00	417.00	0.23
	* 22319 EK	AHX2319	95	200	67	12.2	6.0	7.0	696.00	751.00	0.32
95	* 23120 EK	AHX3120	100	165	52	8.4	4.0	5.5	448.00	575.00	0.28
	* 22220 EK	AHX320	100	180	46	11.2	5.0	6.0	449.00	495.00	0.24
	* 23220 EK	AHX3220	100	180	60.3	9.4	4.5	6.0	558.00	661.00	0.31
	* 22320 EK	AHX2320	100	215	73	13.3	6.0	7.0	787.00	844.00	0.34
105	* 23022 EK	AHX3121	110	170	45	7.8	3.5	4.4	397.00	517.00	0.23
	* 23122 EK	AHX3122	110	180	56	8.9	4.0	5.5	521.00	669.00	0.28
	* 24122 EK	AH24122	110	180	69	8.4	4.0	5.5	530.00	675.00	0.36
	* 22222 EK	AHX3122	110	200	53	12.2	6.0	6.0	573.00	643.00	0.25
	* 23222 EK	AHX3222G	110	200	69.8	10.5	5.0	6.0	716.00	869.00	0.32
	* 22322 EK	AHX2322G	110	240	80	15.6	7.0	7.0	928.00	972.00	0.31
	115	* 23024 EK	AHX3024	120	180	46	7.8	3.5	4.4	424.00	577.00
* 24024 EK30		AH24024	120	180	60	7.3	3.5	4.4	465.00	640.00	0.30
* 23124 EK		AHX3124	120	200	62	10.0	4.5	5.5	630.00	820.00	0.28
* 24124 EK30		AH24124	120	200	80	10.1	4.5	5.5	695.00	925.00	0.39
* 22224 EK		AHX3124	120	215	58	12.2	6.0	6.0	654.00	753.00	0.25
* 23224 EK		AHX3224G	120	215	76	11.0	5.0	6.0	815.00	998.00	0.32
* 22324 EK		AHX2324G	120	260	86	18.0	8.0	7.0	1110.00	1280.00	0.32
125		* 23026 EK	AHX3026	130	200	52	8.9	4.0	4.4	538.00	721.00
	* 24026 EK30	AH24026	130	200	69	8.4	4.0	4.4	590.00	795.00	0.32
	* 23126 EK	AHX3126	130	210	64	10.0	4.5	5.5	675.00	906.00	0.27
	* 24126 EK30	AH24126	130	210	80	9.5	4.5	5.5	720.00	965.00	0.35
	* 22226 EK	AHX3126	130	230	64	13.2	6.0	7.0	768.00	898.00	0.25

* indicate bearings of the range SNR PREMIER

■ Spherical double-row rollers with tapered bore and withdrawal sleeves (continued)



References	Sleeves	Y		Yo	rpm**		d7 max	a	d5	D1 max	D5	r1 max	kg
		Fa — ≤ e Fr	Fa — > e Fr		rpm**	rpm**							
* 22216 EK 21316 VK * 22316 EK	AH316 AH316 AHX2316	3.14 2.95 2.00	4.67 4.40 2.98	3.07 2.89 1.96	3000 2400 2200	3900 3200 2800	92 99 95	4 4 4	94 104 98	131 158 160	127 145 148	2.0 2.1 2.1	2.041 4.210 5.930
* 22217 EK 21317 VK * 22317 EK	AHX317 AHX317 AHX2317	3.07 2.99 2.09	4.57 4.46 3.11	3.00 2.93 2.04	2800 2200 2000	3600 3000 2600	98 105 103	4 4 4	100 111 107	141 166 166	137 154 157	2.0 3.0 3.0	2.520 5.160 6.961
* 22218 EK * 23218 EK 21318 VK * 22318 EK	AHX318 AHX3218 AHX318 AHX2318	2.90 2.25 3.00 2.06	4.31 3.34 4.47 3.06	2.83 2.20 2.93 2.01	2700 2200 2100 1900	3500 2900 2800 2500	102 108 112 114	4 4 4 4	105 104 117 110	151 149 176 176	144 141 162 166	2.0 2.0 3.0 3.0	3.240 4.210 6.030 8.160
* 22219 EK * 22319 EK	AHX319 AHX2319	2.95 2.09	4.40 3.11	2.89 2.04	2500 1800	3200 2300	114 122	4 4	110 122	158 186	153 174	2.1 3.0	3.850 9.610
* 23120 EK * 22220 EK * 23220 EK * 22320 EK	AHX3120 AHX320 AHX3220 AHX2320	2.39 2.84 2.18 1.98	3.56 4.23 3.24 2.94	2.34 2.78 2.13 1.93	2200 2400 1900 1700	2900 3100 2600 2200	112 114 119 129	4 4 4 4	114 118 118 127	154 170 168 201	147 161 159 187	2.0 2.1 2.1 3.0	4.400 4.720 6.220 12.188
* 23022 EK * 23122 EK * 24122 EK * 22222 EK * 23222 EK * 22322 EK	AHX3121 AHX3122 AH24122 AHX3122 AHX3222G AHX2322G	2.95 2.43 1.85 2.69 2.12 2.09	4.40 3.61 2.76 4.00 3.15 3.11	2.89 2.37 1.81 2.63 2.07 2.04	2300 2000 1800 2200 1700 2000	3000 2700 1300 2800 2300 2000	125 128 128 126 133 133	4 4 9 4 4 4	123 125 121 130 130 139	161 169 169 190 188 226	155 161 158 179 176 209	2.0 2.0 2.0 2.1 2.1 3.0	3.450 5.310 6.750 6.879 8.990 16.514
* 23024 EK * 24024 EK30 * 23124 EK * 24124 EK30 * 22224 EK * 23224 EK * 22324 EK	AHX3024 AH24024 AHX3124 AH24124 AHX3124 AHX3224G AHX2324G	3.14 2.25 2.43 1.74 2.74 2.09 2.09	4.67 3.34 3.61 2.59 4.08 3.11 3.11	3.07 2.20 2.37 1.70 2.68 2.04 2.04	2200 1700 1800 950 1900 1600 1400	2900 2100 2400 1200 2500 2100 1800	135 129 140 131 144 143 157	4 9 4 9 4 4 4	134 131 138 133 141 139 156	171 171 189 189 203 203 246	165 165 179 172 193 190 225	2.0 2.0 2.0 2.0 2.1 2.1 3.0	3.870 5.000 7.440 9.700 8.580 11.275 21.720
* 23026 EK * 24026 EK30 * 23126 EK * 24126 EK30 * 22226 EK	AHX3026 AH24026 AHX3126 AH24126 AHX3126	3.01 2.09 2.51 1.92 2.69	4.48 3.11 3.74 2.86 4.00	2.94 2.04 2.45 1.88 2.63	2000 1500 1700 850 1800	2600 1900 2300 1200 2400	148 139 150 142 154	4 10 4 10 4	145 141 148 144 151	191 191 199 199 216	183 179 189 184 206	2.0 2.0 2.0 2.0 3.0	5.640 7.500 8.300 11.400 10.600

** These are the speed limits according to the SNR concept (see pages 85 to 87).



Double-row spherical roller bearings (continued)

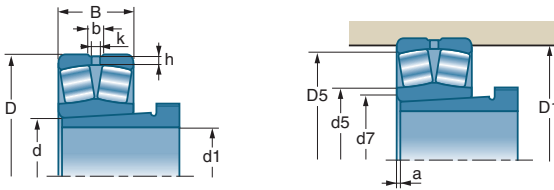

d1	Sleeves		d	D	B	b	k	h	C		e
	10°N	10°N									
mm	References		mm	mm	mm	mm	mm	mm	10°N	10°N	
125	* 23226 EK	AHX3226G	130	230	80	11.6	5.0	7.0	912.00	1130.00	0.32
	* 22326 EK	AHX2326G	130	280	93	18.9	9.0	8.5	1260.00	1400.00	0.33
135	* 23028 EK	AHX3028	140	210	53	8.9	4.0	4.4	568.00	783.00	0.22
	* 24028 EK30	AH24028	140	210	69	9.9	4.5	4.4	625.00	900.00	0.31
	* 23128 EK	AHX3128	140	225	68	10.5	5.0	6.0	763.00	1030.00	0.26
	* 24128 EK30	AH24128	140	225	85	10.7	4.5	6.0	830.00	1120.00	0.36
	* 22228 EK	AHX3128	140	250	68	14.2	7.0	7.0	867.00	1010.00	0.25
	* 23228 EK	AHX3228G	140	250	88	12.6	6.0	7.0	1090.00	1370.00	0.33
	* 22328 EK	AHX2328G	140	300	102	18.9	9.0	8.5	1470.00	1720.00	0.33
145	* 23030 EK	AHX3030	150	225	56	10.0	4.5	5.1	628.00	893.00	0.21
	* 24030 EK30	AH24030	150	225	75	9.3	4.5	5.1	715.00	1000.00	0.31
	* 23130 EK	AHX3130G	150	250	80	12.6	6.0	6.0	1010.00	1350.00	0.29
	* 24130 EK30	AH24130	150	250	100	10.4	5.0	6.0	1070.00	1400.00	0.38
	* 22230 EK	AHX3130G	150	270	73	15.3	7.0	7.0	1020.00	1220.00	0.25
	* 23230 EK	AHX3230G	150	270	96	13.7	6.0	7.0	1280.00	1620.00	0.33
	* 22330 EK	AHX2330G	150	320	108	19.9	9.0	8.5	1660.00	1890.00	0.34
150	* 23032 EK	AH3032	160	240	60	10.5	5.0	5.1	711.00	1000.00	0.21
	* 24032 EK30	AH24032	160	240	80	9.4	4.5	5.1	785.00	1090.00	0.30
	* 23132 EK	AH3132G	160	270	86	13.7	6.0	6.0	1160.00	1580.00	0.29
	* 24132 EK30	AH24132	160	270	109	11.7	5.0	6.0	1260.00	1740.00	0.38
	* 22232 EK	AH3132G	160	290	80	16.9	8.0	7.0	1160.00	1390.00	0.25
	* 23232 EK	AH3232G	160	290	104	14.9	7.0	7.0	1470.00	1890.00	0.33
	* 22332 EK	AH2332G	160	340	114	20.3	10.0	8.5	1850.00	2210.00	0.33
160	* 23034 EK	AH3034	170	260	67	11.6	5.0	5.1	869.00	1240.00	0.22
	* 24034 EK30	AH34034	170	260	90	10.5	5.0	5.1	1010.00	1430.00	0.32
	* 23134 EK	AH3134G	170	280	88	13.7	6.0	6.0	1200.00	1700.00	0.28
	* 24134 EK30	AH24134	170	280	109	13.2	6.0	6.0	1310.00	1840.00	0.37
	* 22234 EK	AH3134G	170	310	86	18.0	8.0	8.5	1330.00	1610.00	0.26
	* 23234 VK	AH3234G	170	310	110	13.9	7.5	8.5	1210.00	1830.00	0.32
	* 22334 EK	AH2334G	170	360	120	20.3	10.0	8.5	2100.00	2630.00	0.32
170	* 23036 EK	AH3036	180	280	74	13.2	6.0	5.1	1020.00	1450.00	0.23
	* 24036 EK30	AH24036	180	280	100	11.7	5.0	5.1	1170.00	1700.00	0.33
	* 23136 EK	AH3136G	180	300	96	14.9	7.0	7.0	1420.00	1960.00	0.29
	* 24136 EK30	AH24136	180	300	118	14.1	6.0	7.0	1470.00	2050.00	0.38
	* 22236 EK	AH2236G	180	320	86	18.0	8.0	8.5	1380.00	1660.00	0.25
	* 23236 VK	AH3236G	180	320	112	13.9	7.5	8.5	1290.00	2050.00	0.31
	* 22336 VK	AH2336G	180	380	126	23.1	12.0	8.5	1580.00	2190.00	0.31

* indicate bearings of the range SNR PREMIER

■ Spherical double-row rollers with tapered bore and withdrawal sleeves (continued)



References	Sleeves	Y		Yo			d7 max	a	d5	D1 max	D5	r1 max	
		Fa — ≤ e Fr	Fa — > e Fr		rpm**	rpm**							
* 23226 EK	AHX3226G	2.12	3.15	2.07	1500	2000	152	4	150	216	204	3.0	13.550
* 22326 EK	AHX2326G	2.06	3.06	2.01	1300	1700	167	4	164	263	243	4.0	26.354
* 23028 EK	AHX3028	3.14	4.67	3.07	1900	2500	158	5	155	201	193	2.0	6.130
* 24028 EK30	AH24028	2.21	3.29	2.16	1400	1800	151	10	153	201	189	2.0	8.800
* 23128 EK	AHX3128	2.55	3.80	2.50	1600	2100	162	5	159	213	203	2.1	10.770
* 24128 EK30	AH24128	1.90	2.83	1.86	800	1100	151	10	154	213	198	2.1	12.500
* 22228 EK	AHX3128	2.74	4.08	2.68	1700	2200	166	5	163	236	224	3.0	14.000
* 23228 EK	AHX3228G	2.06	3.06	2.01	1400	1800	166	5	162	236	220	3.0	18.400
* 22328 EK	AHX2328G	2.03	3.02	1.98	1200	1600	175	5	181	283	261	4.0	33.390
* 23030 EK	AHX3030	3.20	4.77	3.13	1800	2300	169	5	167	214	207	2.1	7.750
* 24030 EK30	AH24030	2.18	3.24	2.13	1300	1600	161	11	162	215	205	2.1	9.350
* 23130 EK	AHX3130G	2.35	3.50	2.30	1400	1900	176	5	171	238	223	2.1	15.720
* 24130 EK30	AH24130	1.78	2.65	1.74	850	1100	162	11	165	240	219	2.1	19.600
* 22230 EK	AHX3130G	2.74	4.08	2.68	1500	2000	180	5	177	256	242	3.0	17.600
* 23230 EK	AHX3230G	2.03	3.02	1.98	1300	1700	177	5	174	256	237	2.1	22.800
* 22330 EK	AHX2330G	2.00	2.98	1.96	1200	1500	192	5	188	303	279	4.0	41.200
* 23032 EK	AH3032	3.20	4.77	3.13	1700	2200	180	5	177	229	221	2.1	9.380
* 24032 EK30	AH24032	2.28	3.39	2.23	1200	1500	171	11	173	230	217	2.1	12.000
* 23132 EK	AH3132G	2.35	3.50	2.30	1300	1800	185	5	185	258	240	2.1	20.120
* 24132 EK30	AH24132	1.76	2.62	1.72	800	1000	171	11	180	260	236	2.1	25.000
* 22232 EK	AH3132G	2.69	4.00	2.63	1400	1900	191	5	190	276	260	3.0	22.800
* 23232 EK	AH3232G	2.03	3.02	1.98	1200	1600	189	6	186	276	259	3.0	28.710
* 22332 EK	AH2332G	2.03	3.02	1.98	1100	1400	207	6	205	323	296	4.0	50.000
* 23034 EK	AH3034	3.07	4.57	3.00	1600	2000	194	5	190	249	238	2.1	13.000
* 24034 EK30	AH34034	2.12	3.15	2.07	1100	1400	170	11	184	250	233	2.1	17.400
* 23134 EK	AH3134G	2.39	3.56	2.34	1300	1700	204	5	195	268	250	2.1	21.550
* 24134 EK30	AH24134	1.82	2.72	1.79	850	1100	196	11	189	270	245	2.1	25.900
* 22234 EK	AH3134G	2.60	3.87	2.54	1300	1700	204	5	201	293	277	4.0	28.000
* 23234 VK	AH3234G	2.13	3.17	2.08	1000	1300	203	6	199	293	264	4.0	36.100
* 22334 EK	AH2334G	2.09	3.11	2.04	1000	1200	214	6	223	343	313	4.0	59.000
* 23036 EK	AH3036	2.95	4.40	2.89	1400	1900	207	6	201	270	255	2.1	16.900
* 24036 EK30	AH24036	2.03	3.02	1.98	1000	1300	195	11	198	270	250	2.1	22.000
* 23136 EK	AH3136G	2.32	3.45	2.26	1200	1600	208	6	205	286	267	3.0	27.210
* 24136 EK30	AH24136	1.78	2.65	1.74	600	800	170	11	200	286	261	3.0	33.000
* 22236 EK	AH2236G	2.74	4.08	2.68	1300	1700	203	6	209	303	287	4.0	28.700
* 23236 VK	AH3236G	2.17	3.23	2.12	1000	1300	213	6	210	303	274	4.0	39.600
* 22336 VK	AH2336G	2.15	3.20	2.10	850	1100	226	6	223	363	313	4.0	66.300

** These are the speed limits according to the SNR concept (see pages 85 to 87).



Double-row spherical roller bearings (continued)

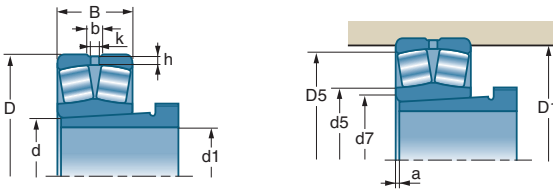

d1		Sleeves	d	D	B	b	k	h			e
mm	References		mm	mm	mm	mm	mm	mm	10°N	10°N	
180	* 23038 EK	AH3038G	190	290	75	13.2	6.0	5.1	1080.00	1570.00	0.22
	* 24038 EK30	AH24038	190	290	100	11.6	5.0	5.1	1240.00	1800.00	0.31
	23138 VK	AH3138G	190	320	104	20.0	7.5	7.0	1180.00	1950.00	0.29
	* 24138 EK30	AH24138	190	320	128	14.2	6.0	7.0	1760.00	2480.00	0.38
	* 22238 EK	AH2238G	190	340	92	19.6	9.0	8.5	1540.00	1870.00	0.25
	23238 VK	AH3238G	190	340	120	16.7	9.0	8.5	1480.00	2370.00	0.32
	22338 VK	AH2338G	190	400	132	22.3	9.0	10.0	1830.00	2650.00	0.33
190	* 23040 EK	AH3040G	200	310	82	0.0	7.0	5.1	1250.00	1790.00	0.23
	* 24040 EK30	AH24040	200	310	109	12.7	6.0	5.1	1440.00	2120.00	0.33
	23140 VK	AH3140	200	340	112	16.7	9.0	7.0	1290.00	2120.00	0.30
	* 24140 EK30	AH24140	200	340	140	17.0	8.0	7.0	2030.00	2930.00	0.39
	* 22240 EK	AH2240	200	360	98	20.0	10.0	8.5	1720.00	2100.00	0.25
	23240 VK	AH3240	200	360	128	16.7	9.0	8.5	1630.00	2700.00	0.32
	22340 VK	AH2340	200	420	138	22.3	12.0	10.0	1830.00	2650.00	0.31
200	* 23044 EK	AOH3044G	220	340	90	15.4	7.0	6.2	1450.00	2110.00	0.23
	24044 VK30	AOH24044	220	340	118	12.2	6.3	6.2	1400.00	2700.00	0.34
	23144 VK	AOH3144	220	370	120	20.7	9.0	8.5	1540.00	2600.00	0.29
	24144 VK30	AOH24144	220	370	150	11.1	6.3	8.5	1980.00	3660.00	0.38
	* 22244 EK	AOH2244	220	400	108	20.6	11.0	8.5	2100.00	2690.00	0.25
	* 23244 EK	AOH2344	220	400	144	20.0	10.0	8.5	2750.00	3830.00	0.34
	22344 VK	AOH2344	220	460	145	22.3	12.0	10.0	2110.00	3150.00	0.30
220	23048 VK	AOH3048	240	360	92	13.9	7.5	6.2	1090.00	2050.00	0.24
	24048 VK30	AOH24048	240	360	118	12.2	6.3	6.2	1500.00	2900.00	0.32
	23148 VK	AOH3148	240	400	128	16.7	9.0	8.5	1720.00	2950.00	0.29
	24148 VK30	AOH24148	240	400	160	11.1	6.3	8.5	2270.00	4240.00	0.38
	22248 VK	AOH3148	240	440	120	22.3	12.0	8.5	1920.00	2470.00	0.29
	23248 VK	AOH2348	240	440	160	22.3	12.0	8.5	2420.00	3950.00	0.33
	22348 VK	AOH2348	240	500	155	22.3	12.0	10.0	2450.00	3700.00	0.29
240	23052 VK	AOH3052	260	400	104	16.7	9.0	7.3	1490.00	2430.00	0.25
	24052 VK30	AOH24052G	260	400	140	12.2	6.3	7.3	1900.00	3800.00	0.35
	23152 VK	AOH3152G	260	440	144	16.7	9.0	8.5	2140.00	3750.00	0.29
	24152 VK30	AOH24152	260	440	180	13.9	6.3	8.5	2770.00	5290.00	0.39
	23252 VK	AOH2352G	260	480	174	22.3	12.0	13.0	2700.00	4450.00	0.33
260	23056 VK	AOH3056G	280	420	106	16.7	9.0	7.3	1500.00	2850.00	0.23
	24056 VK30	AOH24056G	280	420	140	12.2	6.3	7.3	2000.00	4000.00	0.25
	23156 VK	AOH3156G	280	460	146	16.7	9.0	10.0	2240.00	4050.00	0.28

* indicate bearings of the range SNR PREMIER

■ Spherical double-row rollers with tapered bore and withdrawal sleeves (continued)



References	Sleeves	Y		Yo	rpm**		D7 max	a	d5	D1 max	D5	r1 max	kg
		Fa — ≤ e Fr	Fa — > e Fr		rpm**	rpm**							
* 23038 EK	AH3038G	3.01	4.48	2.94	1400	1800	214	6	213	279	266	2.1	17.200
* 24038 EK30	AH24038	2.15	3.20	2.10	1000	1300		13	206	279	261	2.1	22.240
23138 VK	AH3138G	2.33	3.47	2.28	1000	1300	221	6	218	306	278	3.0	33.500
* 24138 EK30	AH24138	1.76	2.62	1.72	550	750	212	13	213	308	289	3.0	41.000
* 22238 EK	AH2238G	2.74	4.08	2.68	1200	1600	215	7	222	323	305	4.0	35.000
23238 VK	AH3238G	2.13	3.17	2.08	950	1200	225	7	223	323	290	4.0	47.400
22338 VK	AH2338G	1.88	2.80	1.84	800	1100	241	7	240	380	332	5.0	75.000
* 23040 EK	AH3040G	2.95	4.40	2.89	1300	1700	227	6	223	300	283	2.1	22.560
* 24040 EK30	AH24040	2.06	3.06	2.01	950	1200		13	219	299	278	2.1	29.710
23140 VK	AH3140	2.28	3.39	2.23	950	1200	233	6	230	326	294	3.0	41.400
* 24140 EK30	AH24140	1.74	2.59	1.70	550	700	228	13	225	326	292	3.0	52.600
* 22240 EK	AH2240	2.74	4.08	2.68	1100	1500	227	7	234	343	323	4.0	42.000
23240 VK	AH3240	2.12	3.16	2.08	900	1100	237	7	238	343	307	4.0	58.100
22340 VK	AH2340	2.17	3.24	2.12	750	1000	247	7	302	400	346	5.0	97.000
* 23044 EK	AOH3044G	2.95	4.40	2.89	1200	1500	249	6	246	327	310	3.0	31.450
24044 VK30	AOH24044	1.96	2.92	1.92	850	1100	245	14	246	328	302	3.0	38.200
23144 VK	AOH3144	2.31	3.44	2.26	900	1100	256	6	253	353	321	4.0	53.000
24144 VK30	AOH24144	1.77	2.63	1.73	500	670	250	14	253	353	316	4.0	66.100
* 22244 EK	AOH2244	2.74	4.08	2.68	1000	1300	254	8	264	383	358	4.0	59.000
* 23244 EK	AOH2344	2.00	2.98	1.96	850	1100	259	8	261	383	350	4.0	74.800
22344 VK	AOH2344	2.23	3.32	2.18	700	950	273	8	332	440	380	5.0	122.000
23048 VK	AOH3048	2.84	4.23	2.78	1000	1300	267	7	270	348	324	3.0	32.700
24048 VK30	AOH24048	2.10	3.13	2.06	800	1000	265	15	264	347	319	3.0	41.500
23148 VK	AOH3148	2.35	3.50	2.30	800	1000	277	7	276	381	348	4.0	65.500
24148 VK30	AOH24148	1.79	2.67	1.75	460	620	273	15	270	383	342	4.0	81.300
22248 VK	AOH3148	2.30	3.42	2.25	730	950	284	8	333	423	377	4.0	83.500
23248 VK	AOH2348	2.07	3.07	2.02	750	950	281	8	285	423	372	4.0	112.000
22348 VK	AOH2348	2.29	3.42	2.24	660	850	297	8	362	480	414	5.0	156.000
23052 VK	AOH3052	2.73	4.07	2.67	950	1200	292	7	284	385	364	4.0	45.800
24052 VK30	AOH24052G	1.94	2.88	1.89	750	950	293	16	291	385	354	4.0	66.500
23152 VK	AOH3152G	2.29	3.42	2.24	750	950	302	7	302	420	380	4.0	91.600
24152 VK30	AOH24152	1.75	2.60	1.71	420	560	295	16	294	423	373	4.0	113.000
23252 VK	AOH2352G	2.06	3.07	2.02	690	850	460	8	364	460	405	5.0	142.000
23056 VK	AOH3056G	3.00	4.46	2.93	900	1100	310	7	311	405	379	4.0	53.310
24056 VK30	AOH24056G	2.74	4.08	2.68	700	900	310	17	318	405	375	4.0	70.500
23156 VK	AOH3156G	2.37	3.53	2.32	700	900	314	8	322	414	401	5.0	98.000

** These are the speed limits according to the SNR concept (see pages 85 to 87).



Double-row spherical roller bearings (continued)

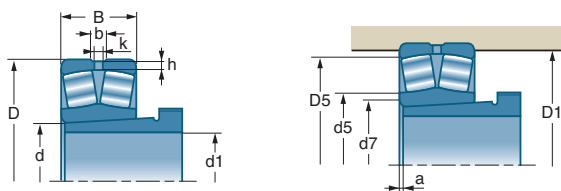



d1		Sleeves	d	D	B	b	k	h			e
mm	References		mm	mm	mm	mm	mm	mm	10°N	10°N	
260	24156 VK30	A0H24156	280	460	180	13.9	6.3	10.0	3390.00	5600.00	0.37
	23256 VK	A0H2356G	280	500	176	22.3	12.0	10.0	2900.00	4900.00	0.32
	22356 VK	A0H2356G	280	580	175	22.3	12.0	13.0	3429.00	5182.00	0.31
280	23060 VK	A0H3060	300	460	118	16.7	9.0	7.3	1820.00	3350.00	0.23
	24060 VK30	A0H24060	300	460	160	12.2	6.3	7.3	2500.00	5200.00	0.35
	23160 VK	A0H3160G	300	500	160	16.7	9.0	10.0	2632.00	4645.00	0.32
	24160 VK30	A0H24160	300	500	200	12.2	6.3	10.0	4070.00	6840.00	0.40
	23260 VK	A0H3260G	300	540	192	22.3	12.0	13.0	3350.00	5600.00	0.32
300	23064 VK	A0H3064G	320	480	121	16.7	9.0	7.3	1920.00	3600.00	0.22
	23164 VK	A0H3164G	320	540	176	22.3	12.0	10.0	3050.00	5500.00	0.29
320	23068 VK	A0H3068G	340	520	133	22.3	12.0	8.0	2270.00	4200.00	0.23
	23168 VK	A0H3168G	340	580	190	22.3	12.0	10.0	3500.00	6100.00	0.29
340	23072 VK	A0H3072G	360	540	134	22.3	12.0	9.0	2390.00	4550.00	0.22
	23172 VK	A0H3172	360	600	192	22.3	12.0	10.0	3681.00	6683.00	0.29
360	23076 VK	A0H3076G	380	560	135	22.3	12.0	9.0	2420.00	4700.00	0.21
380	23080 VK	A0H3080G	400	600	148	22.3	12.0	10.0	2926.00	5648.00	0.22

* indicate bearings of the range SNR PREMIER

■ Spherical double-row rollers with tapered bore and withdrawal sleeves (continued)

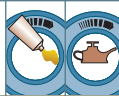

	Sleeves	Y		Yo			d7 max	a ≈	d5 ≈	D1 max	D5 ≈	r1 max	
		Fa ← ≤ e Fr	Fa → > e Fr		rpm**	rpm**							
References							mm	mm	mm	mm	mm	mm	kg
24156 VK30	A0H24156	1.85	2.75	1.80	400	530	310	17	315	440	396	5.0	121.000
23256 VK	A0H2356G	2.12	3.16	2.08	650	800	239	8	327	480	346	5.0	152.000
22356 VK	A0H2356G	2.17	3.24	2.12	950	670	345	8	437	554	493	6.0	230.000
23060 VK	A0H3060	2.95	4.40	2.89	800	1000	336	8	376	445	414	4.0	73.100
24060 VK30	A0H24060	1.95	2.90	1.91	650	800	337	18	343	445	407	4.0	99.400
23160 VK	A0H3160G	2.10	3.00	2.00	670	850	347	8	346	480	435	5.0	129.700
24160 VK30	A0H24160	1.67	2.49	1.63	370	490	346	18	340	480	429	5.0	160.000
23260 VK	A0H3260G	2.12	3.15	2.07	610	750	353	8	415	520	459	5.0	195.000
23064 VK	A0H3064G	3.01	4.49	2.95	750	1000	357	8	355	465	433	4.0	79.100
23164 VK	A0H3164G	2.31	3.44	2.26	620	800	373	8	363	520	468	5.0	168.500
23068 VK	A0H3068G	2.98	4.43	2.91	700	950	382	9	426	502	468	5.0	105.000
23168 VK	A0H3168G	2.29	3.42	2.24	580	750	395	9	455	560	501	5.0	202.200
23072 VK	A0H3072G	3.07	4.56	3.00	700	900	403	9	400	522	488	5.0	110.700
23172 VK	A0H3172	2.36	3.51	2.31	560	700	416	9	475	580	522	5.0	223.800
23076 VK	A0H3076G	3.16	4.71	3.09	670	850	422	10	466	542	508	5.0	116.200
23080 VK	A0H3080G	3.08	4.59	3.02	600	750	448	10	497	582	542	5.0	155.000

** These are the speed limits according to the SNR concept (see pages 85 to 87).



Double-row spherical roller bearings (continued)

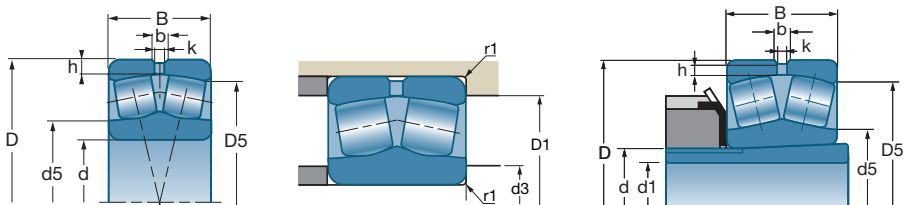

d		Sleeves H	Sleeves AH	D	B	b	k	h			e
mm	References			mm	mm	mm	mm	mm	10°N	10°N	
40	* 22308 E F800	H2308	AH2308	90	33	5.9	3	4.5	161	152	0.36
	* 22308 EK F800			90	33	5.9	3	4.5	161	152	0.36
45	* 22309 E F800	H2309	AH2309	100	36	6.4	3	4.5	196	187	0.36
	* 22309 EK F800			100	36	6.4	3	4.5	196	187	0.36
50	* 22310 E F800	H2310	AHX2310	110	40	7.4	3.5	5.5	237	232	0.36
	* 22310 EK F800			110	40	7.4	3.5	5.5	237	232	0.36
55	* 22311 E F800	H2311	AHX2311	120	43	7.8	3.5	5.5	282	274	0.36
	* 22311 EK F800			120	43	7.8	3.5	5.5	282	274	0.36
60	* 22312 E F800	H2312	AHX2312	130	46	8.7	4	6	323	319	0.35
	* 22312 EK F800			130	46	8.7	4	6	323	319	0.35
65	* 22313 E F800	H2313	AH2313G	140	48	9.2	4	6	351	343	0.33
	* 22313 EK F800			140	48	9.2	4	6	351	343	0.33
70	* 22314 E F800	H2314	AHX2314G	150	51	10.4	5	6	400	396	0.34
	* 22314 EK F800			150	51	10.4	5	6	400	396	0.34
75	* 22315 E F800	H2315	AHX2315G	160	55	10.3	5	6	467	467	0.34
	* 22315 EK F800			160	55	10.3	5	6	467	467	0.34
80	* 22316 E F800	H2316	AHX2316	170	58	10.4	5	6	515	522	0.34
	* 22316 EK F800			170	58	10.4	5	6	515	522	0.34
85	* 22317 E F800	H2317	AHX2317	180	60	11	5	7	570	604	0.32
	* 22317 EK F800			180	60	11	5	7	570	604	0.32
90	* 22318 E F800	H2318	AHX2318	190	64	11.56	5	7	636	652	0.33
	* 22318 EK F800			190	64	11.56	5	7	636	652	0.33
95	* 22319 E F800	H2319	AHX2319	200	67	12.15	6	7	696	751	0.32
	* 22319 EK F800			200	67	12.15	6	7	696	751	0.32
100	* 22320 E F800	H2320	AHX2320	215	73	13.3	6	7	787	844	0.34
	* 22320 EK F800			215	73	13.3	6	7	787	844	0.34
110	* 22322 E F800	H2322	AHX2322G	240	80	15.6	7	7	928	972	0.31
	* 22322 EK F800			240	80	15.6	7	7	928	972	0.31

* indicate bearings of the range SNR PREMIER

■ Spherical double-row rollers with tapered bore for high vibration applications

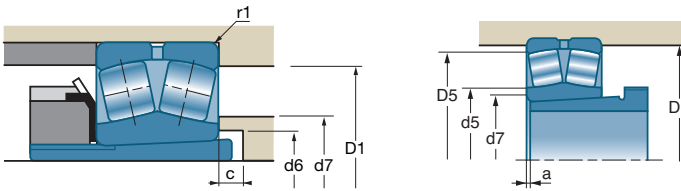

References	Y		Yo	rpm**		c	d5	d3	d6	d7	a	D1	D5	r1	kg
	Fa ≤ e Fr	Fa > e Fr		rpm**	rpm**										
* 22308 E F800	1.87	2.79	1.83	4100	5300		53	49				81	78	1.5	1.021
* 22308 EK F800	1.87	2.79	1.83	4100	5300	5	53		45	50	3	83		1.5	1.000
* 22309 E F800	1.9	2.83	1.86	3700	4800		59	54				91	87	1.5	1.369
* 22309 EK F800	1.9	2.83	1.86	3700	4800	5	59		50	56	3	93		1.5	1.380
* 22310 E F800	1.87	2.79	1.83	3400	4400		65	61				99	95	2	1.834
* 22310 EK F800	1.87	2.79	1.83	3400	4400	5	65		56	61	3	101		2	1.810
* 22311 E F800	1.87	2.79	1.83	3100	4000		71	66				109	104	2	2.340
* 22311 EK F800	1.87	2.79	1.83	3100	4000	6	71		61	66	3	111		2	2.310
* 22312 E F800	1.95	2.9	1.91	2900	3700		77	72				118	113	2.1	2.892
* 22312 EK F800	1.95	2.9	1.91	2900	3700	6	77		66	72	3	120		2.1	2.880
* 22313 E F800	2.06	3.06	2.01	2700	3400		83	77				128	122	2.1	3.493
* 22313 EK F800	2.06	3.06	2.01	2700	3400	6	83		72	78	3	130		2.1	3.480
* 22314 E F800	2	2.98	1.96	2500	3200		89	82				138	131	2.1	4.274
* 22314 EK F800	2	2.98	1.96	2500	3200	6	89		77	83	4	140		2.1	4.200
* 22315 E F800	2	2.98	1.96	2300	3000		95	87				148	139	2.1	5.210
* 22315 EK F800	2	2.98	1.96	2300	3000	6	95		82	89	4	150		2.1	5.100
* 22316 E F800	2	2.98	1.96	2200	2800		101	92				158	148	2.1	6.200
* 22316 EK F800	2	2.98	1.96	2200	2800	6	101		88	95	4	160		2.1	6.180
* 22317 E F800	2.09	3.11	2.04	2000	2600		110	99				166	157	3	7.160
* 22317 EK F800	2.09	3.11	2.04	2000	2600	7	110		94	103	4	166		3	7.160
* 22318 E F800	2.06	3.06	2.01	1900	2500		113	104					176	3	8.501
* 22318 EK F800	2.06	3.06	2.01	1900	2500	7	113		100	114	4	176		3	8.400
* 22319 E F800	2.09	3.11	2.04	1800	2300		122	111				186	174	3	10.000
* 22319 EK F800	2.09	3.11	2.04	1800	2300	7	122		105	122	4	186		3	10.000
* 22320 E F800	1.98	2.94	1.93	1700	2200		129	114				201	187	3	12.776
* 22320 EK F800	1.98	2.94	1.93	1700	2200	7	129		110	129	4	201		3	12.700
* 22322 E F800	2.09	3.11	2.04	1600	2000		142	124				226	209	3	17.406
* 22322 EK F800	2.09	3.11	2.04	1600	2000	7	142		121	133	4	226		3	17.850

** These are the speed limits according to the SNR concept (see pages 85 to 87).



Double-row spherical roller bearings (continued)

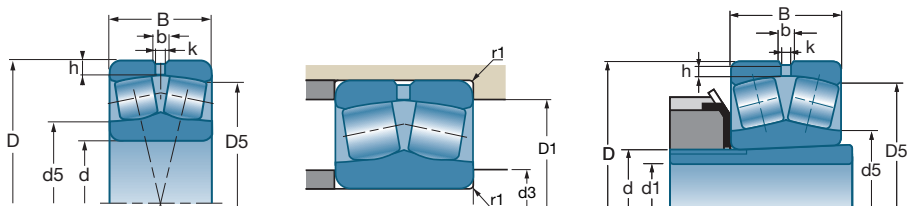



d	References	Sleeves H	Sleeves AH	D	B	b	k	h	C		e
									10°N	C ₀	
mm				mm	mm	mm	mm	mm	10°N	10°N	
120	* 22324 E F800	H2324	AHX2324G	260	86	18	8	7	1110	1280	0.32
	* 22324 EK F800			260	86	18	8	7	1110	1280	0.32
130	* 22326 E F800	H2326	AHX2326G	280	93	18.9	9	8.5	1260	1400	0.33
	* 22326 EK F800			280	93	18.9	9	8.5	1260	1400	0.33
140	* 22328 E F800	H2328	AHX2328G	300	102	18.9	9	8.5	1470	1720	0.33
	* 22328 EK F800			300	102	18.9	9	8.5	1470	1720	0.33
150	* 22330 E F800	H2330	AHX2330G	320	108	19.9	9	8.5	1660	1890	0.34
	* 22330 EK F800			320	108	19.9	9	8.5	1660	1890	0.34
160	* 22332 E F800	H2332	AH2332G	340	114	20.3	10	8.5	1850	2210	0.33
	* 22332 EK F800			340	114	20.3	10	8.5	1850	2210	0.33
170	* 22334 E F800	H2334	AH2334G	360	120	20.25	10	8.5	2100	2630	0.32
	* 22334 EK F800			360	120	20.25	10	8.5	2100	2630	0.32

* indicate bearings of the range SNR PREMIER

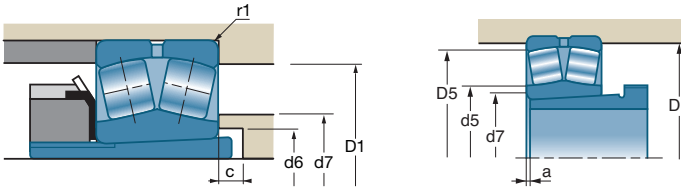
■ Spherical double-row rollers with tapered bore for high vibration applications (*continued*)

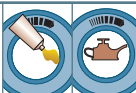

	Y		Yo			c	d5	d3	d6	d7	a	D1	D5	r1	
	$\frac{Fa}{Fr} \leq e$	$\frac{Fa}{Fr} > e$		mm	mm		mm	mm	mm	mm	mm	mm	mm	mm	
References				rpm**	rpm**	mm	mm	mm	mm	mm	mm	mm	mm	mm	kg
* 22324 E F800	2.09	3.11	2.04	1400	1800		157	134				246	225	3	22.600
* 22324 EK F800	2.09	3.11	2.04	1400	1800	7	157		131	157	4	246		3	22.300
* 22326 E F800	2.06	3.06	2.01	1300	1700		167	147				263	243	4	27.900
* 22326 EK F800	2.06	3.06	2.01	1300	1700	8	167		142	167	4	263		4	27.600
* 22328 E F800	2.03	3.02	1.98	1200	1600		182	157				283	261	4	34.903
* 22328 EK F800	2.03	3.02	1.98	1200	1600	8	182		152	182	5	283		4	34.800
* 22330 E F800	2	2.98	1.96	1200	1500		192	167				303	279	4	41.960
* 22330 EK F800	2	2.98	1.96	1200	1500	8	192		163	192	5	303		4	42.300
* 22332 E F800	2.03	3.02	1.98	1100	1400		207	177				323	296	4	50.700
* 22332 EK F800	2.03	3.02	1.98	1100	1400	8	207		174	207	6	323		4	50.300
* 22334 E F800	2.09	3.11	2.04	1000	1200		223	187				343	313	4	59.000
* 22334 EK F800	2.09	3.11	2.04	1000	1200	8	223		185	214	6	343		4	57.500

** These are the speed limits according to the SNR concept (see pages 85 to 87).



Thrust bearings

Thrust ball bearings	378
■ Definition and capabilities	378
■ Series	378
■ Tolerances	379
■ Design criteria	379
■ Installation/Assembly criteria	379
■ Characteristics	380
<i>Thrust ball bearings with simple effect</i>	380
Spherical roller thrust bearings	384
■ Definition and capabilities	384
■ Series	385
■ Tolerances	385
■ Design criteria	385
■ Installation/Assembly criteria	385
■ Characteristics	386
<i>Spherical roller thrust bearings</i>	386



Thrust ball bearings

Definition and capabilities

→ Definition

Thrust ball bearings have a contact angle of 90° and are designed to withstand axial loads only. They must therefore often be associated with a radial bearing.

Single-direction ball thrust bearings withstand the axial load of a shaft in only one direction. Thrust bearings are made of detachable elements: shaft-ring, housing-ring, ball-cage assembly.

■ Cages

Thrust bearings are equipped with a pressed steel cage.

→ Capabilities

■ Loads and speeds

Can withstand axial loads only in one direction, and low speeds.

■ Misalignment

As the performance of a thrust bearing is related to the distribution of the load over the entire circumference, it is important to have virtually no misalignment between the shaft-ring and the housing-ring (misalignment angle less than 0.03°).

Series

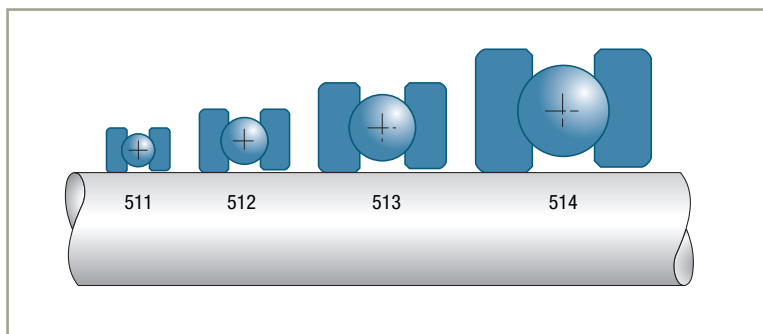

Tolerances

In accordance with ISO 199 Standard, normal tolerance class.

Design criteria

■ Bearing life

■ Minimum dynamic axial load

To compensate for the effects of the centrifugal force being exerted on the balls, it is necessary to permanently exert on the thrusts an axial loading F_a whose minimal value F_{am} (in NR) is determined by the formula:

$$F_{am} = 10^{-14} (N \cdot C_0)^2$$

■ Maximum static axial capacity

This is defined by the basic static capacity C_0 .

Installation/Assembly criteria

■ Fitting and adjustment

As the elements are detachable they are interchangeable. The shaftring is mounted on its seat with an interference fit. The housing-ring must be free to centre itself. To ease the correct position of the thrust bearing when fitting, the housing-ring has a bore diameter (d_5) greater than that of the shaft-ring (d). If the axial load of the non-loaded thrust bearing is insufficient, a pre-load must be applied using springs to reach the minimum dynamic axial load defined above.

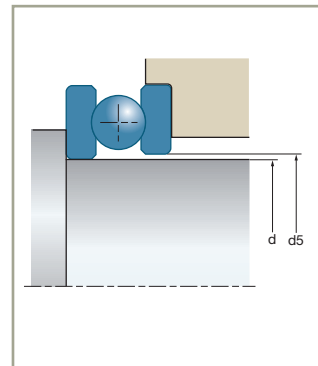

Thrust ball bearings (continued)

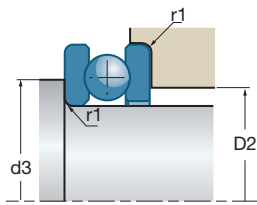
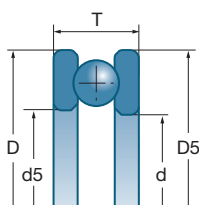

d		d5	D	D5	T		
						10°N	10°N
mm	References	mm	mm	mm	mm	10°N	10°N
10	51100	11	24	24	9	10.00	14.00
12	51101	13	26	26	9	10.30	15.40
15	51102	16	28	28	9	10.50	16.80
	51202	17	32	32	12	15.70	24.40
17	51103	18	30	30	9	11.30	19.60
	51203	19	35	35	12	16.20	26.60
20	51104	21	35	35	10	15.00	26.60
	51204	22	40	40	14	22.30	37.70
25	51105	26	42	42	11	18.10	35.50
	51205	27	47	47	15	27.80	50.50
	51305	27	52	52	18	35.70	61.50
	51405	27	60	60	24	55.50	89.40
30	51106	32	47	47	11	18.80	39.90
	51206	32	52	52	16	29.40	58.20
	51306	32	60	60	21	42.70	78.70
	51406	32	70	70	28	72.70	126.00
35	51107	37	52	52	12	20.10	46.60
	51207	37	62	62	18	39.10	78.20
	51307	37	68	68	24	55.50	105.00
	51407	37	80	80	32	86.90	155.00
40	51108	42	60	60	13	26.90	62.90
	51208	42	68	68	19	44.00	92.40
	51308	42	78	78	26	69.30	135.00
45	51109	47	65	65	14	27.90	69.20
	51209	47	73	73	20	46.50	105.00
	51309	47	85	85	28	80.00	164.00
	51409	47	100	100	39	130.00	243.00
50	51110	52	70	70	14	28.80	75.50
	51210	52	78	78	22	47.20	111.00
55	51111	57	78	78	16	34.80	93.20
	51211	57	90	90	25	69.40	159.00
	51311	57	105	105	35	119.00	246.00

Characteristics

■ Thrust ball bearings with simple effect

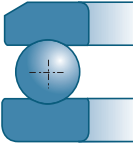

References	rpm*	rpm*	d3 min mm	D2 max mm	r1 max mm	kg
51100	7900	10600	18	16	0.30	0.021
51101	7500	10000	20	18	0.30	0.023
51102 51202	7100 6000	9400 7900	23 25	20 22	0.30 0.60	0.025 0.042
51103 51203	7100 5600	9400 7500	25 28	22 24	0.30 0.60	0.025 0.050
51104 51204	6300 5000	8400 6700	29 32	26 28	0.30 0.60	0.038 0.078
51105 51205 51305 51405	5300 4500 3800 3200	7100 6000 5000 4200	35 38 41 46	32 34 36 39	0.60 0.60 1.00 1.00	0.058 0.110 0.167 0.340
51106 51206 51306 51406	5000 4000 3300 2700	6700 5300 4500 3500	40 43 48 54	37 39 42 46	0.60 0.60 1.00 1.00	0.065 0.133 0.270 0.530
51107 51207 51307 51407	4700 3500 2800 2200	6300 4700 3800 3000	45 51 55 62	42 46 48 53	0.60 1.00 1.00 1.10	0.081 0.203 0.377 0.790
51108 51208 51308	4200 3200 2700	5600 4200 3500	52 57 63	48 51 55	0.60 1.00 1.00	0.110 0.260 0.540
51109 51209 51309 51409	4000 3000 2400 1900	5300 4000 3200 2500	57 62 69 78	53 56 61 67	0.60 1.00 1.00 1.10	0.128 0.283 0.662 1.450
51110 51210	3800 2800	5000 3800	62 67	58 61	0.60 1.00	0.139 0.380
51111 51211 51311	3300 2500 1900	4500 3300 2500	69 76 85	64 69 75	0.60 1.00 1.10	0.220 0.590 1.350

* These are the speed limits according to the SNR concept (see pages 85 to 87).



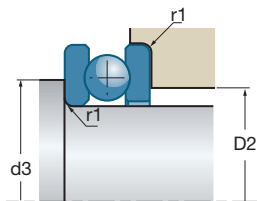
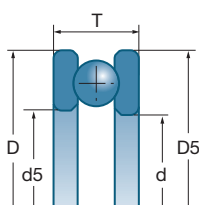

Thrust ball bearings (continued)

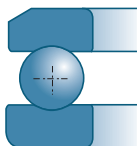

d		d5	D	D5	T		
mm	References	mm	mm	mm	mm	10°N	10°N
60	51112	62	85	85	17	41.40	113.00
	51312	62	110	110	35	124.00	270.00
65	51213	67	100	100	27	74.90	189.00
	51313	67	115	115	36	128.00	287.00
70	51114	72	95	95	18	43.10	127.00
	51214	72	105	105	27	76.10	199.00
75	51115	77	100	100	19	44.50	136.00
	51215	77	110	110	27	77.30	209.00
80	51116	82	105	105	19	44.60	141.00
	51216	82	115	115	28	78.50	219.00
	51416	83	170	170	68	317.00	751.00
85	51117	87	110	110	19	46.00	150.00
	51217	88	125	125	31	95.40	264.00
90	51118	92	120	120	22	59.70	190.00
100	51120	102	135	135	25	85.10	268.00
110	51122	112	145	145	25	87.30	288.00
120	51124	122	155	155	25	88.90	308.00
130	51126	132	170	170	30	119.00	406.00
150	51130	152	190	188	31	123.00	448.00
160	51132	162	200	198	31	125.00	476.00

■ Thrust ball bearings with simple effect (*continued*)



 References	 rpm*	 rpm*	d3 min mm	D2 max mm	r1 max mm	 kg
51112	3200	4200	75	70	1.00	0.257
51312	1900	2500	90	80	1.10	1.450
51213	2400	3200	86	79	1.00	0.729
51313	1800	2400	95	85	1.10	1.550
51114	2800	3800	85	80	1.00	0.354
51214	2200	3000	91	84	1.00	0.783
51115	2700	3500	90	85	1.00	0.398
51215	2200	3000	96	89	1.00	0.827
51116	2700	3500	95	90	1.00	0.430
51216	2000	2700	101	94	1.00	0.908
51416	890	1200	133	116	2.10	7.300
51117	2700	3500	100	95	1.00	0.442
51217	2000	2700	109	101	1.00	1.300
51118	2000	2700	108	102	1.00	0.598
51120	2000	2700	121	114	1.00	0.974
51122	1900	2500	131	124	1.00	1.060
51124	1600	2100	141	134	1.00	1.140
51126	1400	1900	154	146	1.00	1.740
51130	1300	1800	174	166	1.00	2.000
51132	1300	1800	184	176	1.00	2.100

* These are the speed limits according to the SNR concept (see pages 85 to 87).

Spherical roller thrust bearings

Definition and capabilities

→ Definition

Spherical roller thrust bearings are made up of two detachable components: the shaft ring on which are mounted the cage and the spherical-tapered rolling elements, and the housing ring whose spherical raceway enables the bearing to swivel.

SNR Spherical roller thrust bearings are equipped with a solid brass cage or sheet steel* centred (optimised E series) by a tube crimped in the bore of the shaft-washer. Eventually, SNR thrust bearings will be exclusively equipped with a sheet steel cage optimised E version.

When they are associated with a radial bearing (usually a double-row spherical roller bearing), their point of load application A must coincide with that of the bearing to permit self-alignment.

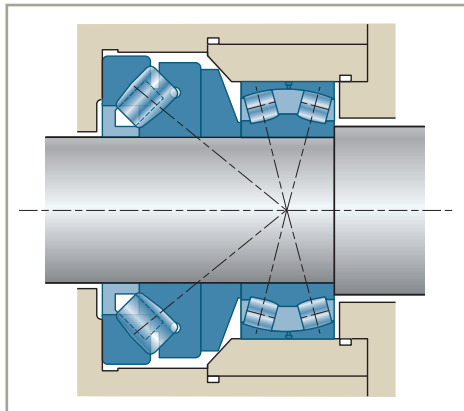

* Thrust bearings with metal sheet cage are interchangeable with competitors' designs.

→ Capabilities

■ Loads and speeds

- Very high axial load capacity
- Possibility of withstanding relatively high radial loads, of about half the value of the axial load, thanks to a high contact angle of about 50°
- Low speeds

■ Misalignment

The self-alignment possibility provided by the spherical raceway of the housing-ring enables it to accept misalignment of about 3°. The misalignment may be limited, depending on the sealing system used.

Bearing type	Permitted tilting
292...	2°
293...	2°30'
294...	3°

Series

Solid cage

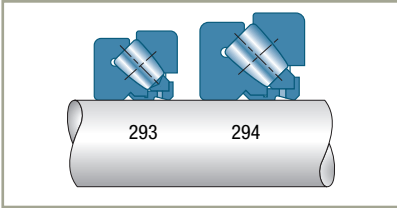

Sheet steel cage

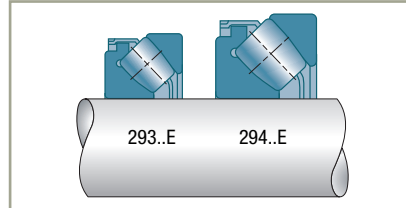

Tolerances

Spherical roller thrust bearings are manufactured in standard precision to the tolerances fixed for the ball thrust bearings (ISO 199).

Design criteria

- Bearing life
- Minimum axial load

To ensure smooth and slip-free rotation of the rollers, the thrust bearings must be subjected to a permanent minimum axial load F_{am} (in N) of:

$$F_{am} = 2 \cdot 10^{-16} (N \cdot C_0)^2$$

If the operating axial load is less than the minimum axial load, pre-load the thrust bearing with springs.

Installation/Assembly criteria

The elements are detachable and interchangeable.

The shaft-ring is interference-fitted on its seat. The other ring is centred in its housing if the thrust bearing is not associated with another radial bearing.

Conversely, if centring is secured by a radial bearing, the thrust bearing housing-ring must be free to centre itself.

- Lubrication

Spherical roller thrust bearings usually have to work under very high loads needing oil lubrication.

In view of the internal design of this type of thrust bearing, lubrication with grease can only be considered for low speeds of rotation and moderate loads.

- Maximum permissible axial load on the cage centring tube

In certain assemblies, because the mild-steel cage centring tube acts as a seat for a spacer-type washer, it must be checked that the axial thrust load does not exceed the values indicated below:

- 0.4 C_0 for thrust bearings 29300
- 0.5 C_0 for thrust bearings 29400

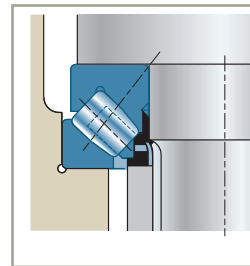

Spherical roller thrust bearings (continued)

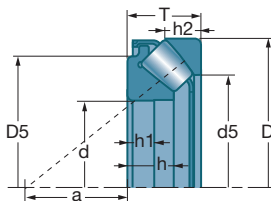
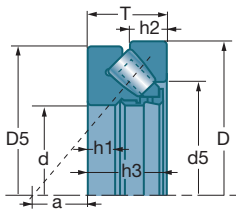

d		D	T	D5	d5	h	h1	h2	h3	a
mm	Références	mm	mm	mm	mm	mm	mm	mm	mm	mm
60	29412 E	130	42	88,0	112,3	27,0	15,0	20,5		38,0
65	29413 E	140	45	96,5	122,8	29,5	16,0	22,0		42,0
70	29414 E	150	48	105,0	131,6	31,0	17,0	23,0		44,0
75	29415 E	160	51	109,0	141,8	33,5	18,0	24,0		47,0
80	29416 E	170	54	117,0	150,8	35,0	19,0	24,0		50,0
85	29417 E	180	58	123,0	160,6	37,0	19,0	28,0		54,0
90	29418 E	190	60	130,0	170,8	39,0	22,0	29,0		56,0
100	29320 E	170	42	128,0	149,9	26,2	15,0	20,5		58,0
	29420 E	210	67	144,5	189,8	43,0	24,0	32,0		62,0
110	29322	190	48	143,0	176,0		16,0	23,0	45,5	64,0
	29322 E	190	48	140,5	171,0	30,3	16,0	23,0		64,0
	29422 E	230	73	159,0	211,5	47,0	27,0	35,0		69,0
120	29324	210	54	157,5	194,0		18,0	26,0	51,0	70,0
	29424 E	250	78	173,0	227,8	50,5	29,0	37,0		74,0
130	29326	225	58	170,0	205,0		19,0	28,0	55,0	76,0
	29326 E	225	58	165,7	199,7	36,7	21,0	30,1		76,0
	29426 E	270	85	188,0	245,4	54,0	31,0	41,0		81,0
140	29328	240	60	183,0	219,0		20,0	29,0	57,0	82,0
	29328 E	240	60	178,8	213,7	38,5	22,0	30,0		82,0
	29428 E	280	85	196,5	254,0	54,0	32,0	41,0		86,0
150	29330	250	60	193,0	229,0		20,0	29,0	57,0	87,0
	29330 E	250	60	189,6	222,5	38,0	22,0	28,0		87,0
	29430 E	300	90	209,5	273,0	58,0	34,0	44,0		92,0
160	29332	270	67	207,0	248,0		23,0	32,0	64,0	92,0
	29332 E	270	67	202,3	243,6	42,0	24,0	33,0		92,0
	29432	320	95	226,0	306,0		34,0	45,0	91,0	99,0

Characteristics

■ Spherical roller thrust bearings

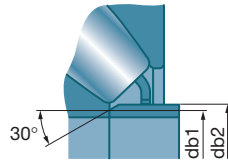
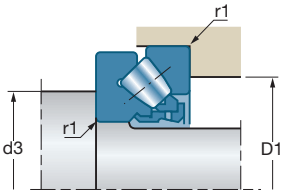

References	$10^6 N$	$10^6 N$	rpm*	d_3 min mm	D_1 max mm	r_1 max mm	db_1 max mm	db_2 max mm	kg
29412 E	335	951	2500	90	107	1,5	67	67	2,47
29413 E	405	1157	2300	100	117	2.0	72	72	3.26
29414 E	440	1280	2200	105	125	2.0	77.5	77.5	3.98
29415 E	512	1502	2000	115	133	2.0	82.5	82.5	4.90
29416 E	607	1636	1900	120	141	2.1	88	88	5.68
29417 E	692	1945	1800	130	151	2.1	94	94	6.67
29418 E	703	2172	1700	135	158	2.1	99	99	7.77
29320 E	436	1402	2100	130	147	1.5	107	107	3.65
29420 E	865	2578	1500	150	175	3.0	110	110	10.80
29322	475	1520	1900	145	166	2.0			5.48
29322 E	570	1760	1900	145	164	2.0	113	119.5	5.40
29422 E	1022	3078	1400	165	193	3.0	120.5	129	13.50
29324	600	1960	1700	160	184	2.1			7.58
29424 E	1180	3590	1300	180	209	4.0	132	141	17.50
29326	680	2230	1600	170	198	2.1			9.30
29326 E	765	2950	1500	175	194	2.1	138	145	9.08
29426 E	1395	4300	1200	195	227	4.0	142.5	153	21.60
29328	750	2500	1500	185	211	2.1			11.00
29328 E	850	3150	1400	185	208	2.1	148	155	10.50
29428 E	1509	4686	1100	205	236	4.0	153	162	23.00
29330	770	2650	1400	195	222	2.1			11.50
29330 E	863	3230	1400	195	219	2.1	158	165	10.90
29430 E	1626	5241	1000	220	253	4.0	163	175	23.00
29332	890	3050	1300	210	239	3.0			15.20
29332 E	1040	3980	1200	210	235	3.0	169	176	14.40
29432	1510	5000	1000	230	274	5.0			37.30

* These are the speed limits according to the SNR concept (see pages 85 to 87).

Spherical roller thrust bearings (continued)

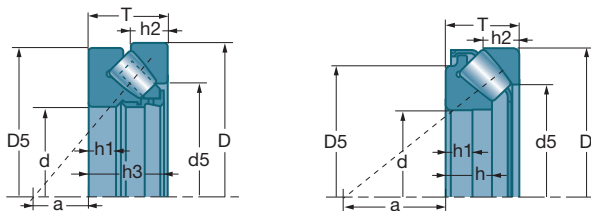

d		D	T	D5	d5	h	h1	h2	h3	a
mm	Références	mm	mm	mm	mm	mm	mm	mm	mm	mm
170	29334	280	67	215,0	258,0		23,0	32,0	64,0	96,0
	29334 E	280	67	214,6	253,6	42,2	24,0	32,0		96,0
	29434	340	103	240,0	324,0		37,0	50,0	99,0	104,0
180	29336	300	73	231,0	277,0		25,0	35,0	69,0	103,0
	29336 E	300	73	228,3	270,4	46,0	26,0	35,5		103,0
	29436	360	109	255,0	342,0		39,0	52,0	105,0	110,0
190	29338 E	320	78	239,5	284,4	49,0	28,0	36,0		110,0
	29438	380	115	270,0	360,0		41,0	55,0	111,0	117,0
200	29340 E	340	85	253,6	302,8	53,5	29,0	40,0		110,0
	29440	400	122	284,0	380,0		43,0	59,0	117,0	122,0
220	29344 E	360	85	273,0	324,4	55,0	29,0	41,0		125,0
	29444	420	122	305,0	400,0		43,0	58,0	117,0	132,0
240	29348 E	380	85	294,8	343,7	54,0	29,0	40,5		135,0
	29448	440	122	321,0	420,0		43,0	59,0	117,0	142,0
260	29352 E	420	95	320,4	380,3	61,0	32,0	46,0		148,0
	29452	480	132	346,0	460,0		48,0	64,0	127,0	154,0
280	29356 E	440	95	342,1	401,7	62,0	32,0	45,0		158,0
	29456 E	520	145	370,0	468,9	95,0	52,0	70,0		166,0
300	29360 E	480	109	366,7	431,9	70,0	36,0	51,0		168,0
	29460 E	540	145	370,0	489,2	95,0	55,0	70,5		175,0
320	29364 E	500	109	387,0	456,1	68,0	37,0	53,0		180,0
	29464 E	580	155	422,0	525,6	102,0	55,0	74,5		191,0

■ Spherical roller thrust bearings (continued)

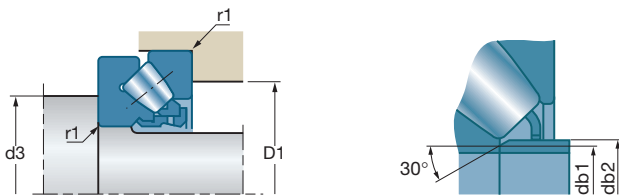

References	$10^3 N$	$10^3 N$	rpm*	d3 min mm	D1 max mm	r1 max mm	db1 max mm	db2 max mm	kg
29334	910	3200	1300	220	248	3.0			16.00
29334 E	1060	4100	1200	220	245	3.0	178	188	15.10
29434	1670	5500	950	245	291	5.0			43.70
29336	990	3500	1200	235	266	3.0			20.30
29336 E	1240	4810	1100	235	262	3.0	189	196	19.10
29436	1870	6300	900	260	307	5.0			52.00
29338 E	1437	4835	1100	250	280	4.0	200	209	23.30
29438	2030	6900	850	275	325	5.0			63.10
29340 E	1621	5475	1000	265	297	4.0	211	222	29.00
29440	2280	7800	800	290	343	5.0			69.00
29344 E	1744	6298	980	285	316	4.0	229	238	31.60
29444	2350	8300	750	310	364	6.0			74.00
29348 E	1786	6487	910	305	336	4.0	249	257	33.40
29448	2420	8700	700	330	383	6.0			83.00
29352 E	2238	8305	830	335	370	5.0	273	284	46.90
29452	2850	10300	660	360	419	6.0			105.00
29356 E	2211	8486	780	355	390	5.0	293	303	49.50
29456 E	4472	15751	620	395	446	6.0	300	319	127.00
29360 E	2650	11000	730	385	423	5.0	313	327	68.70
29460 E	4512	16458	580	415	465	6.0	319	339	133.00
29364 E	2850	10923	690	405	442	5.0	332	346	72.10
29464 E	5005	21200	540	450	500	7.5	344	366	164.00

* These are the speed limits according to the SNR concept (see pages 85 to 87).

Sleeves and accessories

Sleeves	392
■ Definition	392
■ Series	392
■ Variants	392
■ Fitting and removal criteria	392
■ Suffixes	395
■ Characteristics	396
<i>Adapter sleeves (mm)</i>	396
<i>Adapter sleeves (inch)</i>	399
<i>Withdrawal sleeves</i>	400
Nuts and washers	404
■ Clamping and withdrawal nuts	404
■ Lock-washer	404
■ Locking stirrup	404
■ Characteristics	405
<i>Locking nut</i>	405
<i>Lock-washer</i>	407
<i>Locking stirrup</i>	409
Self-locking precision nuts	410
■ Description	410
■ Series	410
■ Variants	411
■ Tolerances	411
■ Design criteria	411
■ Installation/assembly criteria	411
■ Characteristics	412
<i>Castellated, narrow series</i>	412
<i>Blind holes narrow series</i>	413
<i>Castellated, wide series</i>	414
<i>Blind holes, wide series</i>	415
<i>Snap ring</i>	416



Adapter and withdrawal sleeves

Definition

Sleeves permit bearings with a tapered bore to be tightly fitted on cylindrical shafts of broad diameter tolerances. In general, the bore taper of such bearings is 1:12. However, spherical roller bearings of the 240.. and 241.. series have a bore taper of 1:30.

Two principal types of sleeve exist:

- Adapter sleeves, which generate a tight fit by driving the bearing along the sleeve.
- Withdrawal sleeves, which generate a tight fit by driving the sleeve into the bore of the bearing. The latter permit easy dismounting of the bearing by simple application of the appropriate withdrawal nut.

The quality of bearing installation and fit is fundamental to the achievement of long and reliable service. The cleanliness and suitability of the lubrication are also important factors.

■ Shaft tolerances for use with sleeve

Diameter tolerance: quality 9 minimum

Form tolerance: quality 5 minimum

Hydraulic sleeves: with large diameter bearings it is possible to use a hydraulic sleeve that is provided with ducts and distribution grooves thereby permitting the injection of pressurized oil between the bearing and sleeve, and between the sleeve and shaft.

Series

Basic series		Hydraulic series	
Adapter sleeves	Withdrawal sleeves	Adapter sleeves	Withdrawal sleeves
H2..	AH/AHX 3..	H23..H	A0H 22..
H3..	AH/AHX 22..	H3...H	A0H 23..
H23..	AH/AHX 23..	H31..H	A0H 3...
H3...	AH/AHX 3...	H32..H	A0H 31..
H31..	AH/AHX 31..		A0H 32..
H32..	AH/AHX 32..		A0H 240..
	AH 240..		A0H 241..
	AH 241..		

Variants

The serie 2300 is available in inch.

Fitting and removal criteria

➔ Adapter sleeves

The sleeves are supplied complete with clamping nut and lock-washer. They comply with standard ISO 113/1.



Tightening the sleeves is a delicate operation, refer to the instructions to ensure satisfactory mounting.

■ Fitting

► Mechanical method (1)

Lubricate the contact surfaces: by applying oil or grease to both the sleeve thread and the face of the nut which will be in contact with the bearing.

Tighten the nut until the required fits is obtained*.

Loosen and remove the nut in order to introduce the locking washer. Tighten the nut to reestablish the contact and lock it in place by bending one tab of the locking washer.

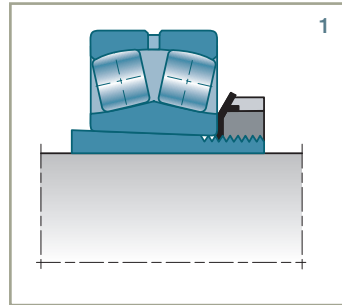

► Hydraulic method (2)

Lubricate the contact surfaces as per the mechanical method.

Screw the hydraulic nut onto the sleeve, its piston in contact with the bearing. Inject oil until the required fit is obtained*.

Remove the hydraulic nut, lock the sleeve with the locking washer.

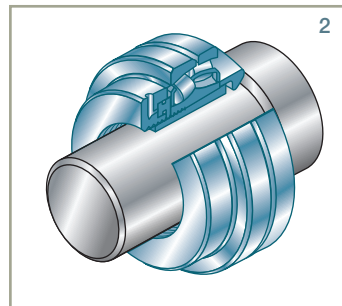

► Heating method

After heating, fit the bearing onto the sleeve. Tighten the nut until the length of the thread exposed at the end of the sleeve is equal to the same length measured at room temperature plus required drive-up values*. Lock the nut in place with the locking washer. Induction heaters such as Fast Therm 20, Fast Therm 35 and Fast Therm 150.

* For control of clearance reduction due to fitting: see page 342.



Adapter and withdrawal sleeves (continued)

■ Removal

► Mechanical method (3)

Loosen the lock nut a few turns. Using a tubular drift, either against the lock nut or against the inner ring on the opposite face from the lock nut, carefully knock the bearing free.

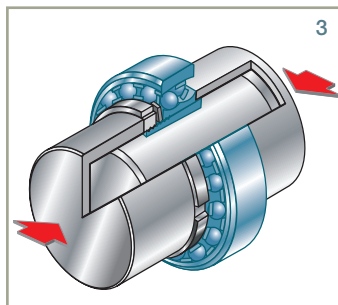

► Hydraulic method (4)

Thread the hydraulic nut onto the sleeves. Take care to ensure the piston is facing away from the bearing. With a tubular « buffer » solidly mounted on the shaft against the piston of the hydraulic nut, inject oil until extraction of the sleeve.

Note: the inner ring must be stopped by an abutment on the shaft.

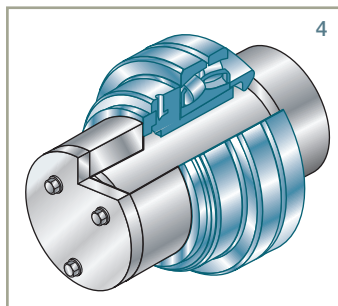

➔ Withdrawal sleeves

The withdrawal sleeve is used in heavy assemblies where the bearings are difficult to handle and adjust. Its removal requires a nut (sold separately) which screws onto the sleeve and presses against one face of the bearing.

The standard taper of bearing bores and sleeves is 1:12 (except for series 240 and 241).

■ Fitting

► Mechanical method (5)

Lubricate the contact surfaces by applying oil to the sleeve and grease to both the sleeve thread and the face of the nut which will be in contact with the sleeve. Drive the sleeve up until the required fit is obtained*. Lock the sleeve in place on the shaft.

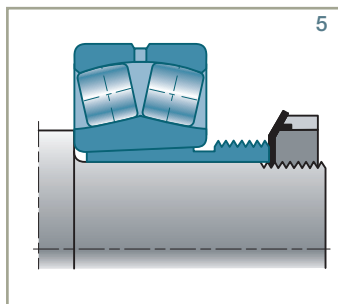

* For control of clearance reduction due to fitting: see page 342.

► Hydraulic method (6)

Lubricate the contact surfaces as per the mechanical method.

Lock the hydraulic nut in place on the shaft.

Inject oil until the required drive-up is obtained*. Lock the sleeve in place on the shaft.

► Heating method

At room temperature place the bearing on the shaft. Drive the sleeve up and tighten the shaft nut until contact is made. Measure the distance « D » between the nut face and the bearing inner ring face.

After heating the bearing, tighten the nut until the distance between nut face/inner ring face is equal to « D » minus the required drive-up*.

Induction heaters such as Fast Therm 20, Fast Therm 35 or Fast Therm 150 are recommended for controlled bearing heating.

■ Removal

The shaft must be equipped with an abutment in order to avoid injury due to a sudden ejection of the sleeve.

► Mechanical method (7)

Tighten the withdrawal nut onto the pre-greased thread of the sleeve until extraction is completed.

► Hydraulic method (8)

Thread the hydraulic nut onto the sleeve so that its piston faces the bearing. Inject oil until extraction is completed.

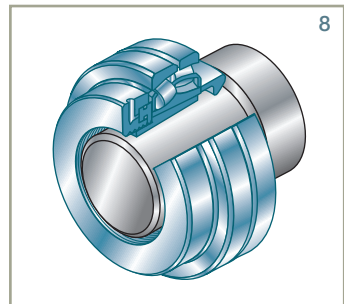
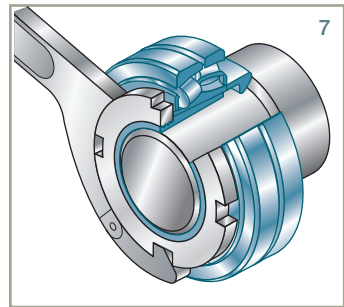
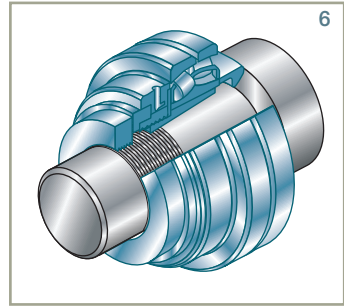

Suffixes

G

Modified thread for conformity to ISO standard 2982-1

* For control of clearance reduction due to fitting: see page 342.



Adapter and withdrawal sleeves (continued)

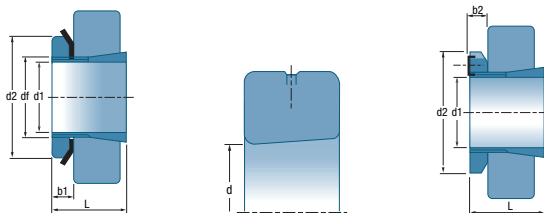

d1	Sleeve	Nut	Washer	d	d2	L	b1	b2	df	
mm	Reference	Ref.	Ref.	mm	mm	mm	mm	mm	mm	kg
17	H204	KM4	MB4	20	32	24	7		M20x1	0.041
	H304	KM4	MB4	20	32	28	7		M20X1	0.045
20	H205	KM5	MB5	25	38	26	8		M25X1.5	0.070
	H305	KM5	MB5	25	38	29	8		M25X1.5	0.075
	H2305	KM5	MB5	25	38	35	8		M25X1.5	0.087
25	H206	KM6	MB6	30	45	27	8		M30X1.5	0.099
	H306	KM6	MB6	30	45	31	8		M30X1.5	0.109
	H2306	KM6	MB6	30	45	38	8		M30X1.5	0.126
30	H207	KM7	MB7	35	52	29	9		M35X1.5	0.125
	H307	KM7	MB7	35	52	35	9		M35X1.5	0.142
	H2307	KM7	MB7	35	52	43	9		M35X1.5	0.165
35	H208	KM8	MB8	40	58	31	10		M40X1.5	0.174
	H308	KM8	MB8	40	58	36	10		M40X1.5	0.189
	H2308	KM8	MB8	40	58	46	10		M40X1.5	0.224
40	H209	KM9	MB9	45	65	33	11		M45X1.5	0.227
	H309	KM9	MB9	45	65	39	11		M45X1.5	0.248
	H2309	KM9	MB9	45	65	50	11		M45X1.5	0.280
45	H210	KM10	MB10	50	70	35	12		M50X1.5	0.274
	H310	KM10	MB10	50	70	42	12		M50X1.5	0.303
	H2310	KM10	MB10	50	70	55	12		M50X1.5	0.362
50	H211	KM11	MB11	55	75	37	12.5		M55X2	0.308
	H311	KM11	MB11	55	75	45	12.5		M55X2	0.345
	H2311	KM11	MB11	55	75	59	12.5		M55X2	0.420
55	H212	KM12	MB12	60	80	38	13		M60X2	0.346
	H312	KM12	MB12	60	80	47	13		M60X2	0.394
	H2312	KM12	MB12	60	80	62	13		M60X2	0.481
60	H213	KM13	MB13	65	85	40	14		M65X2	0.401
	H313	KM13	MB13	65	85	50	14		M65X2	0.458
	H314	KM14	MB14	70	92	52	14		M70X2	0.723
	H2313	KM13	MB13	65	85	65	14		M65X2	0.557
	H2314	KM14	MB14	70	92	68	14		M70X2	0.897
65	H215	KM15	MB15	75	98	43	15		M75X2	0.707
	H315	KM15	MB15	75	98	55	15		M75X2	0.831
	H2315	KM15	MB15	75	98	73	15		M75X2	1.050

Characteristics

■ Adapter sleeve (mm)

d1	Sleeve	Nut	Washer	d	d2	L	b1	b2	df	
mm	Reference	Ref.	Ref.	mm	mm	mm	mm	mm	mm	kg
70	H216	KM16	MB16	80	105	46	17		M80X2	0.882
	H316	KM16	MB16	80	105	59	17		M80X2	1.030
	H2316	KM16	MB16	80	105	78	17		M80X2	1.280
75	H217	KM17	MB17	85	110	50	18		M85X2	1.020
	H317	KM17	MB17	85	110	63	18		M85X2	1.180
	H2317	KM17	MB17	85	110	82	18		M85X2	1.450
80	H218	KM18	MB18	90	120	52	18		M90X2	1.190
	H318	KM18	MB18	90	120	65	18		M90X2	1.370
	H2318	KM18	MB18	90	120	86	18		M90X2	1.690
85	H219	KM19	MB20	95	125	55	19		M95X2	1.370
	H319	KM19	MB19	95	125	68	19		M95X2	1.560
	H2319	KM19	MB19	95	125	90	19		M95X2	1.920
90	H220	KM20	MB20	100	130	58	20		M100X2	1.490
	H320	KM20	MB20	100	130	71	20		M100X2	1.690
	H3120	KM20	MB20	100	130	76	20		M100X2	1.800
	H2320	KM20	MB20	100	130	97	20		M100X2	2.150
100	H222	KM22	MB22	110	145	63	21		M110X2	1.930
	H322	KM22	MB22	110	145	77	21		M110X2	2.180
	H3122	KM22	MB22	110	145	81	21		M110X2	2.250
	H2322	KM22	MB22	110	145	105	21		M110X2	2.740
110	H3024	KML24	MBL24	120	145	72	22		M120X2	1.930
	H3124	KM24	MB24	120	155	88	22		M120X2	2.640
	H2324	KM24	MB24	120	155	112	22		M120X2	3.190
115	H3026	KML26	MBL26	130	155	80	23		M130X2	2.850
	H3126	KM26	MB26	130	165	92	23		M130X2	3.660
	H2326	KM26	MB26	130	165	121	23		M130X2	4.600
125	H3028	KML28	MBL28	140	165	82	24		M140X2	3.160
	H3128	KM28	MB28	140	180	97	24		M140X2	4.340
	H2328	KM28	MB28	150	180	131	24		M140X2	5.550
135	H3030	KML30	MBL30	150	180	87	26		M150X2	3.890
	H3130	KM30	MB30	150	195	111	26		M150X2	5.520
	H2330	KM30	MB30	150	195	139	26		M150X2	6.630
140	H3032	KML32	MBL32	160	190	93	27.5		M160X3	5.210
	H3132	KM32	MB32	160	210	119	28		M160X3	7.670
	H2332	KM32	MB32	160	210	147	28		M160X3	9.140

Adapter and withdrawal sleeves (continued)

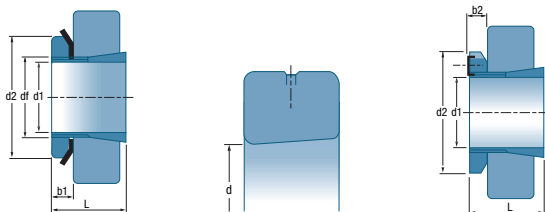

■ Adapter sleeve (mm)
(continued)

d1	Sleeve	Nut	Washer	d	d2	L	b1	b2	df	
mm	Reference	Ref.	Ref.	mm	mm	mm	mm	mm	mm	
150	H3034	KML34	MBL34	170	200	101	28.5		M170X3	5.990
	H3134	KM34	MB34	170	220	122	29		M170X3	8.380
	H2334	KM34	MB34	170	220	154	29		M170X3	10.200
160	H3036	KML36	MBL36	180	210	109	29.5		M180X3	6.830
	H3136	KM36	MB36	180	230	131	30		M180X3	9.500
	H2336	KM36	MB36	180	230	161	30		M180X3	11.300
170	H3038	KML38	MBL38	190	220	112	30.5		M190X3	7.450
	H3138	KM38	MB38	190	240	141	31		M190X3	10.800
	H2338	KM38	MB38	190	240	169	31		M190X3	12.600
180	H3040	KML40	MBL40	200	240	120	31.5		M200X3	9.190
	H3140	KM40	MB40	200	250	150	32		M200X3	12.100
	H2340	KM40	MB40	200	250	176	32		M200X3	13.900
200	H3044H	HM3044	MS3044	220	260	126	30	41	TR220X4	10.300
	H3144	HM44T	MB44	220	280	161	35		TR220X4	15.000
	H2344H	HM44T	MB44	220	280	186	35		TR220X4	17.000
220	H3048H	HM3048	MS3048	240	290	133	34	46	TR240X4	13.200
	H3148H	HM48T	MB48	240	300	172	37		TR240X4	17.600
	H2348H	HM48T	MB48	240	300	199	37		TR240X4	20.000
240	H3052H	HM3052	MS3052	260	310	145	34	46	TR260X4	15.300
	H3152H	HM52T	MB52	260	330	190	39		TR260X4	22.300
	H2352H	HM52T	MB52	260	330	211	39		TR260X4	24.500
260	H3056H	HM3056	MS3056	280	330	152	38	50	TR280X4	17.700
	H3156H	HM56T	MB56	280	350	195	41		TR280X4	25.100
	H2356H	HM56T	MB56	280	350	224	41		TR280X4	28.400
280	H3060H	HM3060	MS3060	300	360	168	42	54	TR300X4	22.800
	H3160H	HM3160	MS3160	300	380	208	40	53	TR300X4	30.200
	H3260H	HM3160	MS3160	300	380	240	40	53	TR300X4	34.100
300	H3064H	HM3064	MS3064	320	380	171	42	55	TR320X5	24.600
	H3164H	HM3164	MS3164	320	400	226	42	56	TR320X5	34.900
320	H3068H	HM3068	MS3068	340	400	187	45	58	TR340X5	28.700
	H3168H	HM3168	MS3168	340	440	254	55	72	TR340X5	50.000
340	H3072H	HM3072	MS3072	360	420	188	45	58	TR360X5	30.500
	H3172H	HM3172	MS3172	360	460	259	58	75	TR360X5	56.000
360	H3076H	HM3076	MS3076	380	450	192	48	62	TR380X5	35.800
380	H3080H	HM3080	MS3080	400	470	210	52	66	TR400X5	41.300

■ Adapter sleeve (inch)

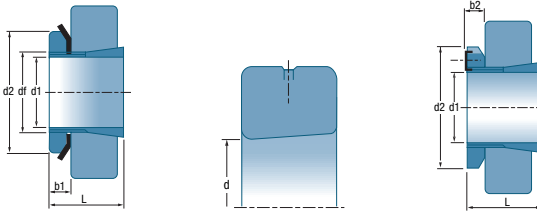

d1'	Sleeve	Nut	Washer	d	d2	L	b1	df	
	Reference	Ref.	Ref.	mm	mm	mm	mm	mm	kg
3/4	H2305-12	KM5	MB5	25	38	35	8	M25X1.5	0.087
7/8	H2306-14	KM6	MB6	30	45	38	8	M30X1.5	0.126
15/16	H2306-15	KM6	MB6	30	45	38	8	M30X1.5	0.126
1	H2306-16	KM6	MB6	30	45	38	8	M30X1.5	0.126
1-1/8	H2307-18	KM7	MB7	35	52	43	9	M35X1.5	0.165
1-3/16	H2307-19	KM7	MB7	35	52	43	9	M35X1.5	0.165
1-1/4	H2307-20	KM7	MB7	35	52	43	9	M35X1.5	0.165
1-1/4	H2308-20	KM8	MB8	40	58	46	10	M40X1.5	0.224
1-5/16	H2308-21	KM8	MB8	40	58	46	10	M40X1.5	0.224
1-3/8	H2308-22	KM8	MB8	40	58	46	10	M40X1.5	0.224
1-7/16	H2309-23	KM9	MB9	45	65	50	11	M45X1.5	0.280
1-1/2	H2309-24	KM9	MB9	45	65	50	11	M45X1.5	0.280
1-9/16	H2309-25	KM9	MB9	45	65	50	11	M45X1.5	0.280
1-5/8	H2310-26	KM10	MB10	50	70	55	12	M50X1.5	0.362
1-11/16	H2310-27	KM10	MB10	50	70	55	12	M50X1.5	0.362
1-3/4	H2310-28	KM10	MB10	50	70	55	12	M50X1.5	0.362
1-7/8	H2311-30	KM11	MB11	55	75	59	12	M55X2	0.420
1-15/16	H2311-31	KM11	MB11	55	75	59	12	M55X2	0.420
2	H2311-32	KM11	MB11	55	75	59	12	M55X2	0.420
2-1/8	H2311-34	KM11	MB11	55	75	59	12	M55X2	0.420
2-3/16	H2313-35	KM13	MB13	65	85	65	14	M65X2	0.557
2-1/4	H2313-36	KM13	MB13	65	85	65	14	M65X2	0.557
2-3/8	H2313-38	KM13	MB13	65	85	65	14	M65X2	0.557
2-7/16	H2313-39	KM13	MB13	65	85	65	14	M65X2	0.557
2-7/16	H2315-39	KM15	MB15	75	98	73	15	M75X2	1.050
2-1/2	H2315-40	KM15	MB15	75	98	73	15	M75X2	1.050
2-11/16	H2316-43	KM16	MB16	80	105	78	17	M80X2	1.280
2-3/4	H2316-44	KM16	MB16	80	105	78	17	M80X2	1.280
2-15/16	H2317-47	KM17	MB17	85	110	82	18	M85X2	1.450
3	H2317-48	KM17	MB17	85	110	82	18	M85X2	1.450
3-1/4	H2319-55	KM19	MB19	95	125	90	19	M95X2	1.920
3-1/2	H2320-56	KM20	MB20	100	130	97	20	M100X2	2.150

Adapter and withdrawal sleeves (continued)

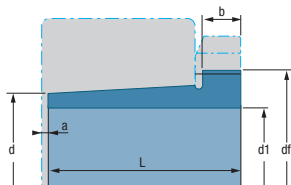

d1	Sleeve	Nut	d	L	a	b	df	
mm	Reference	Ref.	mm	mm	mm	mm	mm	kg
35	AH308	KM9	40.00	29	3	6	M45x1.5	0.090
	AH2308	KM9	40.00	40	3	7	M45x1.5	0.130
40	AH309	KM10	45.00	31	3	6	M50x1.5	0.110
	AH2309	KM10	45.00	44	3	7	M50x1.5	0.160
45	AHX310	KM11	50.00	35	3	7	M55x2	0.140
	AHX2310	KM11	50.00	50	3	9	M55x2	0.210
50	AHX311	KM12	55.00	37	3	7	M60x2	0.160
	AHX2311	KM12	55.00	54	3	10	M60x2	0.260
55	AHX312	KM13	60.00	40	3	8	M65x2	0.190
	AHX2312	KM13	60.00	58	3	11	M65x2	0.300
60	AH313G	KM14	65.00	42	3	8	M70x2	0.230
	AH2313G	KM14	65.00	61	3	12	M70x2	0.360
65	AH314G	KM15	70.00	43	4	8	M75x2	0.250
	AHX2314G	KM15	70.00	64	4	12	M75x2	0.420
70	AH315G	KM16	75.00	45	4.4	8	M80x2	0.290
	AHX2315G	KM16	75.00	68	4	12	M80x2	0.480
75	AH316	KM18	80.00	48	4	8	M90x2	0.370
	AHX2316	KM18	80.00	72	4	12	M90x2	0.600
80	AHX317	KM19	85.00	52	4	9	M95x2	0.430
	AHX2317	KM19	85.00	74	4	13	M95x2	0.670
85	AHX318	KM20	90.00	53	4	9	M100x2	0.460
	AHX2318	KM20	90.00	79	4	14	M100x2	0.780
	AHX3218	KM20	90.00	79	4	10	M100x2	0.580
90	AHX319	KM21	95.00	57	4	10	M105x2	0.530
	AHX2319	KM21	95.00	85	4	16	M105x2	0.900
95	AHX320	KM22	100.00	59	4	10	M110x2	0.600
	AHX3120	KM22	100.00	64	4	11	M110x2	0.650
	AHX3220	KM22	100.00	73	4	11	M110x2	0.770
	AHX2320	KM22	100.00	90	4	16	M110x2	1.000

■ Withdrawal sleeve

d1	Sleeve	Nut	d	L	a	b	df	
mm	Reference	Ref.	mm	mm	mm	mm	mm	kg
105	AHX322	KM24	110.00	63	4	12	M120x2	0.710
	AHX3122	KM24	110.00	68	4	11	M120x2	0.760
	AHX3222G	KM24	110.00	82	4	11	M120x2	1.000
	AH24122	KM23	110.00	82	9	13	M115x2	0.710
	AHX2322G	KM24	110.00	98	4	16	M120x2	1.260
115	AHX3024	KM26	120.00	60	4	13	M130x2	0.750
	AH24024	KM25	120.00	73	9	13	M125x2	0.650
	AHX3124	KM26	120.00	75	4	12	M130x2	0.950
	AHX3224G	KM26	120.00	90	4	13	M130x2	1.200
	AH24124	KM26	120.00	93	9	13	M130x2	1.000
	AHX2324G	KM26	120.00	105	4	17	M130x2	1.490
125	AHX3026	KM28	130.00	67	4	14	M140x2	0.930
	AHX3126	KM28	130.00	78	4	12	M140x2	1.090
	AH24026	KM27	130.00	83	9	14	M135x2	0.840
	AH24126	KM28	130.00	94	9	14	M140x2	1.150
	AHX3226G	KM28	130.00	98	4	15	M140x2	1.470
	AHX2326G	KM28	130.00	115	4	19	M140x2	1.830
135	AHX3028	KM30	140.00	68	5	14	M150x2	1.010
	AHX3128	KM30	140.00	83	5	14	M150x2	1.280
	AH24028	KM29	140.00	83	10	14	M150x2	0.940
	AH24128	KM30	140.00	99	10	14	M150x2	1.250
	AHX3228G	KM30	140.00	104	5	15	M150x2	1.720
	AHX2328G	KM30	140.00	125	5	20	M150x2	2.220
145	AHX3030	KM32	150.00	72	5	15	M160x3	1.150
	AH24030	KM31	150.00	90	11	15	M155x3	1.110
	AHX3130G	KM32	150.00	96	5	15	M160x3	1.640
	AH24130	KM32	150.00	115	11	15	M160x3	1.600
	AHX2330G	KM32	150.00	135	5	24	M160x3	2.600
	AHX3230G	KM32	150.00	135	5	17	M160x3	2.070
150	AH3032	KM34	160.00	77	5	16	M170x3	2.060
	AH24032	KM34	160.00	95	11	15	M170x3	2.270
	AH3132G	KM34	160.00	103	5	16	M170x3	2.900
	AH3232G	KM34	160.00	124	6	20	M170x3	3.630
	AH24132	KM34	160.00	124	11	15	M170x3	3.000
	AH2332G	KM34	160.00	140	6	24	M170x3	4.240



Adapter and withdrawal sleeves (continued)

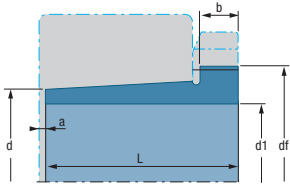

d1	Sleeve	Nut	d	L	a	b	df	
mm	Reference	Ref.	mm	mm	mm	mm	mm	kg
160	AH3034	KM36	170.00	85	5	17	M180x3	2.430
	AH3134G	KM36	170.00	104	5	16	M180x3	3.210
160	AH24034	KM36	170.00	106	11	16	M180X3	2.700
	AH24134	KM36	170.00	125	11	16	M180x3	3.210
	AH3234G	KM36	170.00	134	6	24	M180x3	4.350
	AH2334G	KM36	170.00	146	6	24	M180x3	4.810
170	AH3036	KM38	180.00	92	6	17	M190X3	2.810
	AH2236G	KM38	180.00	105	6	17	M190X3	3.390
	AH3136G	KM38	180.00	116	6	19	M190X3	3.770
	AH24036	KM38	180.00	116	11	16	M190X3	3.100
	AH24136	KM38	180.00	134	11	16	M190x3	3.720
	AH3236G	KM38	180.00	140	6	26	M190X3	5.400
	AH2336G	KM38	180.00	154	6	26	M190X3	5.400
180	AH3038G	KM40	190.00	96	6	18	M200X3	3.160
	AH2238G	KM40	190.00	112	6	18	M200X3	4.200
	AH24038	KM40	190.00	118	13	18	M200X3	3.460
	AH3138G	KM40	190.00	125	6	20	M200X3	4.380
	AH3238G	KM40	190.00	145	7	25	M200X3	5.300
	AH24138	KM40	190.00	146	13	18	M200X3	4.280
	AH2338G	KM40	190.00	160	7	26	M200X3	6.040
190	AH3040G	HM44T	200.00	102	6	19	TR210x4	3.570
	AH2240	HM44T	200.00	118	6	19	TR220x4	4.680
	AH24040	HM44T	200.00	127	13	18	TR210x4	3.930
	AH3140	HM44T	200.00	134	6	21	TR220x4	5.550
	AH3240	HM44T	200.00	153	7	25	TR220x4	6.590
	AH24140	HM44T	200.00	158	13	18	TR210x4	5.100
	AH2340	HM44T	200.00	170	7	30	TR220x4	7.540
	200	AOH3044G	HM46T	220.00	111	6	20	TR230x4
AOH2244		HM48T	220.00	130	6	20	TR240x4	9.100
AOH24044		HM46T	220.00	138	14	20	TR230x4	8.250
AOH3144		HM48T	220.00	145	6	23	TR240x4	10.400
AOH24144		HM46T	220.00	170	14	20	TR230x4	10.200
AOH2344		HM48T	220.00	181	8	30	TR240x4	13.500
220	AOH3048	HM52T	240.00	116	7	21	TR260x4	8.750
	AOH24048	HM50T	240.00	138	15	20	TR250x4	9.000

■ Withdrawal sleeve (continued)

d1	Sleeve	Nut	d	L	a	b	df	
mm	Reference	Ref.	mm	mm	mm	mm	mm	kg
220	AOH3148	HM52T	240.00	154	7	25	TR260x4	12.000
	AOH24148	HM52T	240.00	180	15	20	TR260x4	12.500
	AOH2348	HM52T	240.00	189	8	30	TR260x4	15.500
240	AOH3052	HM56T	260.00	128	7	23	TR280x4	10.700
	AOH24052G	HM56T	260.00	162	16	22	TR280X4	12.300
	AOH3152G	HM56T	260.00	172	7	26	TR280x4	16.200
	AOH24152	HM56T	260.00	202	16	22	TR280x4	15.400
	AOH2352G	HM56T	260.00	205	8	30	TR280x4	18.900
260	AOH3056	HM3060	280.00	131	8	24	TR300x4	12.000
	AOH24056G	HM3160	280.00	162	17	22	TR300X4	13.400
	AOH3156G	HM3160	280.00	175	8	28	TR300x4	17.100
	AOH24156	HM3160	280.00	202	17	22	TR300x4	16.300
	AOH2356G	HM3160	280.00	212	8	30	TR300x4	21.300
280	AOH3060	HM3064	300.00	145	8	26	TR320x5	14.400
	AOH24060G	HM3164	300.00	184	18	24	TR320x5	16.400
	AOH3160G	HM3164	300.00	192	8	30	TR320x5	20.400
	AOH24160	HM3164	300.00	224	18	24	TR320x5	20.200
	AOH3260G	HM3164	300.00	228	8	34	TR320x5	23.400
300	AOH3064G	HM3068	320.00	149	8	27	TR340x5	15.600
	AOH3164G	HM3168	320.00	209	8	31	TR340x5	23.600
	AOH24164	HM3168	320.00	242	18	24	TR340x5	21.400
320	AOH3068G	HM3072	340.00	162	9	28	TR360x5	18.600
	AOH3168G	HM3172	340.00	225	9	33	TR360x5	27.600
340	AOH3072G	HM3076	360.00	167	9	30	TR380x5	20.400
	AOH3172G	HM3176	360.00	229	9	35	TR380x5	30.600
	AH24172H	HM3176	360.00	269	20	26	TR380x5	30.000
360	AOH3076G	HM3080	380.00	170	10	31	TR400x5	22.700
380	AOH3080G	HM3084	400.00	183	10	33	TR420x5	26.100



Nuts and washers

Clamping and withdrawal nut

The clamping and withdrawal nuts (Standard ISO 2982) are used for axial locking of bearings with:

- cylindrical bore
- tapered bore

and for the extraction of a withdrawal sleeve.

When used for axial attachment, they are mounted with the corresponding tabwasher or locking stirrup with a suitable hexagonal head bolt, thereby making a simple low-cost and low-footprint clamping device.

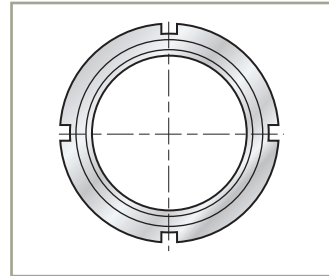

Lock-washer (small dimensions)

The lock-washer (Standard ISO 2982) provides for positive locking of the clamping nut on the shaft. A groove has to be machined in the shaft if the lock-washer is used. The large number of tabs in the lock-washer enables the nut to be locked in the exactly right adjustment position.

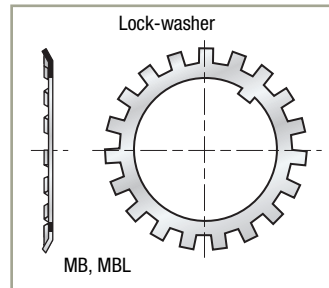

Locking stirrup

This is a suitable system for large size nut safetying.

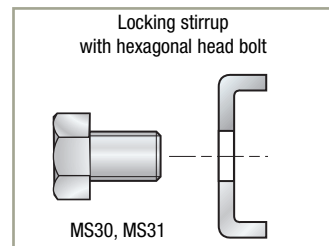

Characteristics

■ Locking nut

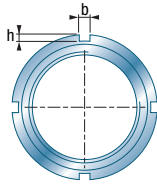
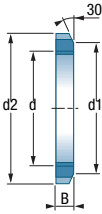

d		G	d2	d1	B	b	h		corresponding lock-washer
mm	Reference	mm	mm	mm	mm	mm	mm	kg	Reference
10	KM0	M10 X 0.75	18	13.5	4	3	2.0	0.005	MB 0
12	KM1	M12 X 1	22	17	4	3	2.0	0.007	MB 1
15	KM2	M15 X 1	25	21	5	4	2.0	0.010	MB 2
17	KM3	M17 X 1	28	24	5	4	2.0	0.013	MB 3
20	KM4	M20 X 1	32	26	6	4	2.0	0.019	MB 4
25	KM5	M25 X 1.5	38	32	7	5	2.0	0.025	MB 5
30	KM6	M30 X 1.5	45	38	7	5	2.0	0.043	MB 6
35	KM7	M35 X 1.5	52	44	8	5	2.0	0.053	MB 7
40	KM8	M40 X 1.5	58	50	9	6	2.5	0.085	MB 8
45	KM9	M45 X 1.5	65	56	10	6	2.5	0.120	MB 9
50	KM10	M50 X 1.5	70	61	11	6	2.5	0.150	MB 10
55	KM11	M55 X 2	75	67	11	7	3.0	0.160	MB 11
60	KM12	M60 X 2	80	73	11	7	3.0	0.170	MB 12
65	KM13	M65 X 2	85	79	12	7	3.0	0.200	MB 13
70	KM14	M70 X 2	92	85	12	8	3.5	0.240	MB 14
75	KM15	M75 X 2	98	90	13	8	3.5	0.290	MB 15
80	KM16	M80 X 2	105	95	15	8	3.5	0.400	MB 16
85	KM17	M85 X 2	110	102	16	8	3.5	0.450	MB 17
90	KM18	M90 X 2	120	108	16	10	4.0	0.560	MB 18
95	KM19	M95 X 2	125	113	17	10	4.0	0.660	MB 19
100	KM20	M100 X 2	130	120	18	10	4.0	0.700	MB 20
105	KM21	M105 X 2	140	126	18	12	5.0	0.850	MB 21
110	KM22	M110 X 2	145	133	19	12	5.0	0.970	MB 22
115	KM23	M115 X 2	150	137	19	12	5.0	1.010	MB 23
120	KM24	M120 X 2	155	138	20	12	5.0	1.080	MB 24
125	KM25	M125 X 2	160	148	21	12	5.0	1.190	MB 25
130	KM26	M130 X 2	165	149	21	12	5.0	1.250	MB 26
135	KM27	M135 X 2	175	160	22	14	6.0	1.550	MB 27
140	KM28	M140 X 2	180	160	22	14	6.0	1.560	MB 28
145	KM29	M145 X 2	190	172	24	14	6.0	2.000	MB 29
150	KM30	M150 X 2	195	171	24	14	6.0	2.030	MB 30



Nuts and washers (continued)

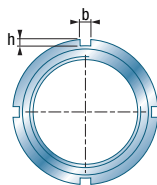
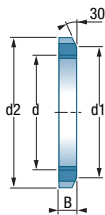

■ Locking nut (continued)

d	G	d2	d1	B	b	H		corresponding lock-washer	
mm	mm	mm	mm	mm	mm	mm	kg	Reference	
155	KM31	M155 X 3	200	182	25	16	7.0	2.210	MB 31
160	KM32	M160 X 3	210	182	25	16	7.0	2.590	MB 32
165	KM33	M165 X 3	210	193	26	16	7.0	2.700	MB 33
170	KM34	M170 X 3	220	193	26	16	7.0	2.800	MB 34
180	KM36	M180 X 3	230	203	27	18	8.0	3.070	MB 36
190	KM38	M190 X 3	240	214	28	18	8.0	3.390	MB 38
200	KML40	M200 X 3	240	222	29	18	8.0	2.980	MBL 40
200	KM40	M200 X 3	250	226	29	18	8.0	3.690	MB 40
205	HML41T	TR205 X 4	250	232	30	18	8.0	3.430	MB 42
210	HM42T	TR210 X 4	270	238	30	20	10.0	4.750	
215	HML43T	TR215 X 4	260	242	30	20	9.0	3.720	
220	HM3044	TR220 X 4	260	242	30	20	9.0	3.090	MS 3044
220	HM44T	TR220 X 4	280	250	32	20	10.0	5.350	MB 44
230	HM46T	TR230 X 4	290	260	34	20	10.0	5.800	MB 46
240	HM3048	TR240 X 4	290	270	34	20	10.0	5.160	MS 3048
240	HM48T	TR240 X 4	300	270	34	20	10.0	6.200	MB 48
260	HM3052	TR260 X 4	310	290	34	20	10.0	5.670	MS 3052
260	HM52T	TR260 X 4	330	300	35	24	12.0	8.400	MB 52
280	HM3056	TR280 X 4	330	310	38	24	10.0	6.780	MS 3056
280	HM56T	TR280 X 4	350	320	36	24	12.0	9.600	MB 56
300	HM3060	TR300 X 4	360	336	42	24	12.0	9.620	MS 3060
300	HM3160	TR300 X 4	380	340	40	24	12.0	11.700	MS 3160
320	HM3064	TR320 X 5	380	356	42	24	12.0	9.940	MS 3064
320	HM3164	TR320 X 5	400	360	42	24	12.0	13.000	MS 3164
340	HM3068	TR340 X 5	400	376	45	24	12.0	11.700	MS 3068
340	HM3168	TR340 X 5	440	400	55	28	15.0	23.000	MS 3168
360	HM3072	TR360 X 5	420	394	45	28	13.0	12.000	MS 3072
360	HM3172	TR360 X 5	460	420	58	28	15.0	25.000	MS 3172
380	HM3076	TR380 X 5	450	422	48	28	14.0	14.900	MS 3076
380	HM3176	TR380 X 5	490	440	60	32	18.0	30.800	MS 3176
400	HM3080	TR400 X 5	470	442	52	24	14.0	16.900	MS 3080
420	HM3084	TR420 X 5	490	462	52	32	14.0	17.400	MS 3084

Lock-washer

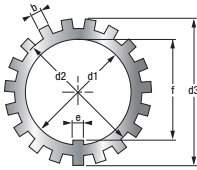

d1		d3	d2	e	f	b	s		corresponding slotted nut
mm	Reference	mm	mm	mm	mm	mm	mm	kg	Reference
10	MB 0	21	13.5	3	8.50	3	1.00	0.130	KM0
12	MB 1	25	17	3	10.50	3	1.00	0.190	KM1
15	MB 2	28	21	4	13.50	4	1.00	0.250	KM2
17	MB 3	32	24	4	15.50	4	1.00	0.310	KM3
20	MB 4	36	26	4	18.50	4	1.00	0.350	KM4
25	MB 5	42	32	5	23.00	5	1.25	0.640	KM5
30	MB 6	49	38	5	27.50	5	1.25	0.780	KM6
35	MB 7	57	44	6	32.50	5	1.25	1.040	KM7
40	MB 8	62	50	6	37.50	6	1.25	1.230	KM8
45	MB 9	69	56	6	42.50	6	1.25	1.520	KM9
50	MB 10	74	61	6	47.50	6	1.25	1.600	KM10
55	MB 11	81	67	8	52.50	7	1.25	1.960	KM11
60	MB 12	86	73	8	57.50	7	1.50	2.530	KM12
65	MB 13	92	79	8	62.50	7	1.50	2.900	KM13
70	MB 14	98	85	8	66.50	8	1.50	3.340	KM14
75	MB 15	104	90	8	71.50	8	1.50	3.560	KM15
80	MB 16	112	95	10	76.50	8	1.75	4.640	KM16
85	MB 17	119	102	10	81.50	8	1.75	5.240	KM17
90	MB 18	126	108	10	86.50	10	1.75	6.230	KM18
95	MB 19	133	113	10	91.50	10	1.75	6.700	KM19
100	MB 20	142	120	12	96.50	10	1.75	7.650	KM20
105	MB 21	145	126	12	100.50	12	1.75	8.260	KM21
110	MB 22	154	133	12	105.50	12	1.75	9.400	KM22
115	MB 23	159	137	12	110.50	12	2.00	10.800	KM23
120	MB 24	164	138	14	115.00	12	2.00	10.500	KM24
125	MB 25	170	148	14	120.00	12	2.00	11.800	KM25
130	MB 26	175	149	14	125.00	12	2.00	11.300	KM26
135	MB 27	185	160	14	130.00	14	2.00	14.400	KM27
140	MB 28	192	160	16	135.00	14	2.00	14.200	KM28
145	MB 29	202	172	16	140.00	14	2.00	16.800	KM29



Nuts and washers (continued)

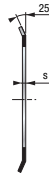
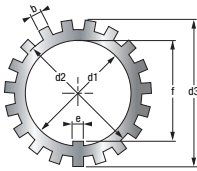

■ Lock-washer (continued)

d1		d3	d2	e	f	b	s		corresponding slotted nut
mm	Reference	mm	mm	mm	mm	mm	mm	kg	Reference
150	MB 30	205	171	16	145.00	14	2.00	15.50	KM30
155	MB 31	212	182	16	147.50	16	2.50	20.90	KM31
160	MB 32	217	182	18	154.00	16	2.50	22.20	KM32
165	MB 33	222	193	18	157.50	16	2.50	24.10	KM33
170	MB 34	232	193	18	164.00	16	2.50	24.70	KM34
180	MB 36	242	203	20	174.00	18	2.50	26.80	KM36
190	MB 38	252	214	20	184.00	18	2.50	27.80	KM38
200	MBL 40	245	222	20	194.00	18	2.50	21.40	KLM40
200	MB 40	262	226	20	194.00	18	2.50	29.30	KM40
220	MB 44	292	250	24	213.00	20	3.00	35.00	HM44T
240	MB 48	312	270	24	233.00	20	3.00	45.00	HM48T
260	MB 52	342	300	28	253.00	24	3.00	65.00	HM52T
280	MB 56	362	320	28	273.00	24	3.00	105.00	HM56T

■ Stirrup

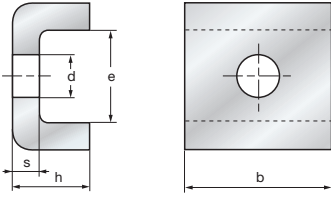

	s	b	h	d	e	screw	corresponding nut
Reference	mm	mm	mm	mm	mm	Ref.	Ref.
MS 3044	4	20	12	7	13.5	M6X16	HM3044
MS 3048	4	20	12	9	17.5	M8X20	HM3048
MS 3052	4	20	12	9	17.5	M8X20	HM3052
MS 3056	4	24	12	9	17.5	M8X20	HM3056
MS 3060	4	24	12	9	20.5	M8X20	HM3060
MS 3064	5	24	15	9	21.0	M8X20	HM3064
MS 3068	5	24	15	9	21.0	M8X20	HM3068
MS 3072	5	28	15	9	20.0	M8X20	HM3072
MS 3076	5	28	15	12	24.0	M10X25	HM3076
MS 3080	5	28	15	12	24.0	M10X25	HM3080
MS 3160	4	24	12	12	30.5	M10X25	HM3160
MS 3164	5	24	15	12	31.0	M10X25	HM3164
MS 3168	5	28	15	14	38.0	M12X30	HM3168
MS 3172	5	28	15	14	38.0	M12X30	HM3172



Self-locking precision nuts

Description

The self-locking precision nuts are assembly accessories that must be used in cases such as the following:

- When a preloading of the bearings package is required to guarantee the maintenance of the preloading time-value.
- When a high precision bearing assembly is being used, since this requires the use of accessories which will maintain the precision level of the equipment as a whole.
- When the setting of the position of the bearings package must be reliable and long-lasting, even when it is not preloaded (especially if the presence of significant axial efforts is foreseen during the operation of the equipment).

Overall, this type of nuts are used with ball bearings of angular contact (wether high precision or not), with cone bearings or with combined needle bearings.

Due to the high operating precision of these accessories due to an operation carried out on the equipment, at least whenever the nut has to be dismantled.

The self-locking precision nuts assure their position by means of two or four locking elements. These elements are grafts of softer material than steel, that are mechanized during the same operation as that of the interior thread of the nut and are then fitted into the thread of the axle. Nevertheless, this does not modify the perpendicularity of the lateral face of the nut in relation to the axle of the nut. The grafts are fixed to head screws with an inside hexagon, centered on these elements.

Series

■ Series with blind holes

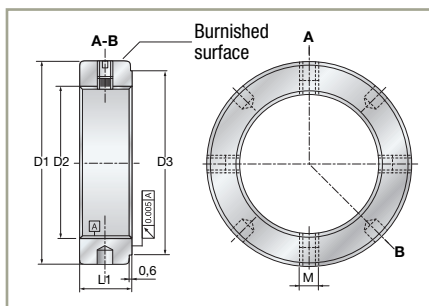

■ Castellated series

The SNR range of precision self-locking nuts offers a complementary series whose difference lies in the tightening system. Tightening/locking is obtained by castellated design, instead of blind holes. The part numbers for these products are shown in the tables below.

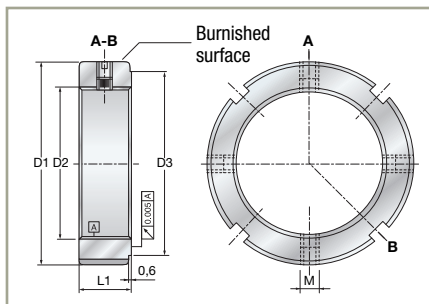

Variants

Castellated series	Series with blind holes	Section	Number of inserts	Thread diameter	Material	Strength	Application
B	TB	Narrow	2	20 to 100 mm	High strength burnished steel	1 000 N/mm ²	Normal use
BR	TBR		4				Mean loads, maximum flatness requirement
BP	TBP	Wide	2				High loads
BPR	TBPR		4				Very high loads, maximum flatness requirement

Tolerances

The thread and the flat side of the nut which leans against the bearing are machined in the same fixation, which enables it to reach a high perpendicularity precision of: 0,005 millimeter tolerance.

The thread is in accordance with the rules ISO R/724 with a 5H tolerance and in accordance with ISO 965/1.

Design criteria

The unlocking momentum **M_d**, which is shown on the dimension tables for each type and size of nut is the power needed to apply to loosen this self-locking nut when it has been assembled previously by means of a tightening momentum **M_a**, and fixed via the tightening of the locking elements against the axle with a maximum tightening power of these elements **M_{bl}**, as shown in the tables.

The breaking axial load **F_{ar}**, also shown in the dimension tables, is the axial load which if applied to the nut will produce the breakage of the thread when it is assembled on an axle with a nut tolerance of 60. While operating, the maximum axial load which a nut can bear must be 75% of the breaking axial load **F_{ar}**, defined for such a nut.

Installation/assembly criteria

Since we are dealing with a high precision element, the nuts must be unwrapped until they are going to be used in order to avoid possible mechanical damage or dirt in the thread or on the push side.

They must lean on the covered side of the polished surface.

Once the thread is tightened with a spanner wrench (DIN 1810A and DIN 1810B), the fixation screws of the locking elements are tightened by use of an Allen wrench (for series containing four grafts, tightening these progressively crosswise).

SNR features a wide range of wrenches especially designed for your requirements.



Self-locking precision nuts (continued)

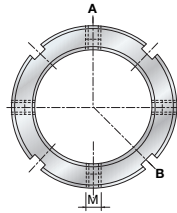
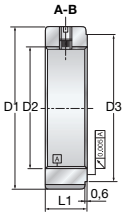

■ Castellated, narrow series

D2		L1	D1	D3	M	Mbl	Far	Ma	Md	
Thread	Reference	mm	mm	mm	mm	N.m	kN	N.m	N.m	kg
M8x0.75	B 8/0.75	8	16	11	M4	1	27	4	26	0.01
M12x1	B 12/1	8	22	18	M4	1	47	8	31	0.015
M15x1	B 15/1	8	25	21	M4	1	65	10	32	0.02
M17x1	B 17/1	10	28	24	M5	3	100	15	32	0.03
M20x1	B 20/1	10	32	28	M5	5	140	18	39	0.04
M20x1.5	B 20/1.5	10	32	28	M5	5	126	18	39	0.04
M 25x1.5	B 25	12	38	33	M5	5	198	25	56	0.06
M 30x1.5	B 30	12	45	40	M5	5	240	32	63	0.08
M 35x1.5	B 35	12	52	47	M5	5	263	40	72	0.11
M 40x1.5	B 40	14	58	52	M6	10	290	55	97	0.15
M 45x1.5	B 45	14	65	59	M6	10	322	65	115	0.18
M 50x1.5	B 50	14	70	64	M6	10	351	85	132	0.20
M 55x2	B 55	16	75	68	M8	18	378	95	148	0.25
M 60x2	B 60	16	80	73	M8	18	405	100	186	0.27
M 65x2	B 65	16	85	78	M8	18	431	120	196	0.28
M 70x2	B 70	18	92	85	M8	18	468	130	228	0.38
M 75x2	B 75	18	98	90	M8	18	497	150	255	0.42
M 80x2	B 80	18	105	95	M8	18	527	160	291	0.49
M 85x2	B 85	18	110	100	M8	18	558	190	315	0.52
M 90x2	B 90	20	120	110	M8	18	603	200	369	0.75
M 95x2	B 95	20	125	115	M8	18	637	220	391	0.78
M 100x2	B 100	20	130	120	M8	18	688	250	432	0.82
<hr/>										
M 25x1.5	BR 25	12	38	33	M5	4	198	25	85	0.06
M 30x1.5	BR 30	12	45	40	M5	4	240	32	96	0.08
M 35x1.5	BR 35	12	52	47	M5	4	263	40	107	0.11
M 40x1.5	BR 40	14	58	52	M6	8	290	55	127	0.15
M 45x1.5	BR 45	14	65	59	M6	8	322	65	149	0.18
M 50x1.5	BR 50	14	70	64	M6	8	351	85	180	0.20
M 55x2	BR 55	16	75	68	M8	14	378	95	206	0.25
M 60x2	BR 60	16	80	73	M8	14	405	100	255	0.27
M 65x2	BR 65	16	85	78	M8	14	431	120	277	0.28
M 70x2	BR 70	18	92	85	M8	14	468	130	304	0.38
M 75x2	BR 75	18	98	90	M8	14	497	150	357	0.42
M 80x2	BR 80	18	105	95	M8	14	527	160	396	0.49
M 85x2	BR 85	18	110	100	M8	14	558	190	444	0.52
M 90x2	BR 90	20	120	110	M8	14	603	200	501	0.75
M 95x2	BR 95	20	125	115	M8	14	637	220	550	0.78
M 100x2	BR 100	20	130	120	M8	14	688	250	603	0.82

Far: Ultimate axial load / **Ma:** Tightening torque / **Md:** Brake-away torque corresponding to indicated Ma

Mbl: Max. tightening torque recommended for attachment bolts / **D1:** Outer diameter / **D3:** Bearing face diameter / **L1:** Width

Blind holes, narrow serie

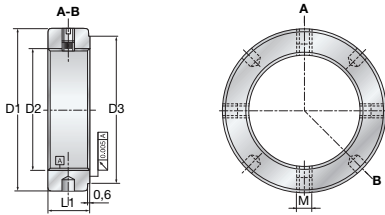

D2		L1	D1	D3	M	Mbl	Far	Ma	Md	
Thread	Reference	mm	mm	mm	mm	N.m	kN	N.m	N.m	kg
M20x1	TB 20/1	10	32	28	M5	5	140	18	39	0.04
M20x1.5	TB 20/1.5	10	32	28	M5	5	126	18	39	0.04
M 25x1.5	TB 25	12	38	33	M5	5	198	25	56	0.06
M 30x1.5	TB 30	12	45	40	M5	5	240	32	63	0.08
M 35x1.5	TB 35	12	52	47	M5	5	263	40	72	0.11
M 40x1.5	TB 40	14	58	52	M6	10	290	55	97	0.15
M 45x1.5	TB 45	14	65	59	M6	10	322	65	115	0.18
M 50x1.5	TB 50	14	70	64	M6	10	351	85	132	0.20
M 55x2	TB 55	16	75	68	M8	18	378	95	148	0.25
M 60x2	TB 60	16	80	73	M8	18	405	100	186	0.27
M 65x2	TB 65	16	85	78	M8	18	431	120	196	0.28
M 70x2	TB 70	18	92	85	M8	18	468	130	228	0.38
M 75x2	TB 75	18	98	90	M8	18	497	150	255	0.42
M 80x2	TB 80	18	105	95	M8	18	527	160	291	0.49
M 85x2	TB 85	18	110	100	M8	18	558	190	315	0.52
M 90x2	TB 90	20	120	110	M8	18	603	200	369	0.75
M 95x2	TB 95	20	125	115	M8	18	637	220	391	0.78
M 100x2	TB 100	20	130	120	M8	18	688	250	432	0.82
<hr/>										
M 25x1.5	TBR 25	12	38	33	M5	4	198	25	85	0.06
M 30x1.5	TBR 30	12	45	40	M5	4	240	32	96	0.08
M 35x1.5	TBR 35	12	52	47	M5	4	263	40	107	0.11
M 40x1.5	TBR 40	14	58	52	M6	8	290	55	127	0.15
M 45x1.5	TBR 45	14	65	59	M6	8	322	65	149	0.18
M 50x1.5	TBR 50	14	70	64	M6	8	351	85	180	0.20
M 55x2	TBR 55	16	75	68	M8	14	378	95	206	0.25
M 60x2	TBR 60	16	80	73	M8	14	405	100	255	0.27
M 65x2	TBR 65	16	85	78	M8	14	431	120	277	0.28
M 70x2	TBR 70	18	92	85	M8	14	468	130	304	0.38
M 75x2	TBR 75	18	98	90	M8	14	497	150	357	0.42
M 80x2	TBR 80	18	105	95	M8	14	527	160	396	0.49
M 85x2	TBR 85	18	110	100	M8	14	558	190	444	0.52
M 90x2	TBR 90	20	120	110	M8	14	603	200	501	0.75
M 95x2	TBR 95	20	125	115	M8	14	637	220	550	0.78
M 100x2	TBR 100	20	130	120	M8	14	688	250	603	0.82

Far: Ultimate axial load / **Ma:** Tightening torque / **Md:** Brake-away torque corresponding to indicated Ma

Mbl: Max. tightening torque recommended for attachment bolts / **D1:** Outer diameter / **D3:** Bearing face diameter / **L1:** Width

Self-locking precision nuts (continued)

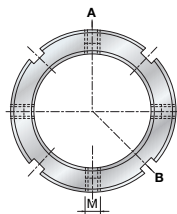
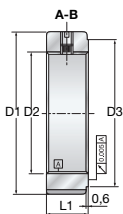

■ Castellated, wide series

D2		L1	D1	D3	M	Mbl	Far	Ma	Md	
Thread	Reference	mm	mm	mm	mm	N.m	kN	N.m	N.m	kg
M20x1	BP20/1	20	38	28	M5	5	255	18	39	0.12
M20x1.5	BP 20/1.5	20	38	28	M5	5	225	18	39	0.12
M25x1.5	BP 25	20	45	33	M6	10	405	25	56	0.17
M 30x1.5	BP 30	22	52	40	M6	10	491	32	63	0.24
M 35x1.5	BP 35	22	58	47	M6	10	560	40	72	0.28
M 40x1.5	BP 40	22	62	52	M8	18	585	55	97	0.29
M 45x1.5	BP 45	24	68	59	M8	18	641	65	115	0.37
M 50x1.5	BP 50	25	75	64	M8	18	706	85	132	0.46
M 55x2	BP 55	32	88	68	M8	18	940	95	148	0.92
M 60x2	BP 60	32	98	73	M8	18	1 070	100	186	1.14
M 65x2	BP 65	32	105	78	M8	18	1 155	120	196	1.29
M 70x2	BP 70	35	110	85	M8	18	1 230	130	228	1.49
M 75x2	BP 75	38	125	90	M10	32	1 300	150	255	2.25
M 80x2	BP 80	38	140	95	M10	32	1 420	160	291	2.97
M 85x2	BP 85	38	150	100	M10	32	1 510	190	315	3.44
M 90x2	BP 90	38	155	110	M10	32	1 596	200	369	3.59
M 95x2	BP 95	38	160	115	M10	32	1 656	220	391	3.73
M 100x2	BP 100	40	160	120	M10	32	1 780	250	432	3.70
M20x1	BPR 20/1	20	38	28	M5	4	255	18	56	0.12
M20x1.5	BPR 20/1.5	20	38	28	M5	4	225	18	56	0.12
M 25x1.5	BPR 25	20	45	33	M6	8	405	25	85	0.17
M 30x1.5	BPR 30	22	52	40	M6	8	491	32	96	0.24
M 35x1.5	BPR 35	22	58	47	M6	8	560	40	107	0.28
M 40x1.5	BPR 40	22	62	52	M8	14	585	55	127	0.29
M 45x1.5	BPR 45	24	68	59	M8	14	641	65	149	0.37
M 50x1.5	BPR 50	25	75	64	M8	14	706	85	180	0.46
M 55x2	BPR 55	32	88	68	M8	14	940	95	206	0.92
M 60x2	BPR 60	32	98	73	M8	14	1 070	100	255	1.14
M 65x2	BPR 65	32	105	78	M8	14	1 155	120	277	1.29
M 70x2	BPR 70	35	110	85	M8	14	1 230	130	304	1.49
M 75x2	BPR 75	38	125	90	M10	26	1 300	150	357	2.25
M 80x2	BPR 80	38	140	95	M10	26	1 420	160	396	2.97
M 85x2	BPR 85	38	150	100	M10	26	1 510	190	444	3.44
M 90x2	BPR 90	38	155	110	M10	26	1 596	200	501	3.59
M 95x2	BPR 95	38	160	115	M10	26	1 656	220	550	3.73
M 100x2	BPR 100	40	160	120	M10	26	1 780	250	603	3.70

Far: Ultimate axial load / **Ma:** Tightening torque / **Md:** Brake-away torque corresponding to indicated Ma

Mbl: Max. tightening torque recommended for attachment bolts / **D1:** Outer diameter / **D3:** Bearing face diameter / **L1:** Width

■ Blind holes, wide series

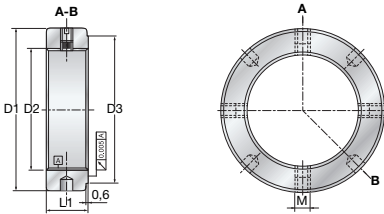

D2		L1	D1	D3	M	Mbl	Far	Ma	Md	
Thread	Reference	mm	mm	mm	mm	N.m	kN	N.m	N.m	kg
M20x1	TBP 20/1	20	38	28	M5	5	255	18	39	0.12
M20x1.5	TBP 20/1.5	20	38	28	M5	5	225	18	39	0.12
M 25x1.5	TBP 25	20	45	33	M6	10	405	25	56	0.17
M 30x1.5	TBP 30	22	52	40	M6	10	491	32	63	0.24
M 35x1.5	TBP 35	22	58	47	M6	10	560	40	72	0.28
M 40x1.5	TBP 40	22	62	52	M8	18	585	55	97	0.29
M 45x1.5	TBP 45	24	68	59	M8	18	641	65	115	0.37
M 50x1.5	TBP 50	25	75	64	M8	18	706	85	132	0.46
M 55x2	TBP 55	32	88	68	M8	18	940	95	148	0.92
M 60x2	TBP 60	32	98	73	M8	18	1 070	100	186	1.14
M 65x2	TBP 65	32	105	78	M8	18	1 155	120	196	1.29
M 70x2	TBP 70	35	110	85	M8	18	1 230	130	228	1.49
M 75x2	TBP 75	38	125	90	M10	32	1 300	150	255	2.25
M 80x2	TBP 80	38	140	95	M10	32	1 420	160	291	2.97
M 85x2	TBP 85	38	150	100	M10	32	1 510	190	315	3.44
M 90x2	TBP 90	38	155	110	M10	32	1 596	200	369	3.59
M 95x2	TBP 95	38	160	115	M10	32	1 656	220	391	3.73
M 100x2	TBP 100	40	160	120	M10	32	1 780	250	432	3.70
<hr/>										
M20x1	TBPR 20/1	20	38	28	M5	4	255	18	56	0.12
M20x1.5	TBPR 20/1.5	20	38	28	M5	4	225	18	56	0.12
M 25x1.5	TBPR 25	20	45	33	M6	8	405	25	85	0.17
M 30x1.5	TBPR 30	22	52	40	M6	8	491	32	96	0.24
M 35x1.5	TBPR 35	22	58	47	M6	8	560	40	107	0.28
M 40x1.5	TBPR 40	22	62	52	M8	14	585	55	127	0.29
M 45x1.5	TBPR 45	24	68	59	M8	14	641	65	149	0.37
M 50x1.5	TBPR 50	25	75	64	M8	14	706	85	180	0.46
M 55x2	TBPR 55	32	88	68	M8	14	940	95	206	0.92
M 60x2	TBPR 60	32	98	73	M8	14	1 070	100	255	1.14
M 65x2	TBPR 65	32	105	78	M8	14	1 155	120	277	1.29
M 70x2	TBPR 70	35	110	85	M8	14	1 230	130	304	1.49
M 75x2	TBPR 75	38	125	90	M10	26	1 300	150	357	2.25
M 80x2	TBPR 80	38	140	95	M10	26	1 420	160	396	2.97
M 85x2	TBPR 85	38	150	100	M10	26	1 510	190	444	3.44
M 90x2	TBPR 90	38	155	110	M10	26	1 596	200	501	3.59
M 95x2	TBPR 95	38	160	115	M10	26	1 656	220	550	3.73
M 100x2	TBPR 100	40	160	120	M10	26	1 780	250	603	3.70

Far: Ultimate axial load / Ma: Tightening torque / Md: Brake-away torque corresponding to indicated Ma

Mbl: Max. tightening torque recommended for attachment bolts / D1: Outer diameter / D3: Bearing face diameter / L1: Width

Snap ring

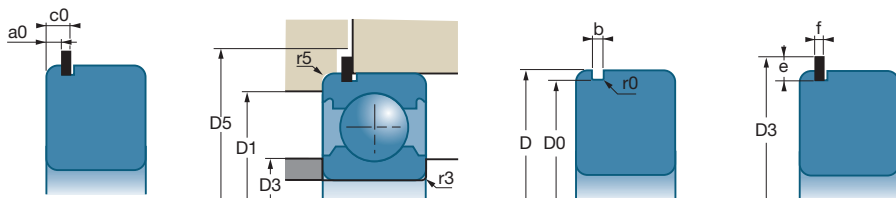

D	Ref.		a0		c0		D5	r5	d0	
			min	max	min	max			min	max
mm	mm	Reference	mm	mm	mm	mm	mm	mm	mm	mm
30	R30	6200	1.90	2.06	2.92	3.18	36.0	0.6	27.91	28.17
32	R32	6002	1.90	2.06	2.92	3.18	38.0	0.3	29.90	30.15
		6201	1.90	2.06	2.92	3.18	38.0	0.6	29.90	30.15
35	R35	6003	1.90	2.06	2.92	3.18	41.0	0.3	32.92	33.17
		6202-5202 6300	1.90	2.06	2.92	3.18	41.0	0.6	32.92	33.17
37	R37	6301	1.90	2.06	2.92	3.18	42.5	0.6	34.52	34.77
40	R40	6203-5203	1.90	2.06	2.92	3.18	46.5	0.6	37.85	38.10
42	R42	6004 6302	1.90	2.06	2.92	3.18	47.5	0.6	39.50	39.75
47	R47	6005	1.90	2.06	2.92	3.18	54.0	0.6	44.35	44.60
		6204-5204 6303-5303	2.31	2.46	3.33	3.58	54.0	0.6	44.35	44.60
50	R50	620/22	2.31	2.46	3.33	3.58	57.0	0.6	47.35	47.60
52	R52	6205-5205 6304-5304	2.31	2.46	3.33	3.58	59.0	0.6	49.48	49.73
55	R55	6006	1.88	2.08	2.90	3.20	62.0	0.6	52.35	52.60
62	R62	6007	1.88	2.08	3.48	3.78	69.0	0.6	59.11	59.61
		6206-5206 6305-5305 6403	3.07	3.28	4.67	4.98	69.0	0.6	59.11	59.61
68	R68	6008	2.29	2.49	3.89	4.19	76.0	0.6	64.31	64.82
72	R72	6207-5207 6306-5306 6404	3.07	3.28	4.67	4.98	80.0	0.6	68.30	68.81
75	R75	6009	2.29	2.49	3.89	4.19	83.0	0.6	71.32	71.83
80	R80	6010	2.29	2.49	3.89	4.19	88.0	0.6	76.30	76.81
		6208-5208 6307-5307 6405	3.07	3.28	4.67	4.98	88.0	0.6	76.30	76.81
85	R85	6209-5209	3.07	3.28	4.67	4.98	93.0	0.6	81.31	81.81
90	R90	6011	2.67	2.87	5.03	5.33	97.5	0.6	86.28	86.79
		6210-5210 6308-5308 6406	3.07	3.28	5.43	5.74	97.5	0.6	86.28	86.79

■ Snap ring

D	Ref.		b		r0	D3	e		f	
			min	max	min	max	min	max	min	max
mm	mm	Reference	mm	mm	mm	mm	mm	mm	mm	mm
30	R30	6200	1.35	1.65	0.4	34.7	3.1	3.25	1.02	1.12
32	R32	6002	1.35	1.65	0.4	36.7	3.1	3.25	1.02	1.12
		6201	1.35	1.65	0.4	36.7	3.1	3.25	1.02	1.12
35	R35	6003	1.35	1.65	0.4	39.7	3.1	3.25	1.02	1.12
		6202-5202 6300	1.35	1.65	0.4	39.7	3.1	3.25	1.02	1.12
37	R37	6301	1.35	1.65	0.4	41.3	3.1	3.25	1.02	1.12
40	R40	6203-5203	1.35	1.65	0.4	44.6	3.1	3.25	1.02	1.12
42	R42	6004 6302	1.35	1.65	0.4	46.3	3.1	3.25	1.02	1.12
47	R47	6005	1.35	1.65	0.4	52.7	3.89	4.04	1.02	1.12
		6204-5204 6303-5303	1.35	1.65	0.4	52.7	3.89	4.04	1.02	1.12
50	R50	620/22	1.35	1.65	0.4	55.7	3.89	4.04	1.02	1.12
52	R52	6205-5205 6304-5304	1.35	1.65	0.4	57.9	3.89	4.04	1.02	1.12
55	R55	6006	1.35	1.65	0.4	60.7	3.89	4.04	1.02	1.12
62	R62	6007	1.90	2.20	0.6	67.7	3.89	4.04	1.6	1.70
		6206-5206 6305-5305 6403	1.90	2.20	0.6	67.7	3.89	4.04	1.6	1.70
68	R68	6008	1.90	2.20	0.6	74.6	4.7	4.85	1.6	1.70
72	R72	6207-5207 6306-5306 6404	1.90	2.20	0.6	78.6	4.7	4.85	1.6	1.70
75	R75	6009	1.90	2.20	0.6	81.6	4.7	4.85	1.6	1.70
80	R80	6010	1.90	2.20	0.6	86.6	4.7	4.85	1.6	1.70
		6208-5208 6307-5307 6405	1.90	2.20	0.6	86.6	4.7	4.85	1.6	1.70
85	R85	6209-5209	1.90	2.20	0.6	91.6	4.7	4.85	1.6	1.70
90	R90	6011	2.70	3.00	0.6	96.5	4.7	4.85	2.36	2.46
		6210-5210 6308-5308 6406	2.70	3.00	0.6	96.5	4.7	4.85	2.36	2.46



Snap ring (continued)

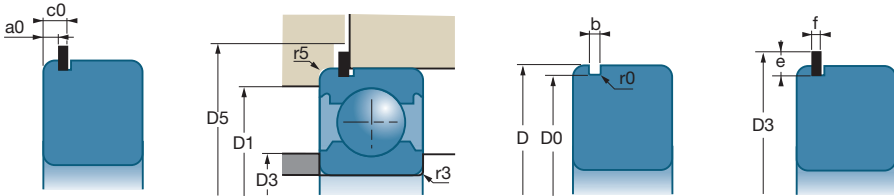

D	Ref.		a0		c0		D5	r5	d0	
			min	max	min	max			min	max
mm	mm	Reference	mm	mm	mm	mm	mm	mm	mm	mm
95	R95	6012	2.67	2.87	5.03	5.33	103.0	0.6	91.31	91.82
100	R100	6013	2.67	2.87	5.03	5.33	107.5	0.6	96.29	96.80
		6211-5211 6309-5309 6407	3.07	3.28	5.43	5.74	107.5	0.6	96.29	96.80
110	R110	6014	2.67	2.87	5.03	5.33	117.5	0.6	106.30	106.81
		6212-5212 6310-5310 6408	3.07	3.28	5.43	5.74	118.0	0.6	106.30	106.81
115	R115	6015	2.67	2.87	5.03	5.33	123.0	0.6	111.30	111.81
120	R120	6213-5213 6311-5311 6409	3.86	4.06	6.58	6.88	131.0	0.6	114.71	115.21
125	R125	6016	2.67	2.87	5.39	5.69	136.0	0.6	119.71	120.22
		6214-5214	3.86	4.06	6.58	6.88	136.0	0.6	119.71	120.22
130	R130	6017	2.67	2.87	5.39	5.69	141.0	0.6	124.71	125.22
		6215 6312-5312 6410	3.86	4.06	5.58	6.88	141.0	0.6	124.71	125.22
140	R140	6018	3.45	3.71	6.17	6.53	151.0	0.6	134.72	135.23
		6216 6313-5313 6411	4.65	4.90	7.37	7.72	151.0	0.6	134.72	135.23
145	R145	6019	3.45	3.71	6.17	6.53	156.0	0.6	139.73	140.23
150	R150	6020	3.45	3.71	6.17	6.53	161.0	0.6	144.73	145.24
		6217 6314 6412	4.65	4.90	7.37	7.72	161.0	0.6	144.73	145.24
160	R160	6021	3.45	3.71	6.17	6.53	171.0	0.6	154.71	155.22
		6218 6315 6413	4.65	4.90	7.37	7.72	171.0	0.6	154.71	155.22
170	R170	6022	3.45	3.71	6.45	6.81	184.0	0.6	163.14	163.65
		6219 6316	5.44	5.69	8.44	8.79	184.0	0.6	163.14	163.65
180	R180	6024	3.45	3.71	6.45	6.81	194.0	0.6	173.15	173.66
		6220 6317 6414	5.44	5.69	8.44	8.79	194.0	0.6	173.15	173.66
190	R190	6221 6318 6415	5.44	5.69	8.44	8.79	204.0	0.6	183.13	183.64
200	R200	6026 6222 6319 6416	5.44	5.69	8.44	8.79	214.0	0.6	193.14	193.65

■ Snap ring (continued)

D	Ref.		b		r0	D3	e		f	
			min	max	min	max	min	max	min	max
mm	mm	Reference	mm	mm	mm	mm	mm	mm	mm	mm
95	R95	6012	2.70	3.00	0.6	101.6	4.7	4.85	2.36	2.46
100	R100	6013	2.70	3.00	0.6	106.5	4.7	4.85	2.36	2.46
		6211-5211 6309-5309 6407	2.70	3.00	0.6	106.5	4.7	4.85	2.36	2.46
110	R110	6014	2.70	3.00	0.6	116.6	4.7	4.85	2.36	2.46
		6212-5212 6310-5310 6408	2.70	3.00	0.6	116.6	4.7	4.85	2.36	2.46
115	R115	6015	2.70	3.00	0.6	121.6	4.7	4.85	2.36	2.46
120	R120	6213-5213 6311-5311 6409	3.10	3.40	0.6	129.7	7.06	7.21	2.72	2.82
125	R125	6016	3.10	3.40	0.6	134.7	7.06	7.21	2.72	2.82
		6214-5214	3.10	3.40	0.6	134.7	7.06	7.21	2.72	2.82
130	R130	6017	3.10	3.40	0.6	139.7	7.06	7.21	2.72	2.82
		6215 6312-5312 6410	3.10	3.40	0.6	139.7	7.06	7.21	2.72	2.82
140	R140	6018	3.10	3.40	0.6	149.7	7.06	7.21	2.72	2.82
		6216 6313-5313 6411	3.10	3.40	0.6	149.7	7.06	7.21	2.72	2.82
145	R145	6019	3.10	3.40	0.6	154.7	7.06	7.21	2.72	2.82
150	R150	6020	3.10	3.40	0.6	159.7	7.06	7.21	2.72	2.82
		6217 6314 6412	3.10	3.40	0.6	159.7	7.06	7.21	2.72	2.82
160	R160	6021	3.10	3.40	0.6	169.7	7.06	7.21	2.72	2.82
		6218 6315 6413	3.10	3.40	0.6	169.7	7.06	7.21	2.72	2.82
170	R170	6022	3.50	3.80	0.6	182.9	9.45	9.6	3.00	3.10
		6219 6316	3.50	3.80	0.6	182.9	9.45	9.6	3.00	3.10
180	R180	6024	3.50	3.80	0.6	192.9	9.45	9.6	3.00	3.10
		6220 6317 6414	3.50	3.80	0.6	192.9	9.45	9.6	3.00	3.10
190	R190	6221 6318 6415	3.50	3.80	0.6	202.9	9.45	9.6	3.00	3.10
200	R200	6026 6222 6319 6416	3.50	3.80	0.6	212.9	9.45	9.6	3.00	3.10



Self-aligning bearing units

■ Definition and capabilities	422
■ Materials and surfaces	422
■ Options for shaft fixing	424
■ Fixing to the shaft / Admissible speed limits	425
■ Sealing systems	426
■ Relubrication system	427
■ Grease	427
■ Series	428
■ Variants / Product index	429
■ Installation / Assembly criteria	430
■ Prefixes and suffixes	431
■ Dimension tables	432
<i>Self-aligning bearing units with cast iron or pressed steel housing</i>	432
<i>Self-aligning bearing units with stainless steel housing</i>	612
<i>Self-aligning bearing units with thermoplastic housing</i>	636



Definition and capabilities

Used in highly diversified industrial sectors, self-aligning bearing units sustain, by their design, high loads where alignment is not guaranteed. The easy way of mounting, the nearly maintenance-free operation and the low requirements to the mating structure (compensation of misalignments) enable uncomplicated constructions in economical terms.

For more than 35 years, SNR has accumulated a significant experience in the various applications in mechanical construction and technological installation sectors.

With more than 25.000 possible combinations of bearing units the SNR range is one of the most extensive on the market.

The bearing units are separated into housings from:

- Grey cast iron
- Pressed steel
- Stainless steel
- Thermoplastic

The bearing inserts differ in their shaft locking arrangements in fixation by:

- Set screws
- Eccentric locking collar
- Adapter sleeve
- Tight fit

The choice of sealing systems depends on their application. SNR inserts can be equipped with various seals to provide the best effect in almost every situation.

For use in corrosive environments our inserts can be protected by a special surface treatment. As well as SNR is able to deliver inserts for inch shafts.

Included in this product line is a range of covers from stainless steel which provides an additional security to the operation of the bearings.

The self-aligning bearing units from grey cast iron are manufactured according the ISO norm or JIS norm (Japanese Industry Standard).

Materials and Surfaces



■ SNR - grey cast iron housings

Quality grey cast FG20 or FG25. Passivated material with painted surfaces (tone RAL 5010).



■ SNR - Stainless steel housings

Solid cast housings from stainless steel with smooth surface. Material AISI 304 (X5CrNi 1810).



■ SNR - Pressed steel housings

Housings made from cold rolled sheet steel with zinc-plated surfaces.



■ SNR - Thermoplastic Housings

Solid housings from thermoplastic resin (PBT). The specific resin, the design and the smooth surfaces are the crucial factors which effect a good protection against bacterial contamination.

Bearing inserts			
Cast iron	Pressed steel	Stainless steel	Thermoplastic
<p>Single row radial contact self-aligning bearing inserts from steel 100Cr6 with spherical outer ring and extended inner ring. Relubricatable (Suffix G2).</p> <p>Riveted two-piece sheet steel cage. Radial clearance C3 (high and low temperature inserts design T20 / T04 with C4). Sealed and protected by additional slingers (UC-EX-UK), or sealed without additional slingers (US – ES – CS). Series metric or inch.</p> <p>Fixing to the shaft by means of:</p> <ul style="list-style-type: none"> - Set screws - Eccentric locking collar - Adapter sleeve - Tight fit (CS, non-relubricatable) 		<p>Single row radial contact self-aligning bearing inserts from stainless steel AISI 440C with spherical outer ring and extended inner ring.</p> <p>Relubricatable. Cage from stainless steel. Radial clearance C3.</p> <p>Sealed with stainless steel washer with silicon rubber and additional stainless steel slingers (SUC).</p> <p>Pre-lubricated with grease for food applications (according USDA-H1).</p> <p>Fixing to the shaft by means of:</p> <ul style="list-style-type: none"> - Set screws - Eccentric locking collar 	

Grease fittings			
Cast iron	Pressed steel	Stainless steel	Thermoplastic
<p>Equipped in standard with a zinc-plated grease fitting (included in packaging)</p>	<p>Without relubrication facility.</p>	<p>Equipped in standard with a stainless steel grease fitting (mounted).</p>	<p>Equipped in standard with a stainless steel grease fitting (mounted).</p>

Protective caps			
Cast iron	Pressed steel	Stainless steel	Thermoplastic
<p>Open or closed protective caps made of stainless steel. Suffix open design CO or COE, closed design CC or CCE. 1 or 2 grooves are needed to mount the covers (flanged units 1; pillow blocks 2). Grooves are not manufactured as standard. Units with groove have the suffix N.</p>	<p>No protective caps available.</p>	<p>Open or closed protective caps made of stainless steel. Suffix open design CO or COE, closed design CC or CCE. 1 or 2 grooves are needed to mount the covers (flanged units 1; pillow blocks 2). Grooves are not manufactured as standard. Units with groove have the suffix N.</p>	<p>Open or closed protective caps made of plastic. Open design CV, closed design CF.</p>

Other versions			
Cast iron	Pressed steel	Stainless steel	Thermoplastic
<p>Cast iron housing: Surface treatment: zinc-plating (suffix PZ) or nickel-plating (suffix PN). Special design on demand.</p>			
<p>Bearing inserts from chrome steel 100Cr6: Available ex-factory:</p> <ul style="list-style-type: none"> - with 3-lip sealing system (suffix L3) - with combined sealing system axial-radial lips (suffix L4) - for high operating temperatures up to +200 °C (suffix T20) - for low operating temperatures up to -40 °C (suffix T04) - light-weight design of adapter sleeve version (prefix LK) - with cylindrical outer ring (series CUC-CUS-CES-CEX) 			



Options for shaft fixing

Fixing	Features	Application	
Hexagon socket set screw	<ul style="list-style-type: none"> • 2 set screws displaced by 120° with hexagon socket and knurled cup point 	<ul style="list-style-type: none"> • normal loads • low to medium speeds • easy to disassemble 	
Eccentric locking collar	<ul style="list-style-type: none"> • Fixing using an eccentric locking collar and hexagon socket set screw 	<ul style="list-style-type: none"> • normal loads with consistent direction of rotation • not suitable for reversing operation • low to medium speeds 	
Adapter sleeve	<ul style="list-style-type: none"> • Tapered adapter sleeve with lock washer and groove nut • Concentric shaft fixing 	<ul style="list-style-type: none"> • higher speeds • suitable for reversing operation • particularly smooth running 	
Fit adjustment	<ul style="list-style-type: none"> • Fixing using shaft fit adjustment 	<ul style="list-style-type: none"> • medium to high speeds • normal to high loads • little structural space 	
Floating bearing screw	<ul style="list-style-type: none"> • Stud bolt in shaft slot, can be moved in the axial direction 	<ul style="list-style-type: none"> • low speeds and loads • large degree of linear expansion (e.g., due to variable temperatures) 	

Fixing to the shaft / Admissible speed limits

One advantage of the SNR ball bearing units are the minimum demands that this type of bearing arrangement makes on the shaft. It must neither be hardened nor ground and the surface quality too has few requirements. We recommend shaft materials having tensile strength of at least 500 N/mm². The maximal admissible speed is depending not only on the bearing geometry but also on the tolerance of the shaft diameter, as can be seen in the following diagram.

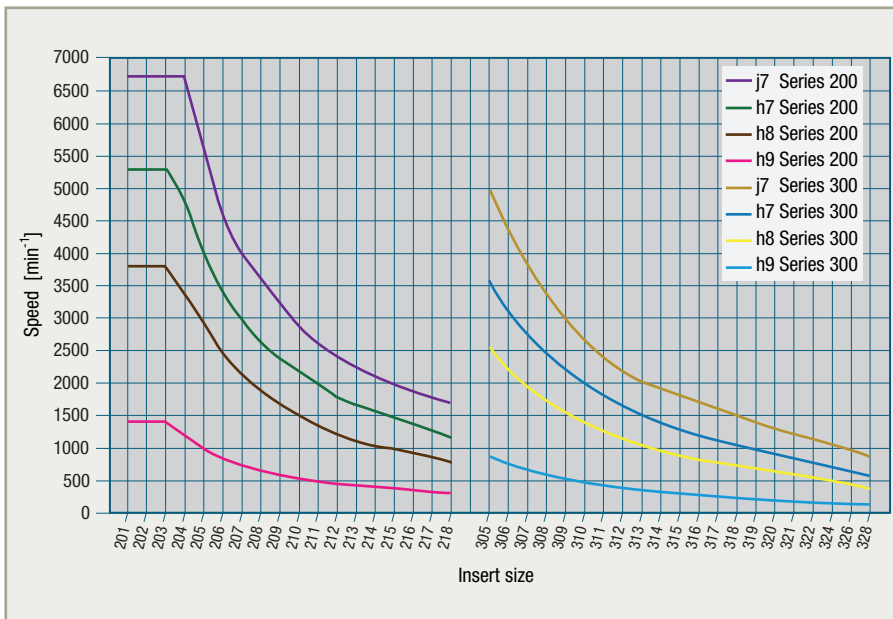

For most applications, threaded pins provide a sufficiently secure fixing of the inner ring to the shaft. For eccentric locking collars, it is recommended to use shafts manufactured according to **h6-h9** for the bearing seats. If tapered adapter sleeves are used, the shaft tolerance **h9** to **h11** is sufficient. If severe operating conditions are encountered, such as vibrations or shocks, a slight interference fit is preferred.

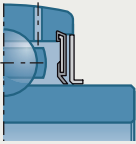
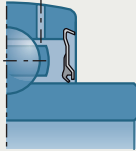
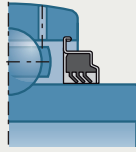
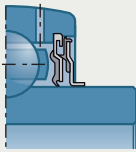
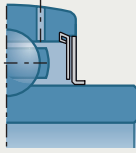

Sealing systems

Description	Application	
<p>Seal with slinger</p> <p>Two-part sealing system consisting of sheet metal washer with vulcanised single lip seal of nitrile rubber (NBR) and additional sheet metal slinger.</p>	<ul style="list-style-type: none"> • Additional mechanical protection of the seal, from contamination. • Medium to high speeds 	
<p>Single lip seal</p> <p>Seal consisting of sheet metal washer with vulcanised single lip seal of nitrile rubber (NBR)</p>	<ul style="list-style-type: none"> • Normal ambient conditions • Medium to high speeds 	
<p>Triple lip seal</p> <p>One-part sealing system consisting of sheet metal washer with vulcanised triple lip seal of nitrile rubber (NBR)</p>	<ul style="list-style-type: none"> • For strong contaminated environments • Low to medium speeds 	
<p>L4 – sealing system</p> <p>Two-part sealing system consisting of an internal sheet metal washer with vulcanised lip seal (radial at inner ring) and an external sheet metal washer with a radial seal to the outer ring and an internal axial seal to the internal washer.</p>	<ul style="list-style-type: none"> • Rough environmental conditions • Medium speeds 	
<p>High temperature seal</p> <p>Non-contacting labyrinth system consisting from two sheet metal washers.</p>	<ul style="list-style-type: none"> • High temperature operating up to +200 °C 	

Relubrication system

Grey cast iron housings are equipped with a lubrication groove within the spherical bore. The inserts have 4 lubrication holes in the outer ring which are arranged offset.

Because of the arrangement of the lubrication holes, SNR inserts can be mounted in nearly all housings with lubrication groove and then be relubricated.

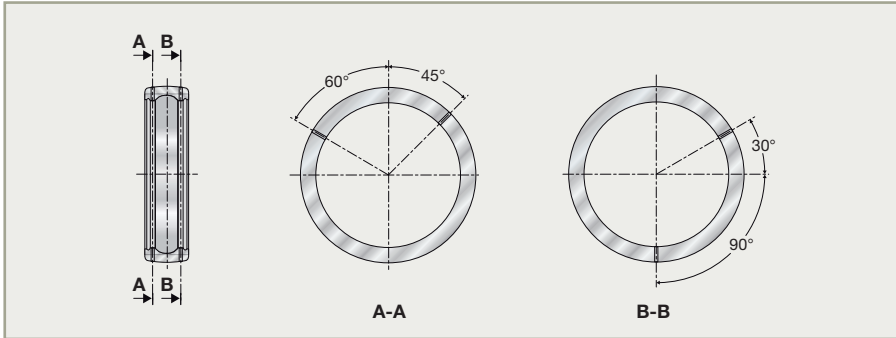

Grease

SNR ball bearing inserts are lubricated for life ex factory. If relubrication is necessary because of severe operating condition, a grease with the same base and consistency should be used.

The greases for SNR ball bearing units have the following technical characteristics:

Range of application for grease	Grease base	Temperature range [°C]	Consistency DIN 51 818 NLGI class	Speed characteristic (n • dm) [min ⁻¹ • mm]	Viscosity at 40°C [mm ² /s]
Standard	Lithium soap	-20 to +120	II	500 000	100
High temperatures (e.g., "T20")	Perfluor-polyether oil and PTFE	-40 to +260	II	300 000	400
Low temperatures (e.g., "T04")	Lithium soap	-60 to +120	III	–	25



Series

Housings		Inserts	UC200	UC300	SUC200	MUC200	US200	ES200
Pillow blocks	Cast iron	PE	UCPE				USPE	ESPE
		PLE	UCPLE				USPLE	ESPLE
		P	UCP	UCP			USP	ESP
		PH	UCPH				USPH	ESPH
		PAE	UCPAE				USPAE	ESPAE
		PG	UCPG				USPG	ESPG
		PA	UCPA				USPA	ESPA
	Pressed steel	PP					USPP	ESPP
	Stainless steel	SP			SUCP			
		SPA			SUCPA			
Thermoplastic	GNP				GNP			

Flanged units	Cast iron	FE	UCFE				USFE	ESFE
		F	UCF	UCF			USF	ESF
		FS		UCFS				
		FCE	UCFCE				USFCE	ESFCE
		FC	UCFC				USFCE	ESFCE
		FEE					USFEE	ESFEE
		FTE					USFTE	ESFTE
		FLE	UCFLE				USFLE	ESFLE
		FL	UCFL	UCFL			USFL	ESFL
		FLZ	UCFLZ				USFLZ	ESFLZ
		FD					USFD	ESFD
		FAE					USFAE	ESFAE
	FA	UCFA				USFA	ESFA	
	Pressed steel	PF					USPF	ESPF
		PFL					USPFL	ESPFL
		PFT					USPFT	ESPFT
		PFE					USPFE	ESPFE
	Stainless steel	SF			SUCF			
		SFL			SUCFL			
	Thermoplastic	GSF				GSF		
GSFT					GSFT			

Take-up, cartridge- and hanger units	Cast iron	T	UCT	UCT			UST	EST
		T+WB	UCT+WB				UST+WB	EST+WB
		SP	UCSP				USSP	ESSP
		C	UCC	UCC			USC	ESC
		EHE	UCEHE				USEHE	ESEHE
	Stainless steel	ST			SUCT			

SES200	EX200	EX300	UK200+H	UK300+H	Protection caps	Housings	
	EXPE		UKPE+H		CC,CCE/CO,COE	PE	Cast iron
	EXPLE		UKPLE+H		CC,CCE/CO,COE	PLE	
	EXP	EXP	UKP+H	UKP+H	CC,CCE/CO,COE	P	
	EXPH		UKPH+H		CC,CCE/CO,COE	PH	
	EXPAE		UKPAE+H		CC,CCE/CO,COE	PAE	
	EXPG		UKPG+H		CC,CCE/CO,COE	PG	
	EXPA		UKPA+H		CC,CCE/CO,COE	PA	Pressed steel
						PP	
SESP					CC,CCE/CO,COE	SP	Stainless steel
SESPA					CC,CCE/CO,COE	SPA	Stainless steel
					CF/CV	GNP	Thermoplastic

Pillow blocks

	EXFE		UKFE+H		CC,CCE/CO,COE	FE	Cast iron
	EXF	EXF	UKF+H	UKF+H	CC,CCE/CO,COE	F	
		EXFS		UKFS+H		FS	
	EXFCE		UKFCE+H			FCE	
	EXFC		UKFC+H		CC,CCE/CO,COE	FC	
						FEE	
						FTE	
	EXFLE		UKFLE+H		CC,CCE/CO,COE	FLE	
	EXFL	EXFL	UKFL+H	UKFL+H	CC,CCE/CO,COE	FL	
	EXFLZ		UKFLZ+H			FLZ	
						FD	Flanged units
						FAE	
	EXFA		UKFA+H		CC,CCE/CO,COE	FA	
						PF	
						PFL	
						PFT	
						PFE	
SESF					CC,CCE/CO,COE	SF	
SESFL					CC,CCE/CO,COE	SFL	
					CF/CV	GSF	
					CF/CV	GSFT	

Pressed steel

Stainless steel

Thermoplastic

	EXT		UKT+H	UKT+H	CC,CCE/CO,COE	T	Cast iron
	EXT+WB		UKT+H+WB		CC,CCE/CO,COE	T+WB	
	EXSP		UKSP+H		CC,CCE/CO,COE	SP	
	EXC	EXC	UKC+H	UKC+H		C	
	EXEHE		UKEHE+H			EHE	Stainless steel
SEST					CC,CCE/CO,COE	ST	

Take-up, cartridge- and hanger units



Variants / Product index

Design (page)	UC200 (P. 566)	UC300 (P. 578)	SUC200 (P. 632)	MUC200 (P. 640)	US200 (P. 568)	ES200 (P. 570)
Design (page)	PE (P. 432)	PLE (P. 438)	P (P. 442)	PH (P. 450)	PAE (P. 454)	
Design (page)	FE (P. 466)	F (P. 472)	FS (P. 494)	FCE (P. 480)	FC (P. 486)	
Design (page)	FD (P. 516)	FAE (P. 518)	FA (P. 520)	PF (P. 558)	PFL (P. 560)	PFT (P. 562)
Design (page)	T (P. 524)	T+WB (P. 534)	SP (P. 538)			

Installation/assembly criteria

■ Misalignment

SNR bearings units are self-aligning, due to their spherical bearing seat. The mounted insert allows an angular movement in all directions. That is why shaft misalignment is compensated up to a certain degree.

This self-alignment **should** only be necessary once, and must not occur permanently in operation.

If bearing unit should be relubricated: $\alpha = \pm 2^\circ$

If bearing unit should not be relubricated: $\alpha = \pm 5^\circ$

Bearings units with protective caps: $\alpha = \pm 1^\circ$

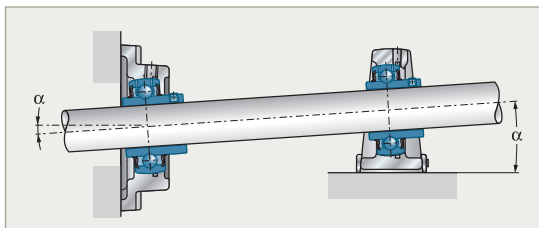

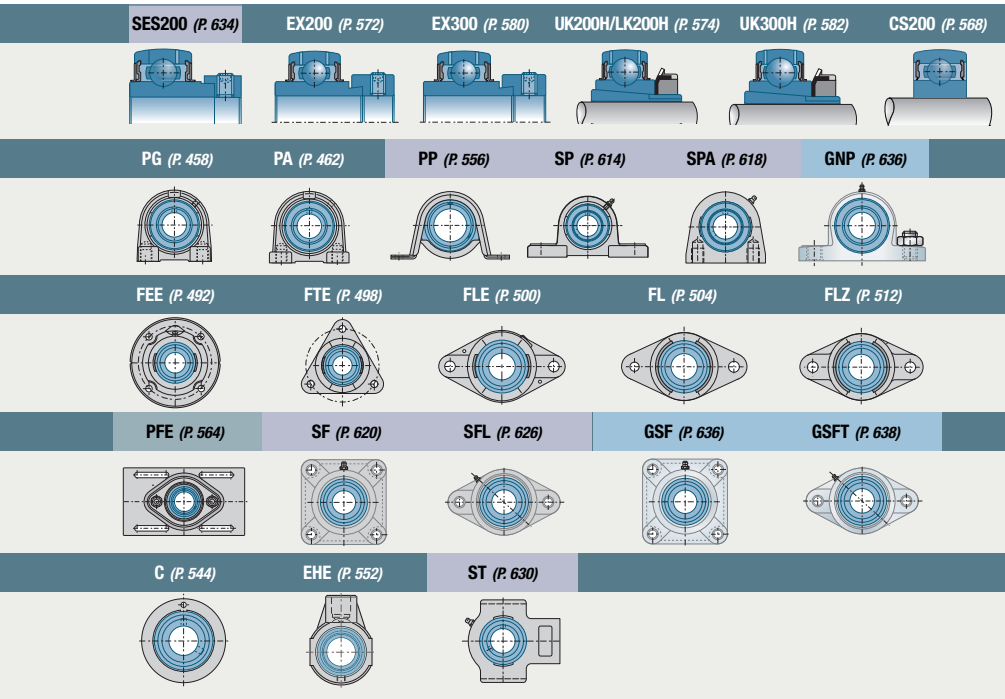

Bearing units with grey cast housings
 Bearing units with pressed steel housings
 Bearing units with stainless steel housings
 Bearing units with thermoplastic housings



Prefixes and suffixes

CC	Closed protective cap made of stainless steel
CO	Open protective cap made of stainless steel with double lip seal
G2	SNR relubrication system
H	Adapter sleeve for bearing inserts with tapered bore
M	Flanged housing with threaded mounting bores (metric)
N	Groove(s) in housing for fixing protective caps
PN	Nickel-plated housing surface
PZ	Zinc-plated housing surface
S	Material stainless steel (Prefix)



Self-aligning bearing units with cast iron or pressed steel housing

→ Pillow block unit

PE200

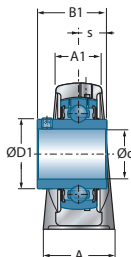
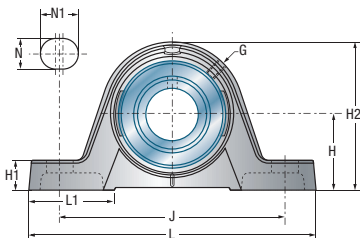
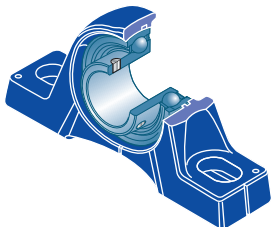

UCPE200

Shaft diameter		Unit		Main dimensions [mm]												
d mm		L	H	A1	A	J	N	N1	L1	H1	H2	s1	B	B1	s	
12	UCPE201	130	33,3	19	32	97	11	19	40,0	14,5	64	-	-	31,0	12,7	
	USPE201	125	30,2	18	30	95	11	19	38,0	10,0	57	-	-	22,0	6,0	
	ESPE201	125	30,2	18	30	95	11	19	38,0	10,0	57	-	-	28,6	6,5	
	EXPE201	130	33,3	19	32	97	11	19	40,0	14,5	64	-	-	43,5	17,0	
15	UCPE202	130	33,3	19	32	97	11	19	40,0	14,5	64	-	-	31,0	12,7	
	USPE202	125	30,2	18	30	95	11	19	38,0	10,0	57	-	-	22,0	6,0	
	ESPE202	125	30,2	18	30	95	11	19	38,0	10,0	57	-	-	28,6	6,5	
	EXPE202	130	33,3	19	32	97	11	19	40,0	14,5	64	-	-	43,5	17,0	
17	UCPE203	130	33,3	19	32	97	11	19	40,0	14,5	64	-	-	31,0	12,7	
	USPE203	125	30,2	18	30	95	11	19	38,0	10,0	57	-	-	22,0	6,0	
	ESPE203	125	30,2	18	30	95	11	19	38,0	10,0	57	-	-	28,6	6,5	
	EXPE203	130	33,3	19	32	97	11	19	40,0	14,5	64	-	-	43,5	17,0	
20	UCPE204	130	33,3	19	32	97	11	19	40,0	14,5	64	-	-	31,0	12,7	
	USPE204	130	33,3	19	32	97	11	19	40,0	14,5	64	-	-	25,0	7,0	
	ESPE204	130	33,3	19	32	97	11	19	40,0	14,5	64	-	-	30,9	7,5	
	EXPE204	130	33,3	19	32	97	11	19	40,0	14,5	64	-	-	43,5	17,0	
	UKPE205H	130	36,5	21	36	103	11	19	39,0	14,5	70	18,5	35	-	-	
25	UCPE205	130	36,5	21	36	103	11	19	39,0	14,5	70	-	-	34,0	14,3	
	USPE205	130	36,5	21	36	103	11	19	39,0	14,5	70	-	-	27,0	7,5	
	ESPE205	130	36,5	21	36	103	11	19	39,0	14,5	70	-	-	30,9	7,5	
	EXPE205	130	36,5	21	36	103	11	19	39,0	14,5	70	-	-	44,3	17,4	
	UKPE206H	158	42,9	25	40	118	14	22	47,0	17,0	82	20,5	38	-	-	
30	UCPE206	158	42,9	25	40	118	14	22	47,0	17,0	82	-	-	38,1	15,9	
	USPE206	158	42,9	25	40	118	14	22	47,0	17,0	82	-	-	30,0	8,0	
	ESPE206	158	42,9	25	40	118	14	22	47,0	17,0	82	-	-	35,7	9,0	
	EXPE206	158	42,9	25	40	118	14	22	47,0	17,0	82	-	-	48,3	18,2	
	UKPE207H	163	47,6	27	45	126	14	21	49,0	19,0	93	22,5	43	-	-	
35	UCPE207	163	47,6	27	45	126	14	21	49,0	19,0	93	-	-	42,9	17,5	
	USPE207	163	47,6	27	45	126	14	21	49,0	19,0	93	-	-	32,0	8,5	
	ESPE207	163	47,6	27	45	126	14	21	49,0	19,0	93	-	-	38,9	9,5	
	EXPE207	163	47,6	27	45	126	14	21	49,0	19,0	93	-	-	51,1	18,8	
	UKPE208H	179	49,2	30	48	138	14	26	53,0	19,0	99	24,5	46	-	-	

* = equipped with two open protective caps for passing shafts; suffix CO or COE
 ** = equipped with one open and one closed protective cap for shaft ends; suffix CC or CCE

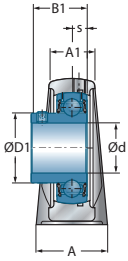

USPE200

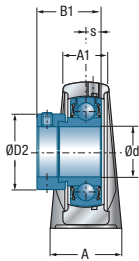

ESPE200

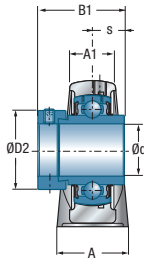

EXPE200

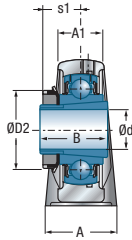

UKPE200H

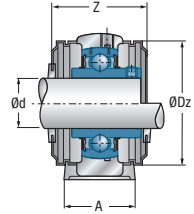

UCPE200CO(CC)

Main dimensions [mm]

Main dimensions [mm]					Housing	Bearing insert	Open protective cap*	Closed protective cap**	Dynamic load rating	Static load rating	Weight	Shaft diameter
D1	D2	G	Z	Dz					C _r [kN]	C _{0r} [kN]	kg	d mm
29,0	-	R1/8"	44,6	54,0	PE204	UC201G2	CO	CC	12,80	6,65	0,5	12
24,6	-	M6x1	40,6	46,0	PE203	US201G2	CO	CC	9,55	4,78	0,4	
-	28,6	M6x1	54,0	46,0	PE203	ES201G2	COE	CCE	9,55	4,78	0,5	
-	33,3	R1/8"	63,0	54,0	PE204	EX201G2	COE	CCE	12,80	6,65	0,6	
29,0	-	R1/8"	44,6	54,0	PE204	UC202G2	CO	CC	12,80	6,65	0,5	15
24,6	-	M6x1	40,6	46,0	PE203	US202G2	CO	CC	9,55	4,78	0,4	
-	28,6	M6x1	54,0	46,0	PE203	ES202G2	COE	CCE	9,55	4,78	0,5	
-	33,3	R1/8"	63,0	54,0	PE204	EX202G2	COE	CCE	12,80	6,65	0,6	
29,0	-	R1/8"	44,6	54,0	PE204	UC203G2	CO	CC	12,80	6,65	0,5	17
24,6	-	M6x1	40,6	46,0	PE203	US203G2	CO	CC	9,55	4,78	0,4	
-	28,6	M6x1	54,0	46,0	PE203	ES203G2	COE	CCE	9,55	4,78	0,5	
-	33,3	R1/8"	63,0	54,0	PE204	EX203G2	COE	CCE	12,80	6,65	0,6	
29,0	-	R1/8"	44,6	54,0	PE204	UC204G2	CO	CC	12,80	6,65	0,5	20
29,0	-	R1/8"	44,6	54,0	PE204	US204G2	CO	CC	12,80	6,65	0,5	
-	33,3	R1/8"	63,0	54,0	PE204	ES204G2	COE	CCE	12,80	6,65	0,5	
-	33,3	R1/8"	63,0	54,0	PE204	EX204G2	COE	CCE	12,80	6,65	0,6	
-	38,0	R1/8"	47,8	60,0	PE205	UK205G2H	CO	CC	14,00	7,88	0,8	
34,0	-	R1/8"	47,8	60,0	PE205	UC205G2	CO	CC	14,00	7,88	0,7	25
34,0	-	R1/8"	47,8	60,0	PE205	US205G2	CO	CC	14,00	7,88	0,7	
-	38,1	R1/8"	65,0	60,0	PE205	ES205G2	COE	CCE	14,00	7,88	0,7	
-	38,1	R1/8"	65,0	60,0	PE205	EX205G2	COE	CCE	14,00	7,88	0,8	
-	45,0	R1/8"	52,8	70,0	PE206	UK206G2H	CO	CC	19,50	11,20	1,2	
40,3	-	R1/8"	52,8	70,0	PE206	UC206G2	CO	CC	19,50	11,20	1,1	30
40,3	-	R1/8"	52,8	70,0	PE206	US206G2	CO	CC	19,50	11,20	1,1	
-	44,5	R1/8"	71,0	70,0	PE206	ES206G2	COE	CCE	19,50	11,20	1,1	
-	44,5	R1/8"	71,0	70,0	PE206	EX206G2	COE	CCE	19,50	11,20	1,2	
-	52,0	R1/8"	57,4	80,0	PE207	UK207G2H	CO	CC	25,70	15,20	1,6	
48,0	-	R1/8"	57,4	80,0	PE207	UC207G2	CO	CC	25,70	15,20	1,5	35
48,0	-	R1/8"	57,4	80,0	PE207	US207G2	CO	CC	25,70	15,20	1,5	
-	55,6	R1/8"	76,0	80,0	PE207	ES207G2	COE	CCE	25,70	15,20	1,6	
-	55,6	R1/8"	76,0	80,0	PE207	EX207G2	COE	CCE	25,70	15,20	1,7	
-	58,0	R1/8"	66,8	88,0	PE208	UK208G2H	CO	CC	29,60	18,20	1,9	





→ Pillow block unit

PE200

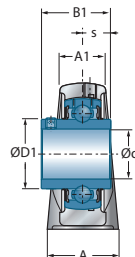
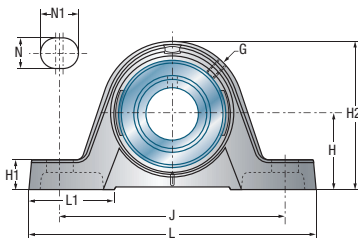
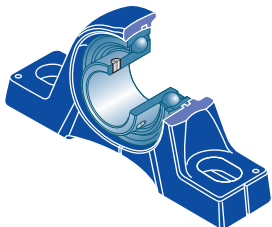

UCPE200

Shaft diameter		Unit		Main dimensions [mm]													
d mm		L	H	A1	A	J	N	N1	L1	H1	H2	s1	B	B1	s		
40	UCPE208	179	49,2	30	48	138	14	26	53,0	19,0	99	-	-	49,2	19,0		
	USPE208	179	49,2	30	48	138	14	26	53,0	19,0	99	-	-	34,0	9,0		
	ESPE208	179	49,2	30	48	138	14	26	53,0	19,0	99	-	-	43,7	11,0		
	EXPE208	179	49,2	30	48	138	14	26	53,0	19,0	99	-	-	56,3	21,4		
	UKPE209H	192	54,0	32	48	150	14	29	54,5	21,5	107	26,0	50	-	-		
45	UCPE209	192	54,0	32	48	150	14	29	54,5	21,5	107,0	-	-	49,2	19,0		
	USPE209	192	54,0	32	48	150	14	29	54,5	21,5	107,0	-	-	41,2	10,2		
	ESPE209	192	54,0	32	48	150	14	29	54,5	21,5	107,0	-	-	43,7	11,0		
	EXPE209	192	54,0	32	48	150	14	29	54,5	21,5	107,0	-	-	56,3	21,4		
	UKPE210H	200	57,2	34	54	158	18	23	61,0	21,5	115,0	27,5	55,0	-	-		
50	UCPE210	200	57,2	34	54	158	18	23	61,0	21,5	115,0	-	-	51,6	19,0		
	USPE210	200	57,2	34	54	158	18	23	61,0	21,5	115,0	-	-	43,5	10,9		
	ESPE210	200	57,2	34	54	158	18	23	61,0	21,5	115,0	-	-	43,7	11,0		
	EXPE210	200	57,2	34	54	158	18	23	61,0	21,5	115,0	-	-	62,7	24,6		
	UKPE211H	222	63,5	35	60	176	18	30	68,0	22,5	124,5	29,0	59,0	-	-		
55	UCPE211	222	63,5	35	60	176	18	30	68,0	22,5	124,5	-	-	55,6	22,2		
	USPE211	222	63,5	35	60	176	18	30	68,0	22,5	124,5	-	-	45,3	11,8		
	ESPE211	222	63,5	35	60	176	18	30	68,0	22,5	124,5	-	-	48,4	12,0		
	EXPE211	222	63,5	35	60	176	18	30	68,0	22,5	124,5	-	-	71,3	27,7		
60	UCPE212	240	69,9	42	60	190	18	28	71,0	25,0	140,0	-	-	65,1	25,4		
	USPE212	240	69,9	42	60	190	18	28	71,0	25,0	140,0	-	-	53,7	14,9		
	ESPE212	240	69,9	42	60	190	18	28	71,0	25,0	140,0	-	-	49,3	12,0		
	EXPE212	240	69,9	42	60	190	18	28	71,0	25,0	140,0	-	-	77,7	30,9		
	UKPE213H	260	79,4	44	65	203	22	28	77,0	27,5	156,0	32,0	65,0	-	-		
65	UCPE213	260	79,4	44	65	203	22	28	77,0	27,5	156,0	-	-	65,1	25,4		
	EXPE213	260	79,4	44	65	203	22	28	77,0	27,5	156,0	-	-	85,7	34,1		
	UKPE215H	265	82,5	48	66	210	22	30	78,0	27,5	164,0	35,5	73,0	-	-		
70	UCPE214	260	79,4	44	65	203	22	28	77,0	27,5	156,0	-	-	74,6	30,2		
	EXPE214	260	79,4	44	65	203	22	28	77,0	27,5	156,0	-	-	85,7	34,1		
	UKPE216H	290	89,0	55	78	232	26	34	90,0	30,0	175,0	39,0	78,0	-	-		

* = equipped with two open protective caps for passing shafts; suffix CO or COE
 ** = equipped with one open and one closed protective cap for shaft ends; suffix CC or CCE

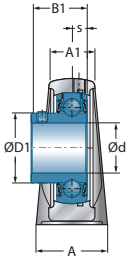

USPE200

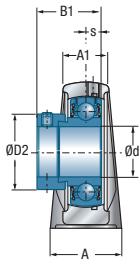

ESPE200

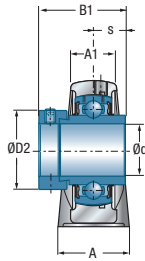

EXPE200

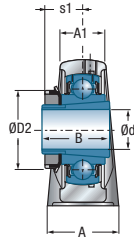

UKPE200H

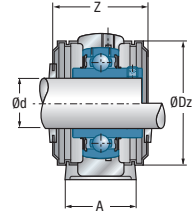

UCPE200CO(CC)

Main dimensions [mm]

Main dimensions [mm]					Housing	Bearing insert	Open protective cap*	Closed protective cap**	Dynamic load rating	Static load rating	Weight	Shaft diameter
D1	D2	G	Z	Dz					C_r [kN]	C_{Or} [kN]	kg	d mm
53,0	-	R1/8"	66,8	88,0	PE208	UC208G2	CO	CC	29,60	18,20	1,8	40
53,0	-	R1/8"	66,8	88,0	PE208	US208G2	CO	CC	29,60	18,20	1,8	
-	60,3	R1/8"	79,0	88,0	PE208	ES208G2	COE	CCE	29,60	18,20	1,8	
-	60,3	R1/8"	79,0	88,0	PE208	EX208G2	COE	CCE	29,60	18,20	2,0	
-	65,0	R1/8"	67,8	95,0	PE209	UK209G2H	CO	CC	31,85	20,80	2,3	
57,2	-	R1/8"	67,8	95,0	PE209	UC209G2	CO	CC	31,85	20,80	2,2	45
57,2	-	R1/8"	67,8	95,0	PE209	US209G2	CO	CC	31,85	20,80	2,1	
-	63,5	R1/8"	82,0	95,0	PE209	ES209G2	COE	CCE	31,85	20,80	2,2	
-	63,5	R1/8"	82,0	95,0	PE209	EX209G2	COE	CCE	31,85	20,80	2,4	
-	70,0	R1/8"	74,6	100,0	PE210	UK210G2H	CO	CC	35,10	23,20	2,9	
61,8	-	R1/8"	74,6	100,0	PE210	UC210G2	CO	CC	35,10	23,20	2,7	50
61,8	-	R1/8"	74,6	100,0	PE210	US210G2	CO	CC	35,10	23,20	2,7	
-	69,9	R1/8"	90,0	100,0	PE210	ES210G2	COE	CCE	35,10	23,20	2,7	
-	69,9	R1/8"	90,0	100,0	PE210	EX210G2	COE	CCE	35,10	23,20	2,9	
-	75,0	R1/8"	75,2	110,0	PE211	UK211G2H	CO	CC	43,55	29,20	3,5	
69,0	-	R1/8"	75,2	110,0	PE211	UC211G2	CO	CC	43,55	29,20	3,4	55
69,0	-	R1/8"	75,2	110,0	PE211	US211G2	CO	CC	43,55	29,20	3,4	
-	76,2	R1/8"	102,0	110,0	PE211	ES211G2	COE	CCE	43,55	29,20	3,2	
-	76,2	R1/8"	102,0	110,0	PE211	EX211G2	COE	CCE	43,55	29,20	3,7	
74,9	-	R1/8"	87,8	120,0	PE212	UC212G2	CO	CC	52,50	32,80	4,8	60
74,9	-	R1/8"	87,8	120,0	PE212	US212G2	CO	CC	52,50	32,80	4,6	
-	84,2	R1/8"	109,0	120,0	PE212	ES212G2	COE	CCE	52,50	32,80	4,5	
-	84,2	R1/8"	109,0	120,0	PE212	EX212G2	COE	CCE	52,50	32,80	5,1	
-	85,0	R1/8"	88,8	132,0	PE213	UK213G2H	CO	CC	57,20	40,00	7,3	
82,0	-	R1/8"	88,8	132,0	PE213	UC213G2	CO	CC	57,20	40,00	6,1	65
-	86,0	R1/8"	118,0	132,0	PE213	EX213G2	COE	CCE	57,20	40,00	6,6	
-	98,0	R1/8"	-	-	PE215	UK215G2H	-	-	66,00	49,50	6,8	
86,5	-	R1/8"	-	-	PE214	UC214G2	-	-	62,00	45,00	6,1	70
-	96,8	R1/8"	-	-	PE214	EX214G2	-	-	62,00	45,00	6,6	
-	105,0	R1/8"	-	-	PE216	UK216G2H	-	-	72,50	54,20	9,4	

→ Pillow block unit

PE200

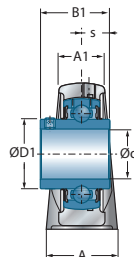
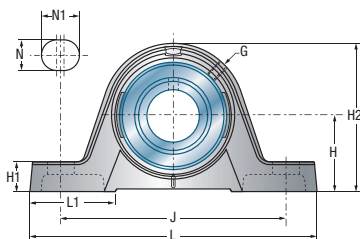
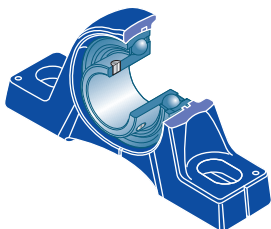

UCPE200

Shaft diameter		Unit		Main dimensions [mm]												
d mm		L	H	A1	A	J	N	N1	L1	H1	H2	s1	B	B1	s	
75	UCPE215	265	82,5	48	66	210	22	30	78,0	27,5	164,0	-	-	77,8	33,3	
	EXPE215	265	82,5	48	66	210	22	30	78,0	27,5	164,0	-	-	92,1	37,3	
80	UCPE216	290	89,0	55	78	232	26	34	90,0	30,0	175,0	-	-	82,6	33,3	
	EXPE216	290	89,0	55	78	232	26	34	90,0	30,0	175,0	-	-	95,2	37,3	
	UKPE218H	330	101,6	55	85	268	27	35	99,0	35,0	200,0	42,0	86,0	-	-	
90	UCPE218	330	101,6	55	85	268	27	35	99,0	35,0	200,0	-	-	96,0	39,7	
	EXPE218	330	101,6	55	85	268	27	35	99,0	35,0	200,0	-	-	72,5	24,5	

* = equipped with two open protective caps for passing shafts: suffix CO or COE
 ** = equipped with one open and one closed protective cap for shaft ends: suffix CC or CCE

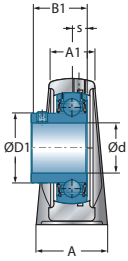

USPE200

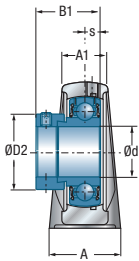

ESPE200

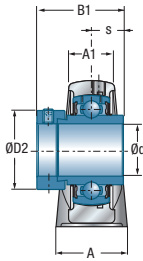

EXPE200

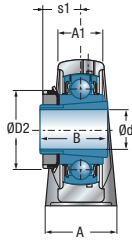

UKPE200H

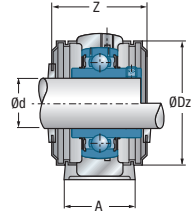

UCPE200CO(CC)

Main dimensions [mm]

Main dimensions [mm]					Housing	Bearing insert	Open protective cap*	Closed protective cap**	Dynamic load rating	Static load rating	Weight	Shaft diameter
D1	D2	G	Z	Dz					C_r [kN]	C_{0r} [kN]	kg	d mm
91,5	-	R1/8"	-	-	PE215	UC215G2	-	-	66,00	49,50	6,9	75
-	102,0	R1/8"	-	-	PE215	EX215G2	-	-	66,00	49,50	7,5	
98,0	-	R1/8"	-	-	PE216	UC216G2	-	-	72,50	54,20	9,0	80
-	110,0	R1/8"	-	-	PE216	EX216G2	-	-	72,50	54,20	9,3	
-	120,0	R1/8"	-	-	PE218	UK218G2H	-	-	96,00	71,50	13,6	
111,0	-	R1/8"	-	-	PE218	UC218G2	-	-	96,00	71,50	13,3	90
-	120,0	R1/8"	-	-	PE218	EX218G2	-	-	96,00	71,50	13,8	



→ Pillow block unit

PLE200

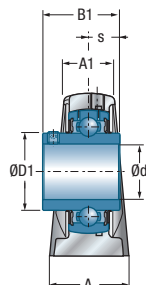
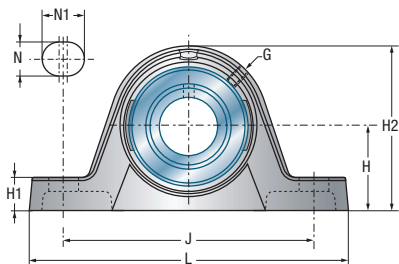
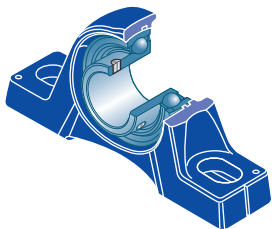

UCPLE200

Shaft diameter		Unit		Main dimensions [mm]										
d mm		L	H	A1	A	J	N	N1	H1	H2	s1	B	B1	s
12	UCPLE201	126,5	31,8	22,5	32,0	94,5	11	17,0	12,5	63,7	-	-	31,0	12,7
	USPLE201	119,0	27,0	20,5	30,0	88,5	11	14,0	11,0	54,0	-	-	22,0	6,0
	ESPLE201	119,0	27,0	20,5	30,0	88,5	11	14,0	11,0	54,0	-	-	28,6	6,5
	EXPLE201	126,5	31,8	22,5	32,0	94,5	11	17,0	12,5	63,7	-	-	43,5	17,0
15	UCPLE202	126,5	31,8	22,5	32,0	94,5	11	17,0	12,5	63,7	-	-	31,0	12,7
	USPLE202	119,0	27,0	20,5	30,0	88,5	11	14,0	11,0	54,0	-	-	22,0	6,0
	ESPLE202	119,0	27,0	20,5	30,0	88,5	11	14,0	11,0	54,0	-	-	28,6	6,5
	EXPLE202	126,5	31,8	22,5	32,0	94,5	11	17,0	12,5	63,7	-	-	43,5	17,0
17	UCPLE203	126,5	31,8	22,5	32,0	94,5	11	17,0	12,5	63,7	-	-	31,0	12,7
	USPLE203	119,0	27,0	20,5	30,0	88,5	11	14,0	11,0	54,0	-	-	22,0	6,0
	ESPLE203	119,0	27,0	20,5	30,0	88,5	11	14,0	11,0	54,0	-	-	28,6	6,5
	EXPLE203	126,5	31,8	22,5	32,0	94,5	11	17,0	12,5	63,7	-	-	43,5	17,0
20	UCPLE204	126,5	31,8	22,5	32,0	94,5	11	17,0	12,5	63,7	-	-	31,0	12,7
	USPLE204	126,5	31,8	22,5	32,0	94,5	11	17,0	12,5	63,7	-	-	25,0	7,0
	ESPLE204	126,5	31,8	22,5	32,0	94,5	11	17,0	12,5	63,7	-	-	30,9	7,5
	EXPLE204	126,5	31,8	22,5	32,0	94,5	11	17,0	12,5	63,7	-	-	43,5	17,0
	UKPLE205H	139,0	33,3	24,5	36,5	104,2	11	17,0	12,8	67,8	18,5	35,0	-	-
25	UCPLE205	139,0	33,3	24,5	36,5	104,2	11	17,0	12,8	67,8	-	-	34,0	14,3
	USPLE205	139,0	33,3	24,5	36,5	104,2	11	17,0	12,8	67,8	-	-	27,0	7,5
	ESPLE205	139,0	33,3	24,5	36,5	104,2	11	17,0	12,8	67,8	-	-	30,9	7,5
	EXPLE205	139,0	33,3	24,5	36,5	104,2	11	17,0	12,8	67,8	-	-	44,3	17,4
	UKPLE206H	161,5	39,7	27,5	41,5	119,0	14	24,5	14,5	79,5	20,5	38,0	-	-
30	UCPLE206	161,5	39,7	27,5	41,5	119,0	14	24,5	14,5	79,5	-	-	38,1	15,9
	USPLE206	161,5	39,7	27,5	41,5	119,0	14	24,5	14,5	79,5	-	-	30,0	8,0
	ESPLE206	161,5	39,7	27,5	41,5	119,0	14	24,5	14,5	79,5	-	-	35,7	9,0
	EXPLE206	161,5	39,7	27,5	41,5	119,0	14	24,5	14,5	79,5	-	-	48,3	18,2
	UKPLE207H	166,0	46,2	30,5	44,5	129,0	14	21,5	16,0	91,5	22,5	43,0	-	-
35	UCPLE207	166,0	46,2	30,5	44,5	129,0	14	21,5	16,0	91,5	-	-	42,9	17,5
	USPLE207	166,0	46,2	30,5	44,5	129,0	14	21,5	16,0	91,5	-	-	32,0	8,5
	ESPLE207	166,0	46,2	30,5	44,5	129,0	14	21,5	16,0	91,5	-	-	38,9	9,5
	EXPLE207	166,0	46,2	30,5	44,5	129,0	14	21,5	16,0	91,5	-	-	51,1	18,8
	UKPLE208H	180,5	49,2	34,5	51,0	137,5	14	24,5	18,5	98,5	24,5	46,0	-	-

* = equipped with two open protective caps for passing shafts; suffix CO or COE
 ** = equipped with one open and one closed protective cap for shaft ends; suffix CC or CCE

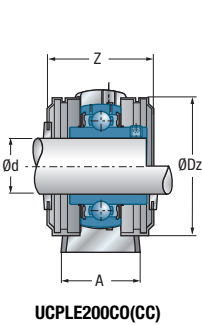
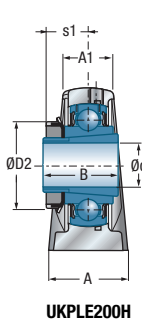
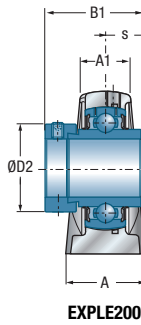
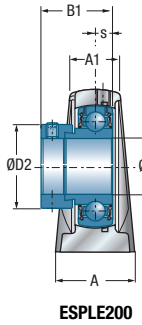
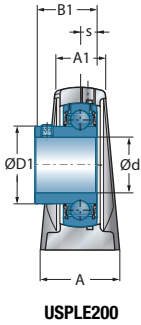

USPLE200

ESPLE200

EXPLE200

UKPLE200H

UCPL200CO(C)

Main dimensions [mm]

					Housing	Bearing insert	Open protective cap*	Closed protective cap**	Dynamic load rating	Static load rating	Weight	Shaft diameter
D1	D2	G	Z	Dz					C _r [kN]	C _{0r} [kN]	kg	d mm
29,0	-	M6x1	44,6	54,0	PLE204	UC201G2	CO	CC	12,80	6,65	0,5	12
24,6	-	M6x1	40,6	46,0	PLE203	US201G2	CO	CC	9,55	4,78	0,4	
-	28,6	M6x1	54,0	46,0	PLE203	ES201G2	COE	CCE	9,55	4,78	0,5	
-	33,3	M6x1	63,0	54,0	PLE204	EX201G2	COE	CCE	12,80	6,65	0,6	
29,0	-	M6x1	44,6	54,0	PLE204	UC202G2	CO	CC	12,80	6,65	0,5	15
24,6	-	M6x1	40,6	46,0	PLE203	US202G2	CO	CC	9,55	4,78	0,4	
-	28,6	M6x1	54,0	46,0	PLE203	ES202G2	COE	CCE	9,55	4,78	0,5	
-	33,3	M6x1	63,0	54,0	PLE204	EX202G2	COE	CCE	12,80	6,65	0,6	
29,0	-	M6x1	44,6	54,0	PLE204	UC203G2	CO	CC	12,80	6,65	0,5	17
24,6	-	M6x1	40,6	46,0	PLE203	US203G2	CO	CC	9,55	4,78	0,4	
-	28,6	M6x1	54,0	46,0	PLE203	ES203G2	COE	CCE	9,55	4,78	0,5	
-	33,3	M6x1	63,0	54,0	PLE204	EX203G2	COE	CCE	12,80	6,65	0,6	
29,0	-	M6x1	44,6	54,0	PLE204	UC204G2	CO	CC	12,80	6,65	0,5	20
29,0	-	M6x1	44,6	54,0	PLE204	US204G2	CO	CC	12,80	6,65	0,5	
-	33,3	M6x1	63,0	54,0	PLE204	ES204G2	COE	CCE	12,80	6,65	0,5	
-	33,3	M6x1	63,0	54,0	PLE204	EX204G2	COE	CCE	12,80	6,65	0,6	
-	38,0	M6x1	47,8	60,0	PLE205	UK205G2H	CO	CC	14,00	7,88	0,8	
34,0	-	M6x1	47,8	60,0	PLE205	UC205G2	CO	CC	14,00	7,88	0,7	25
34,0	-	M6x1	47,8	60,0	PLE205	US205G2	CO	CC	14,00	7,88	0,7	
-	38,1	M6x1	65,0	60,0	PLE205	ES205G2	COE	CCE	14,00	7,88	0,7	
-	38,1	M6x1	65,0	60,0	PLE205	EX205G2	COE	CCE	14,00	7,88	0,8	
-	45,0	M6x1	52,8	70,0	PLE206	UK206G2H	CO	CC	19,50	11,20	1,2	
40,3	-	M6x1	52,8	70,0	PLE206	UC206G2	CO	CC	19,50	11,20	1,1	30
40,3	-	M6x1	52,8	70,0	PLE206	US206G2	CO	CC	19,50	11,20	1,1	
-	44,5	M6x1	71,0	70,0	PLE206	ES206G2	COE	CCE	19,50	11,20	1,1	
-	44,5	M6x1	71,0	70,0	PLE206	EX206G2	COE	CCE	19,50	11,20	1,2	
-	52,0	M6x1	57,4	80,0	PLE207	UK207G2H	CO	CC	25,70	15,20	1,6	
48,0	-	M6x1	57,4	80,0	PLE207	UC207G2	CO	CC	25,70	15,20	1,5	
48,0	-	M6x1	57,4	80,0	PLE207	US207G2	CO	CC	25,70	15,20	1,5	
-	55,6	M6x1	76,0	80,0	PLE207	ES207G2	COE	CCE	25,70	15,20	1,6	
-	55,6	M6x1	76,0	80,0	PLE207	EX207G2	COE	CCE	25,70	15,20	1,7	
-	58,0	M6x1	66,8	88,0	PLE208	UK208G2H	CO	CC	29,60	18,20	1,9	



→ Pillow block unit

PLE200

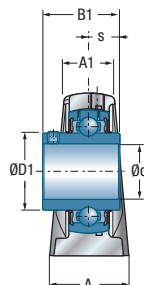
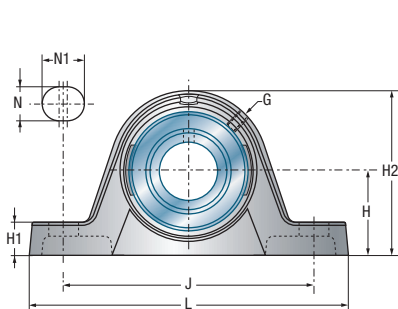
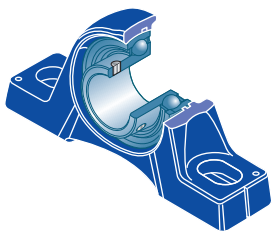

Shaft diameter		Unit		Main dimensions [mm]										
d mm		L	H	A1	A	J	N	N1	H1	H2	s1	B	B1	s
40	UCPLE208	180,5	49,2	34,5	51,0	137,5	14	24,5	18,5	98,5	-	-	49,2	19,0
	USPLE208	180,5	49,2	34,5	51,0	137,5	14	24,5	18,5	98,5	-	-	34,0	9,0
	ESPLE208	180,5	49,2	34,5	51,0	137,5	14	24,5	18,5	98,5	-	-	43,7	11,0
	EXPLE208	180,5	49,2	34,5	51,0	137,5	14	24,5	18,5	98,5	-	-	56,3	21,4
	UKPLE209H	197,5	52,4	35,0	54,0	151,5	14	24,0	18,4	106,4	26,0	50,0	-	-
45	UCPLE209	197,5	52,4	35,0	54,0	151,5	14	24,0	18,4	106,4	-	-	49,2	19,0
	USPLE209	197,5	52,4	35,0	54,0	151,5	14	24,0	18,4	106,4	-	-	41,2	10,2
	ESPLE209	197,5	52,4	35,0	54,0	151,5	14	24,0	18,4	106,4	-	-	43,7	11,0
	EXPLE209	197,5	52,4	35,0	54,0	151,5	14	24,0	18,4	106,4	-	-	56,3	21,4
	UKPLE210H	214,0	55,6	36,0	55,0	164,0	14	27,0	19,3	114,0	27,5	55,0	-	-
50	UCPLE210	214,0	55,6	36,0	55,0	164,0	14	27,0	19,3	114,0	-	-	51,6	19,0
	USPLE210	214,0	55,6	36,0	55,0	164,0	14	27,0	19,3	114,0	-	-	43,5	10,9
	ESPLE210	214,0	55,6	36,0	55,0	164,0	14	27,0	19,3	114,0	-	-	43,7	11,0
	EXPLE210	214,0	55,6	36,0	55,0	164,0	14	27,0	19,3	114,0	-	-	62,7	24,6
	UKPLE211H	219,5	61,3	39,5	60,0	170,5	18	26,0	23,2	128,0	29,0	59,0	-	-
55	UCPLE211	219,5	61,3	39,5	60,0	170,5	18	26,0	23,2	128,0	-	-	55,6	22,2
	USPLE211	219,5	61,3	39,5	60,0	170,5	18	26,0	23,2	128,0	-	-	45,3	11,8
	ESPLE211	219,5	61,3	39,5	60,0	170,5	18	26,0	23,2	128,0	-	-	48,4	12,0
	EXPLE211	219,5	61,3	39,5	60,0	170,5	18	26,0	23,2	128,0	-	-	71,3	27,7
	UKPLE212H	245,0	68,3	50,8	79,4	193,7	18	29,1	28,6	138,1	31,0	62,0	-	-
60	UCPLE212	245,0	68,3	50,8	79,4	193,7	18	29,1	28,6	138,1	-	-	65,1	25,4
	USPLE212	245,0	68,3	50,8	79,4	193,7	18	29,1	28,6	138,1	-	-	53,7	14,9
	ESPLE212	245,0	68,3	50,8	79,4	193,7	18	29,1	28,6	138,1	-	-	49,3	12,0
	EXPLE212	245,0	68,3	50,8	79,4	193,7	18	29,1	28,6	138,1	-	-	77,7	30,9

* = equipped with two open protective caps for passing shafts; suffix CO or COE
 ** = equipped with one open and one closed protective cap for shaft ends; suffix CC or CCE

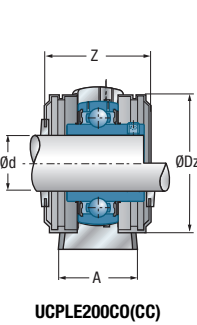
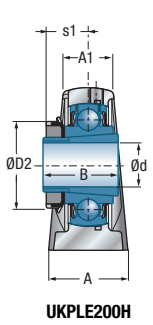
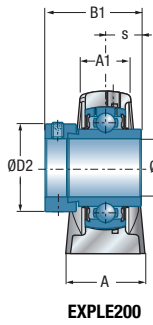
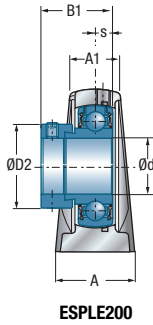
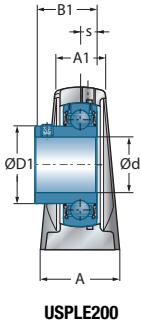

USPLE200

ESPLE200

EXPLE200

UKPLE200H

UCPL200CO(C)

Main dimensions [mm]

Main dimensions [mm]					Housing	Bearing insert	Open protective cap*	Closed protective cap**	Dynamic load rating	Static load rating	Weight	Shaft diameter
D1	D2	G	Z	Dz					C_r [kN]	C_{Or} [kN]	kg	d mm
53,0	-	M6x1	66,8	88,0	PLE208	UC208G2	CO	CC	29,60	18,20	1,8	40
53,0	-	M6x1	66,8	88,0	PLE208	US208G2	CO	CC	29,60	18,20	1,8	
-	60,3	M6x1	79,0	88,0	PLE208	ES208G2	COE	CCE	29,60	18,20	1,8	
-	60,3	M6x1	79,0	88,0	PLE208	EX208G2	COE	CCE	29,60	18,20	2,0	
-	65,0	M6x1	67,8	95,0	PLE209	UK209G2H	CO	CC	31,85	20,80	2,3	
57,2	-	M6x1	67,8	95,0	PLE209	UC209G2	CO	CC	31,85	20,80	2,2	45
57,2	-	M6x1	67,8	95,0	PLE209	US209G2	CO	CC	31,85	20,80	2,1	
-	63,5	M6x1	82,0	95,0	PLE209	ES209G2	COE	CCE	31,85	20,80	2,2	
-	63,5	M6x1	82,0	95,0	PLE209	EX209G2	COE	CCE	31,85	20,80	2,4	
-	70,0	M6x1	74,6	100,0	PLE210	UK210G2H	CO	CC	35,10	23,20	2,9	
61,8	-	M6x1	74,6	100,0	PLE210	UC210G2	CO	CC	35,10	23,20	2,7	50
61,8	-	M6x1	74,6	100,0	PLE210	US210G2	CO	CC	35,10	23,20	2,7	
-	69,9	M6x1	90,0	100,0	PLE210	ES210G2	COE	CCE	35,10	23,20	2,7	
-	69,9	M6x1	90,0	100,0	PLE210	EX210G2	COE	CCE	35,10	23,20	2,9	
-	75,0	M6x1	75,2	110,0	PLE211	UK211G2H	CO	CC	43,55	29,20	3,5	
69,0	-	M6x1	75,2	110,0	PLE211	UC211G2	CO	CC	43,55	29,20	3,4	55
69,0	-	M6x1	75,2	110,0	PLE211	US211G2	CO	CC	43,55	29,20	3,4	
-	76,2	M6x1	102,0	110,0	PLE211	ES211G2	COE	CCE	43,55	29,20	3,2	
-	76,2	M6x1	102,0	110,0	PLE211	EX211G2	COE	CCE	43,55	29,20	3,7	
-	80,0	M6x1	87,8	120,0	PLE212	UK212G2H	CO	CC	52,50	32,80	4,8	
74,9	-	M6x1	87,8	120,0	PLE212	UC212G2	CO	CC	52,50	32,80	4,8	60
74,9	-	M6x1	87,8	120,0	PLE212	US212G2	CO	CC	52,50	32,80	4,6	
-	84,2	M6x1	109,0	120,0	PLE212	ES212G2	COE	CCE	52,50	32,80	4,5	
-	84,2	M6x1	109,0	120,0	PLE212	EX212G2	COE	CCE	52,50	32,80	5,1	



→ Pillow block unit

P200
P300

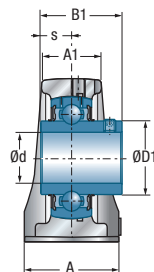
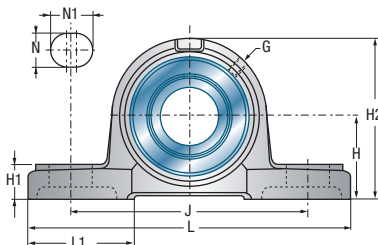
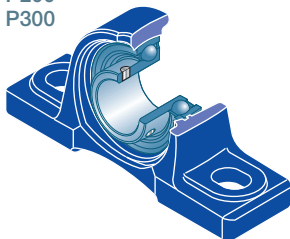

UCP200
UCP300

Shaft diameter		Unit		Main dimensions [mm]												
d mm		L	H	A1	A	J	N	N1	L1	H1	H2	s1	B	B1	s	
12	UCP201	127	33,3	22	38	95	13	19	42	15	65	-	-	31,0	12,7	
	USP201	127	30,2	22	38	95	13	19	42	15	62	-	-	22,0	6,0	
	ESP201	127	30,2	22	38	95	13	19	42	15	62	-	-	28,6	6,5	
	EXP201	127	33,3	22	38	95	13	19	42	15	65	-	-	43,5	17,0	
15	UCP202	127	33,3	22	38	95	13	19	42	15	65	-	-	31,0	12,7	
	USP202	127	30,2	22	38	95	13	19	42	15	62	-	-	22,0	6,0	
	ESP202	127	30,2	22	38	95	13	19	42	15	62	-	-	28,6	6,5	
	EXP202	127	33,3	22	38	95	13	19	42	15	65	-	-	43,5	17,0	
17	UCP203	127	33,3	22	38	95	13	19	42	15	65	-	-	31,0	12,7	
	USP203	127	30,2	22	38	95	13	19	42	15	62	-	-	22,0	6,0	
	ESP203	127	30,2	22	38	95	13	19	42	15	62	-	-	28,6	6,5	
	EXP203	127	33,3	22	38	95	13	19	42	15	65	-	-	43,5	17,0	
20	UCP204	127	33,3	22	38	95	13	19	42	15	65	-	-	31,0	12,7	
	USP204	127	33,3	22	38	95	13	19	42	15	65	-	-	25,0	7,0	
	ESP204	127	33,3	22	38	95	13	19	42	15	65	-	-	30,9	7,5	
	EXP204	127	33,3	22	38	95	13	19	42	15	65	-	-	43,5	17,0	
	UKP205H	140	36,5	26	38	105	13	19	42	16	70	18,5	35,0	-	-	
	UKP305H	175	45,0	32	45	132	17	20	54	15	85	21,5	35,0	-	-	
25	UCP205	140	36,5	26	38	105	13	19	42	16	70	-	-	34,0	14,3	
	USP205	140	36,5	26	38	105	13	19	42	16	70	-	-	27,0	7,5	
	ESP205	140	36,5	26	38	105	13	19	42	16	70	-	-	30,9	7,5	
	EXP205	140	36,5	26	38	105	13	19	42	16	70	-	-	44,3	17,4	
	UKP206H	165	42,9	30	48	121	17	21	54	18	83	20,5	38,0	-	-	
	UCP305	175	45,0	32	45	132	17	20	54	15	85	-	-	38,0	15,0	
	EXP305	175	45,0	32	45	132	17	20	54	15	85	-	-	46,8	16,7	
	UKP306H	180	50,0	36	50	140	17	20	54	18	95	23,0	38,0	-	-	
30	UCP206	165	42,9	30	48	121	17	21	54	18	83	-	-	38,1	15,9	
	USP206	165	42,9	30	48	121	17	21	54	18	83	-	-	30,0	8,0	
	ESP206	165	42,9	30	48	121	17	21	54	18	83	-	-	35,7	9,0	
	EXP206	165	42,9	30	48	121	17	21	54	18	83	-	-	48,3	18,2	
	UKP207H	167	47,6	31	48	127	17	21	54	19	94	22,5	43,0	-	-	
	UCP306	180	50,0	36	50	140	17	20	54	18	95	-	-	43,0	17,0	
	EXP306	180	50,0	36	50	140	17	20	54	18	95	-	-	50,0	17,5	
	UKP307H	210	56,0	38	56	160	17	25	60	20	106	25,5	43,0	-	-	

* = equipped with two open protective caps for passing shafts; suffix CO or COE
 ** = equipped with one open and one closed protective cap for shaft ends; suffix CC or CCE

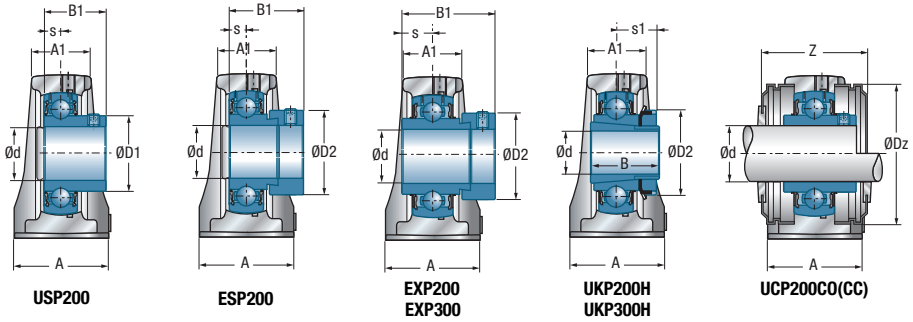

Main dimensions [mm]

					Housing	Bearing insert	Open protective cap*	Closed protective cap**	Dynamic load rating	Static load rating	Weight	Shaft diameter
D1	D2	G	Z	Dz					C_r [kN]	C_{Or} [kN]	kg	d mm
29,0	-	M6x1	45,0	54,0	P204	UC201G2	CO	CC	12,80	6,65	0,7	12
24,6	-	M6x1	45,0	46,0	P203	US201G2	CO	CC	9,55	4,78	0,7	
-	28,6	M6x1	58,4	46,0	P203	ES201G2	COE	CCE	9,55	4,78	0,7	
-	33,3	M6x1	63,4	54,0	P204	EX201G2	COE	CCE	12,80	6,65	0,8	
29,0	-	M6x1	45,0	54,0	P204	UC202G2	CO	CC	12,80	6,65	0,7	16
24,6	-	M6x1	45,0	46,0	P203	US202G2	CO	CC	9,55	4,78	0,6	
-	28,6	M6x1	58,4	46,0	P203	ES202G2	COE	CCE	9,55	4,78	0,7	
-	33,3	M6x1	63,4	54,0	P204	EX202G2	COE	CCE	12,80	6,65	0,8	
29,0	-	M6x1	45,0	54,0	P204	UC203G2	CO	CC	12,80	6,65	0,7	17
24,6	-	M6x1	45,0	46,0	P203	US203G2	CO	CC	9,55	4,78	0,6	
-	28,6	M6x1	58,4	46,0	P203	ES203G2	COE	CCE	9,55	4,78	0,7	
-	33,3	M6x1	63,4	54,0	P204	EX203G2	COE	CCE	12,80	6,65	0,8	
29,0	-	M6x1	45,0	54,0	P204	UC204G2	CO	CC	12,80	6,65	0,7	20
29,0	-	M6x1	45,0	54,0	P204	US204G2	CO	CC	12,80	6,65	0,7	
-	33,3	M6x1	63,4	54,0	P204	ES204G2	COE	CCE	12,80	6,65	0,7	
-	33,3	M6x1	63,4	54,0	P204	EX204G2	COE	CCE	12,80	6,65	0,8	
-	38,0	M6x1	48,0	60,0	P205	UK205G2H	CO	CC	14,00	7,88	0,8	
-	38,0	M6x1	-	-	P305	UK305G2H	-	-	22,36	11,50	1,6	
34,0	-	M6x1	48,0	60,0	P205	UC205G2	CO	CC	14,00	7,88	0,8	25
34,0	-	M6x1	48,0	60,0	P205	US205G2	CO	CC	14,00	7,88	0,8	
-	38,1	M6x1	65,2	60,0	P205	ES205G2	COE	CCE	14,00	7,88	0,8	
-	38,1	M6x1	65,2	60,0	P205	EX205G2	COE	CCE	14,00	7,88	0,9	
-	45,0	M6x1	53,0	70,0	P206	UK206G2H	CO	CC	19,50	11,20	1,4	
35,4	-	M6x1	-	-	P305	UC305G2	-	-	22,36	11,50	1,4	
-	42,8	M6x1	-	-	P305	EX305G2	-	-	22,36	11,50	1,5	
-	45,0	M6x1	-	-	P306	UK306G2H	-	-	27,00	15,20	2,0	
40,3	-	M6x1	53,0	70,0	P206	UC206G2	CO	CC	19,50	11,20	1,4	30
40,3	-	M6x1	53,0	70,0	P206	US206G2	CO	CC	19,50	11,20	1,3	
-	44,5	M6x1	71,2	70,0	P206	ES206G2	COE	CCE	19,50	11,20	1,4	
-	44,5	M6x1	71,2	70,0	P206	EX206G2	COE	CCE	19,50	11,20	1,5	
-	52,0	M6x1	60,0	80,0	P207	UK207G2H	CO	CC	25,70	15,20	1,8	
44,6	-	M6x1	-	-	P306	UC306G2	-	-	27,00	15,20	1,9	
-	50,0	M6x1	-	-	P306	EX306G2	-	-	27,00	15,20	2,1	
-	52,0	M6x1	-	-	P307	UK307G2H	-	-	33,50	19,20	2,8	

→ Pillow block unit

P200
P300

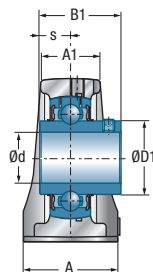
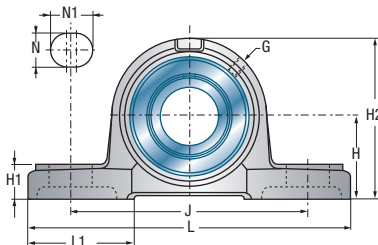
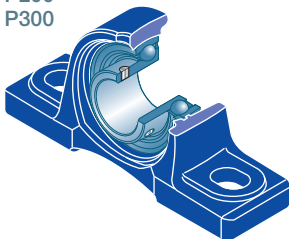

UCP200
UCP300

Shaft diameter		Unit		Main dimensions [mm]												
d mm		L	H	A1	A	J	N	N1	L1	H1	H2	s1	B	B1	s	
35	UCP207	167	47,6	31	48	127	17	21	54	19	94	-	-	42,9	17,5	
	USP207	167	47,6	31	48	127	17	21	54	19	94	-	-	32,0	8,5	
	ESP207	167	47,6	31	48	127	17	21	54	19	94	-	-	38,9	9,5	
	EXP207	167	47,6	31	48	127	17	21	54	19	94	-	-	51,1	18,8	
	UKP208H	184	49,2	34	54	137	17	23	52	19	100	24,5	46,0	-	-	
	UCP307	210	56,0	38	56	160	17	25	60	20	106	-	-	48,0	19,0	
	EXP307	210	56,0	38	56	160	17	25	60	20	106	-	-	51,6	18,3	
	UKP308H	220	60,0	42	60	170	17	27	60	22	116	27,5	46,0	-	-	
40	UCP208	184	49,2	34	54	137	17	23	52	19	100	-	-	49,2	19,0	
	USP208	184	49,2	34	54	137	17	23	52	19	100	-	-	34,0	9,0	
	ESP208	184	49,2	34	54	137	17	23	52	19	100	-	-	43,7	11,0	
	EXP208	184	49,2	34	54	137	17	23	52	19	100	-	-	56,3	21,4	
	UKP209H	190	54,0	37	54	146	17	23	60	20	108	26,0	50,0	-	-	
	UCP308	220	60,0	42	60	170	17	27	60	22	116	-	-	52,0	19,0	
	EXP308	220	60,0	42	60	170	17	27	60	22	116	-	-	57,1	19,8	
	UKP309H	245	67,0	45	67	190	20	30	65	24	129	30,0	50,0	-	-	
45	UCP209	190	54,0	37	54	146	17	23	60	20	108	-	-	49,2	19,0	
	USP209	190	54,0	37	54	146	17	23	60	20	108	-	-	41,2	10,2	
	ESP209	190	54,0	37	54	146	17	23	60	20	108	-	-	43,7	11,0	
	EXP209	190	54,0	37	54	146	17	23	60	20	108	-	-	56,3	21,4	
	UKP210H	206	57,2	39	60	159	20	25	65	22	114	27,5	55,0	-	-	
	UCP309	245	67,0	45	67	190	20	30	65	24	129	-	-	57,0	22,0	
	EXP309	245	67,0	45	67	190	20	30	65	24	129	-	-	58,7	19,8	
	UKP310H	275	75,0	48	75	212	20	35	75	27	143	32,0	55,0	-	-	
50	UCP210	206	57,2	39	60	159	20	25	65	22	114	-	-	51,6	19,0	
	USP210	206	57,2	39	60	159	20	25	65	22	114	-	-	43,5	10,9	
	ESP210	206	57,2	39	60	159	20	25	65	22	114	-	-	43,7	11,0	
	EXP210	206	57,2	39	60	159	20	25	65	22	114	-	-	62,7	24,6	
	UKP211H	219	63,5	40	60	171	20	25	70	22	126	29,0	59,0	-	-	
	UCP310	275	75,0	48	75	212	20	35	75	27	143	-	-	61,0	22,0	
	EXP310	275	75,0	48	75	212	20	35	75	27	143	-	-	66,6	24,6	
	UKP311H	310	80,0	51	80	236	20	38	85	30	154	34,0	59,0	-	-	
55	UCP211	219	63,5	40	60	171	20	25	70	22	126	-	-	55,6	22,2	
	USP211	219	63,5	40	60	171	20	25	70	22	126	-	-	45,3	11,8	

* = equipped with two open protective caps for passing shafts; suffix CO or COE
 ** = equipped with one open and one closed protective cap for shaft ends; suffix CC or CCE

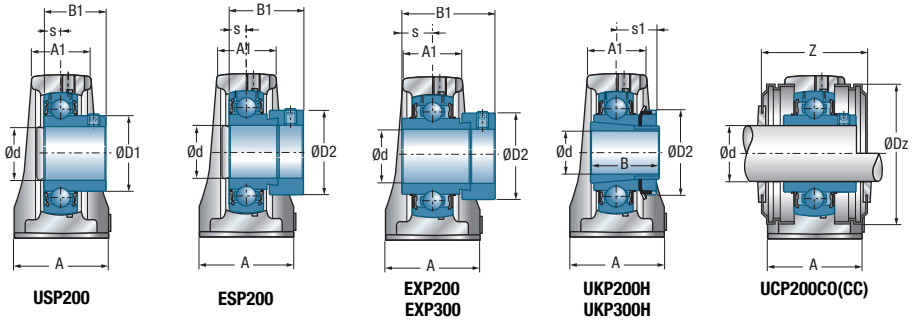

Main dimensions [mm]

Main dimensions [mm]					Housing	Bearing insert	Open protective cap*	Closed protective cap**	Dynamic load rating	Static load rating	Weight	Shaft diameter
D1	D2	G	Z	Dz					C _r [kN]	C _{0r} [kN]	kg	d mm
48,0	-	M6x1	60,0	80,0	P207	UC207G2	CO	CC	25,70	15,20	1,8	35
48,0	-	M6x1	60,0	80,0	P207	US207G2	CO	CC	25,70	15,20	1,7	
-	55,6	M6x1	78,6	80,0	P207	ES207G2	COE	CCE	25,70	15,20	1,8	
-	55,6	M6x1	78,6	80,0	P207	EX207G2	COE	CCE	25,70	15,20	1,9	
-	58,0	M6x1	69,0	88,0	P208	UK208G2H	CO	CC	29,60	18,20	2,2	
48,9	-	M6x1	-	-	P307	UC307G2	-	-	33,50	19,20	2,6	
-	55,0	M6x1	-	-	P307	EX307G2	-	-	33,50	19,20	2,7	
-	58,0	M6x1	-	-	P308	UK308G2H	-	-	40,56	24,00	3,4	
53,0	-	M6x1	69,0	88,0	P208	UC208G2	CO	CC	29,60	18,20	2,1	40
53,0	-	M6x1	69,0	88,0	P208	US208G2	CO	CC	29,60	18,20	2,1	
-	60,3	M6x1	81,2	88,0	P208	ES208G2	COE	CCE	29,60	18,20	2,1	
-	60,3	M6x1	81,2	88,0	P208	EX208G2	COE	CCE	29,60	18,20	2,3	
-	65,0	M6x1	69,0	95,0	P209	UK209G2H	CO	CC	31,85	20,80	2,5	
56,5	-	M6x1	-	-	P308	UC308G2	-	-	40,56	24,00	3,3	
-	63,5	M6x1	-	-	P308	EX308G2	-	-	40,56	24,00	3,5	
-	65,0	M6x1	-	-	P309	UK309G2H	-	-	53,00	31,80	4,8	
57,2	-	M6x1	69,0	95,0	P209	UC209G2	CO	CC	31,85	20,80	2,4	45
57,2	-	M6x1	69,0	95,0	P209	US209G2	CO	CC	31,85	20,80	2,4	
-	63,5	M6x1	83,2	95,0	P209	ES209G2	COE	CCE	31,85	20,80	2,4	
-	63,5	M6x1	83,2	95,0	P209	EX209G2	COE	CCE	31,85	20,80	2,6	
-	70,0	M6x1	76,0	100,0	P210	UK210G2H	CO	CC	35,10	23,20	3,1	
61,8	-	M6x1	-	-	P309	UC309G2	-	-	53,00	31,80	4,6	
-	70,0	M6x1	-	-	P309	EX309G2	-	-	53,00	31,80	4,7	
-	70,0	M6x1	-	-	P310	UK310G2H	-	-	62,00	37,80	6,2	
61,8	-	M6x1	76,0	100,0	P210	UC210G2	CO	CC	35,10	23,20	3,0	50
61,8	-	M6x1	76,0	100,0	P210	US210G2	CO	CC	35,10	23,20	2,9	
-	69,9	M6x1	91,4	100,0	P210	ES210G2	COE	CCE	35,10	23,20	3,0	
-	69,9	M6x1	91,4	100,0	P210	EX210G2	COE	CCE	35,10	23,20	3,2	
-	75,0	M6x1	77,0	110,0	P211	UK211G2H	CO	CC	43,55	29,20	3,7	
68,7	-	M6x1	-	-	P310	UC310G2	-	-	62,00	37,80	6,1	
-	76,2	M6x1	-	-	P310	EX310G2	-	-	62,00	37,80	6,3	
-	75,0	M6x1	-	-	P311	UK311G2H	-	-	71,50	44,80	7,9	
69,0	-	M6x1	77,0	110,0	P211	UC211G2	CO	CC	43,55	29,20	3,7	55
69,0	-	M6x1	77,0	110,0	P211	US211G2	CO	CC	43,55	29,20	3,6	



→ Pillow block unit

P200
P300

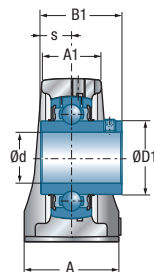
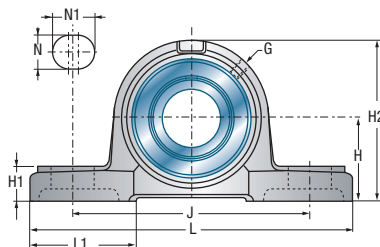
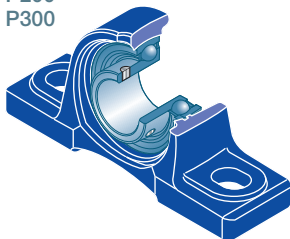

UCP200
UCP300

Shaft diameter		Unit		Main dimensions [mm]												
d mm		L	H	A1	A	J	N	N1	L1	H1	H2	s1	B	B1	s	
55	ESP211	219	63,5	40	60	171	20	25	70	22	126	-	-	48,4	12,0	
	EXP211	219	63,5	40	60	171	20	25	70	22	126	-	-	71,3	27,7	
	UKP212H	241	69,8	44	70	184	20	25	70	25	138	31,0	62,0	-	-	
	UCP311	310	80,0	51	80	236	20	38	85	30	154	-	-	66,0	25,0	
	EXP311	310	80,0	51	80	236	20	38	85	30	154	-	-	73,0	27,8	
	UKP312H	330	85,0	54	85	250	25	38	95	32	165	36,5	62,0	-	-	
60	UCP212	241	69,8	44	70	184	20	25	70	25	138	-	-	65,1	25,4	
	USP212	241	69,8	44	70	184	20	25	70	25	138	-	-	53,7	14,9	
	ESP212	241	69,8	44	70	184	20	25	70	25	138	-	-	49,3	12,0	
	EXP212	241	69,8	44	70	184	20	25	70	25	138	-	-	77,7	30,9	
	UKP213H	265	76,2	46	70	203	25	29	77	27	150	32,0	65,0	-	-	
	UCP312	330	85,0	54	85	250	25	38	95	32	165	-	-	71,0	26,0	
	EXP312	330	85,0	54	85	250	25	38	95	32	165	-	-	79,4	31,0	
	UKP313H	340	90,0	57	90	260	25	38	105	33	176	38,5	65,0	-	-	
65	UCP213	265	76,2	46	70	203	25	29	77	27	150	-	-	65,1	25,4	
	EXP213	265	76,2	46	70	203	25	29	77	27	150	-	-	85,7	34,1	
	UKP215H	275	82,6	48	74	217	25	31	85	28	163	35,5	73,0	-	-	
	UCP313	340	90,0	57	90	260	25	38	105	33	176	-	-	75,0	30,0	
	EXP313	340	90,0	57	90	260	25	38	105	33	176	-	-	85,7	32,5	
	UKP315H	380	100,0	63	100	290	27	40	110	35	198	42,5	73,0	-	-	
70	UCP214	266	79,4	48	72	210	25	31	83	27	156	-	-	74,6	30,2	
	EXP214	266	79,4	48	72	210	25	31	83	27	156	-	-	85,7	34,1	
	UKP216H	292	88,9	51	78	232	25	31	91	30	175	39,0	78,0	-	-	
	UCP314	360	95,0	60	90	280	27	40	105	35	187	-	-	78,0	33,0	
	EXP314	360	95,0	60	90	280	27	40	105	35	187	-	-	92,1	34,2	
	UKP316H	400	106,0	66	110	300	27	40	110	40	210	44,5	78,0	-	-	
75	UCP215	275	82,6	48	74	217	25	31	85	28	163	-	-	77,8	33,3	
	EXP215	275	82,6	48	74	217	25	31	85	28	163	-	-	92,1	37,3	
	UKP217H	310	95,2	53	83	247	25	31	96	32	187	40,0	82,0	-	-	
	UCP315	380	100,0	63	100	290	27	40	110	35	198	-	-	82,0	32,0	
	EXP315	380	100,0	63	100	290	27	40	110	35	198	-	-	100,0	37,3	
	UKP317H	420	112,0	69	110	320	33	45	120	40	220	48,0	82,0	-	-	
80	UCP216	292	88,9	51	78	232	25	31	91	30	175	-	-	82,6	33,3	
	EXP216	292	88,9	51	78	232	25	31	91	30	175	-	-	95,2	37,3	

* = equipped with two open protective caps for passing shafts; suffix CO or COE
 ** = equipped with one open and one closed protective cap for shaft ends; suffix CC or CCE

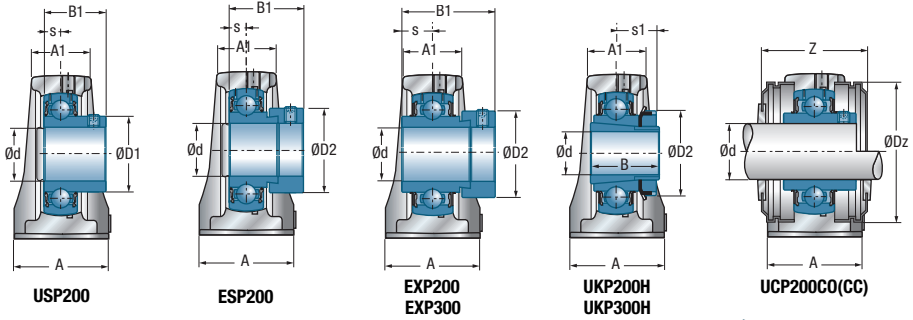

Main dimensions [mm]

Main dimensions [mm]					Housing	Bearing insert	Open protective cap*	Closed protective cap**	Dynamic load rating	Static load rating	Weight	Shaft diameter
D1	D2	G	Z	Dz					C _r [kN]	C _{0r} [kN]	kg	d mm
-	76,2	M6x1	103,8	110,0	P211	ES211G2	COE	CCE	43,55	29,20	3,4	55
-	76,2	M6x1	103,8	110,0	P211	EX211G2	COE	CCE	43,55	29,20	3,9	
-	80,0	M6x1	89,0	120,0	P212	UK212G2H	CO	CC	52,50	32,80	5,0	
74,9	-	M6x1	-	-	P311	UC311G2	-	-	71,50	44,80	7,6	
-	83,0	M6x1	-	-	P311	EX311G2	-	-	71,50	44,80	8,0	
-	80,0	M6x1	-	-	P312	UK312G2H	-	-	81,60	51,80	9,5	
74,9	-	M6x1	89,0	120,0	P212	UC212G2	CO	CC	52,50	32,80	5,0	60
74,9	-	M6x1	89,0	120,0	P212	US212G2	CO	CC	52,50	32,80	4,8	
-	84,2	M6x1	110,2	120,0	P212	ES212G2	COE	CCE	52,50	32,80	4,7	
-	84,2	M6x1	110,2	120,0	P212	EX212G2	COE	CCE	52,50	32,80	5,4	
-	85,0	M6x1	89,0	132,0	P213	UK213G2H	CO	CC	57,20	40,00	6,1	
81,0	-	M6x1	-	-	P312	UC312G2	-	-	81,60	51,80	9,5	
-	89,0	M6x1	-	-	P312	EX312G2	-	-	81,60	51,80	9,8	
-	85,0	M6x1	-	-	P313	UK313G2H	-	-	93,86	60,50	11,2	
82,0	-	M6x1	89,0	132,0	P213	UC213G2	CO	CC	57,20	40,00	6,1	65
-	86,0	M6x1	118,2	132,0	P213	EX213G2	COE	CCE	57,20	40,00	6,6	
-	98,0	M10x1	-	-	P215	UK215G2H	-	-	66,00	49,50	6,9	
87,5	-	M6x1	-	-	P313	UC313G2	-	-	93,86	60,50	11,2	
-	97,0	M6x1	-	-	P313	EX313G2	-	-	93,86	60,50	11,6	
-	98,0	M10x1	-	-	P315	UK315G2H	-	-	113,36	76,80	15,9	
86,5	-	M10x1	-	-	P214	UC214G2	-	-	62,00	45,00	6,6	70
-	96,8	M10x1	-	-	P214	EX214G2	-	-	62,00	45,00	7,1	
-	105,0	M10x1	-	-	P216	UK216G2H	-	-	72,50	54,20	9,4	
94,0	-	M10x1	-	-	P314	UC314G2	-	-	104,26	68,00	13,1	
-	102,0	M10x1	-	-	P314	EX314G2	-	-	104,26	68,00	13,6	
-	105,0	M10x1	-	-	P316	UK316G2H	-	-	122,85	86,50	19,2	
91,5	-	M10x1	-	-	P215	UC215G2	-	-	66,00	49,50	7,3	75
-	102,0	M10x1	-	-	P215	EX215G2	-	-	66,00	49,50	8,0	
-	110,0	M10x1	-	-	P217	UK217G2H	-	-	83,20	63,80	11,3	
100,5	-	M10x1	-	-	P315	UC315G2	-	-	113,36	76,80	15,2	
-	113,0	M10x1	-	-	P315	EX315G2	-	-	113,36	76,80	16,2	
-	110,0	M10x1	-	-	P317	UK317G2H	-	-	132,60	96,50	21,4	
98,0	-	M10x1	-	-	P216	UC216G2	-	-	72,50	54,20	8,9	80
-	110,0	M10x1	-	-	P216	EX216G2	-	-	72,50	54,20	9,3	



→ Pillow block unit

P200
P300

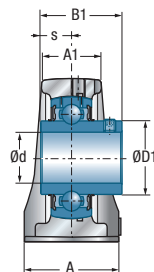
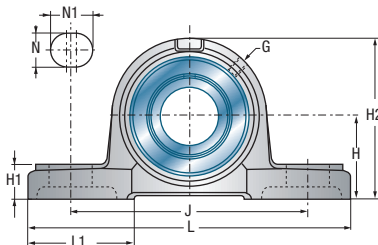
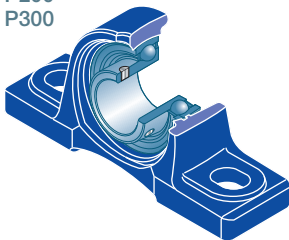

UCP200
UCP300

Shaft diameter		Unit		Main dimensions [mm]													
d mm		L	H	A1	A	J	N	N1	L1	H1	H2	s1	B	B1	s		
80	UKP218H	327	101,6	55	88	262	27	33	100	34	200	42,0	86,0	-	-		
	UCP316	400	106,0	66	110	300	27	40	110	40	210	-	-	86,0	34,0		
	EXP316	400	106,0	66	110	300	27	40	110	40	210	-	-	106,4	40,5		
	UKP318H	430	118,0	72	110	330	33	45	120	45	235	48,0	86,0	-	-		
85	UCP217	310	95,2	53	83	247	25	31	96	32	187	-	-	85,7	34,1		
	EXP217	310	95,2	53	83	247	25	31	96	32	187	-	-	73,2	23,4		
	UCP317	420	112,0	69	110	320	33	45	120	40	220	-	-	96,0	40,0		
	EXP317	420	112,0	69	110	320	33	45	120	40	220	-	-	109,5	42,0		
	UKP319H	470	125,0	75	120	360	36	50	125	45	250	52,0	90,0	-	-		
90	UCP218	327	101,6	55	88	262	27	33	100	34	200	-	-	96,0	39,7		
	EXP218	327	101,6	55	88	262	27	33	100	34	200	-	-	72,5	24,5		
	UCP318	430	118,0	72	110	330	33	45	120	45	235	-	-	96,0	40,0		
	EXP318	430	118,0	72	110	330	33	45	120	45	235	-	-	115,9	43,6		
	UKP320H	490	140,0	81	120	380	36	50	130	50	275	54,0	97,0	-	-		
95	UCP319	470	125,0	75	120	360	36	50	125	45	250	-	-	103,0	41,0		
	EXP319	470	125,0	75	120	360	36	50	125	45	250	-	-	122,3	46,8		
100	UCP320	490	140,0	81	120	380	36	50	130	50	275	-	-	108,0	42,0		
	EXP320	490	140,0	81	120	380	36	50	130	50	275	-	-	128,6	50,0		
	UKP322H	520	150,0	83	140	400	40	55	135	55	300	61,0	105,0	-	-		
105	UCP321	490	140,0	80	120	380	36	50	130	50	280	-	-	112,0	44,0		
110	UCP322	520	150,0	83	140	400	40	55	135	55	300	-	-	117,0	46,0		
	UKP324H	570	160,0	88	140	450	40	55	140	65	320	65,0	112,0	-	-		
115	UKP326H	600	180,0	94	140	480	40	55	140	75	355	69,0	121,0	-	-		
120	UCP324	570	160,0	88	140	450	40	55	140	65	320	-	-	126,0	51,0		
125	UKP328H	620	200,0	92	140	500	40	55	140	75	390	73,0	131,0	-	-		
130	UCP326	600	180,0	94	140	480	40	55	140	75	355	-	-	135,0	54,0		
140	UCP328	620	200,0	92	140	500	40	55	140	75	390	-	-	145,0	59,0		

* = equipped with two open protective caps for passing shafts; suffix CO or COE
 ** = equipped with one open and one closed protective cap for shaft ends; suffix CC or CCE

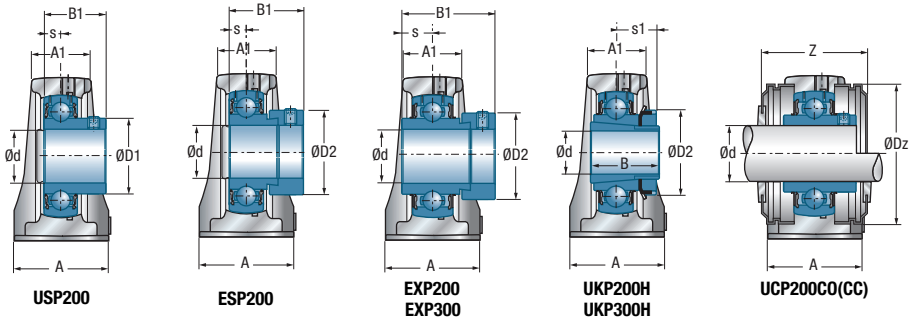

Main dimensions [mm]

					Housing	Bearing insert	Open protective cap*	Closed protective cap**	Dynamic load rating	Static load rating	Weight	Shaft diameter
D1	D2	G	Z	Dz					C_r [kN]	C_{Or} [kN]	kg	d mm
-	120,0	M10x1	-	-	P218	UK218G2H	-	-	96,00	71,50	13,7	80
107,9	-	M10x1	-	-	P316	UC316G2	-	-	122,85	86,50	19,0	
-	119,0	M10x1	-	-	P316	EX316G2	-	-	122,85	86,50	20,1	
-	120,0	M10x1	-	-	P318	UK318G2H	-	-	143,00	108,00	25,2	
105,1	-	M10x1	-	-	P217	UC217G2	-	-	83,20	63,80	10,8	85
-	119,0	M10x1	-	-	P217	EX217G2	-	-	83,20	63,80	11,2	
114,0	-	M10x1	-	-	P317	UC317G2	-	-	132,60	96,50	21,4	
-	127,0	M10x1	-	-	P317	EX317G2	-	-	132,60	96,50	22,5	
-	125,0	M10x1	-	-	P319	UK319G2H	-	-	156,00	122,00	30,8	
111,0	-	M10x1	-	-	P218	UC218G2	-	-	96,00	71,50	13,5	90
-	120,0	M10x1	-	-	P218	EX218G2	-	-	96,00	71,50	13,9	
120,0	-	M10x1	-	-	P318	UC318G2	-	-	143,00	108,00	25,1	
-	133,0	M10x1	-	-	P318	EX318G2	-	-	143,00	108,00	26,3	
-	130,0	M10x1	-	-	P320	UK320G2H	-	-	171,60	140,00	37,8	
126,5	-	M10x1	-	-	P319	UC319G2	-	-	156,00	122,00	30,5	95
-	140,0	M10x1	-	-	P319	EX319G2	-	-	156,00	122,00	32,0	
134,5	-	M10x1	-	-	P320	UC320G2	-	-	171,60	140,00	38,1	100
-	146,0	M10x1	-	-	P320	EX320G2	-	-	171,60	140,00	39,9	
-	145,0	M10x1	-	-	P322	UK322G2H	-	-	205,00	178,00	51,3	
140,5	-	M10x1	-	-	P321	UC321G2	-	-	182,00	155,00	38,5	105
149,0	-	M10x1	-	-	P322	UC322G2	-	-	205,00	178,00	47,9	110
-	155,0	M10x1	-	-	P324	UK324G2H	-	-	228,00	208,00	61,5	
-	165,0	M10x1	-	-	P326	UK326G2H	-	-	252,00	242,00	79,9	115
163,0	-	M10x1	-	-	P324	UC324G2	-	-	228,00	208,00	58,8	120
-	180,0	M10x1	-	-	P328	UK328G2H	-	-	275,00	272,00	96,3	125
177,0	-	M10x1	-	-	P326	UC326G2	-	-	252,00	242,00	75,0	130
190,0	-	M10x1	-	-	P328	UC328G2	-	-	275,00	272,00	90,4	140



Self-aligning bearing units with cast iron or pressed steel housing

→ High base pillow block unit

PH200

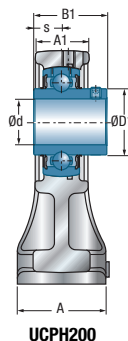
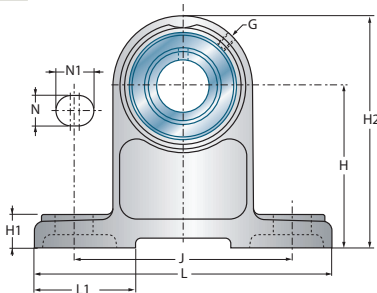
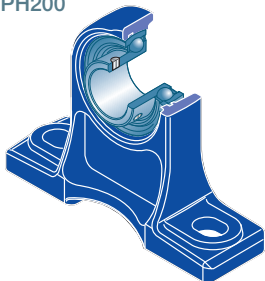

Shaft diameter		Unit		Main dimensions [mm]												
d mm		L	H	A1	A	J	N	N1	L1	H1	H2	s1	B	B1	s	
12	UCPH201	127	70	22	40	95	13	19	48	15	101	-	-	31,0	12,7	
	USPH201	127	70	19	38	95	12	16	48	13	97	-	-	22,0	6,0	
	ESPH201	127	70	19	38	95	12	16	48	13	97	-	-	28,6	6,5	
	EXPH201	127	70	22	40	95	13	19	48	15	101	-	-	43,5	17,0	
15	UCPH202	127	70	22	40	95	13	19	48	15	101	-	-	31,0	12,7	
	USPH202	127	70	19	38	95	12	16	48	13	97	-	-	22,0	6,0	
	ESPH202	127	70	19	38	95	12	16	48	13	97	-	-	28,6	6,5	
	EXPH202	127	70	22	40	95	13	19	48	15	101	-	-	43,5	17,0	
17	UCPH203	127	70	22	40	95	13	19	48	15	101	-	-	31,0	12,7	
	USPH203	127	70	19	38	95	12	16	48	13	97	-	-	22,0	6,0	
	ESPH203	127	70	19	38	95	12	16	48	13	97	-	-	28,6	6,5	
	EXPH203	127	70	22	40	95	13	19	48	15	101	-	-	43,5	17,0	
20	UCPH204	127	70	22	40	95	13	19	48	15	101	-	-	31,0	12,7	
	USPH204	127	70	22	40	95	13	19	48	15	101	-	-	25,0	7,0	
	ESPH204	127	70	22	40	95	13	19	48	15	101	-	-	30,9	7,5	
	EXPH204	127	70	22	40	95	13	19	48	15	101	-	-	43,5	17,0	
	UKPH205H	140	80	24	50	105	13	19	50	16	114	18,5	35,0	-	-	
25	UCPH205	140	80	24	50	105	13	19	50	16	114	-	-	34,0	14,3	
	USPH205	140	80	24	50	105	13	19	50	16	114	-	-	27,0	7,5	
	ESPH205	140	80	24	50	105	13	19	50	16	114	-	-	30,9	7,5	
	EXPH205	140	80	24	50	105	13	19	50	16	114	-	-	44,3	17,4	
	UKPH206H	165	90	28	50	121	17	21	56	18	130	20,5	38,0	-	-	
30	UCPH206	165	90	28	50	121	17	21	56	18	130	-	-	38,1	15,9	
	USPH206	165	90	28	50	121	17	21	56	18	130	-	-	30,0	8,0	
	ESPH206	165	90	28	50	121	17	21	56	18	130	-	-	35,7	9,0	
	EXPH206	165	90	28	50	121	17	21	56	18	130	-	-	48,3	18,2	
	UKPH207H	167	95	30	60	127	17	21	56	19	140	22,5	43,0	-	-	
35	UCPH207	167	95	30	60	127	17	21	56	19	140	-	-	42,9	17,5	
	USPH207	167	95	30	60	127	17	21	56	19	140	-	-	32,0	8,5	
	ESPH207	167	95	30	60	127	17	21	56	19	140	-	-	38,9	9,5	
	EXPH207	167	95	30	60	127	17	21	56	19	140	-	-	51,1	18,8	
	UKPH208H	184	100	34	70	137	17	25	58	19	149	24,5	46,0	-	-	

* = equipped with two open protective caps for passing shafts; suffix CO or COE
 ** = equipped with one open and one closed protective cap for shaft ends; suffix CC or CCE

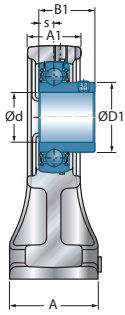

USPH200

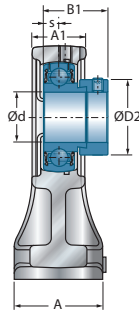

ESPH200

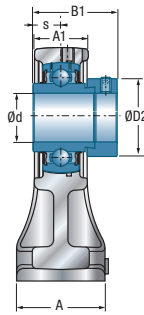

EXPH200

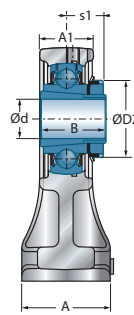

UKPH200H

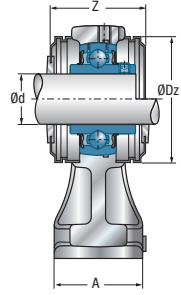

UCPH200CO(CC)

Main dimensions [mm]

Main dimensions [mm]					Housing	Bearing insert	Open protective cap*	Closed protective cap**	Dynamic load rating	Static load rating	Weight	Shaft diameter
D1	D2	G	Z	Dz					C_r [kN]	C_{Or} [kN]	kg	d mm
29,0	-	M6x1	44,6	54,0	PH204	UC201G2	CO	CC	12,80	6,65	0,9	12
24,6	-	M6x1	40,6	46,0	PH203	US201G2	CO	CC	9,55	4,78	0,7	
-	28,6	M6x1	54,0	46,0	PH203	ES201G2	COE	CCE	9,55	4,78	0,7	
-	33,3	M6x1	63,0	54,0	PH204	EX201G2	COE	CCE	12,80	6,65	1,0	
29,0	-	M6x1	44,6	54,0	PH204	UC202G2	CO	CC	12,80	6,65	0,9	15
24,6	-	M6x1	40,6	46,0	PH203	US202G2	CO	CC	9,55	4,78	0,7	
-	28,6	M6x1	54,0	46,0	PH203	ES202G2	COE	CCE	9,55	4,78	0,7	
-	33,3	M6x1	63,0	54,0	PH204	EX202G2	COE	CCE	12,80	6,65	1,0	
29,0	-	M6x1	44,6	54,0	PH204	UC203G2	CO	CC	12,80	6,65	0,8	17
24,6	-	M6x1	40,6	46,0	PH203	US203G2	CO	CC	9,55	4,78	0,7	
-	28,6	M6x1	54,0	46,0	PH203	ES203G2	COE	CCE	9,55	4,78	0,7	
-	33,3	M6x1	63,0	54,0	PH204	EX203G2	COE	CCE	12,80	6,65	1,0	
29,0	-	M6x1	44,6	54,0	PH204	UC204G2	CO	CC	12,80	6,65	0,9	20
29,0	-	M6x1	44,6	54,0	PH204	US204G2	CO	CC	12,80	6,65	0,8	
-	33,3	M6x1	63,0	54,0	PH204	ES204G2	COE	CCE	12,80	6,65	0,9	
-	33,3	M6x1	63,0	54,0	PH204	EX204G2	COE	CCE	12,80	6,65	0,9	
-	38,0	M6x1	47,8	60,0	PH205	UK205G2H	CO	CC	14,00	7,88	1,2	
34,0	-	M6x1	47,8	60,0	PH205	UC205G2	CO	CC	14,00	7,88	1,2	25
34,0	-	M6x1	47,8	60,0	PH205	US205G2	CO	CC	14,00	7,88	1,2	
-	38,1	M6x1	65,0	60,0	PH205	ES205G2	COE	CCE	14,00	7,88	1,2	
-	38,1	M6x1	65,0	60,0	PH205	EX205G2	COE	CCE	14,00	7,88	1,2	
-	45,0	M6x1	52,8	70,0	PH206	UK206G2H	CO	CC	19,50	11,20	1,8	
40,3	-	M6x1	52,8	70,0	PH206	UC206G2	CO	CC	19,50	11,20	1,7	30
40,3	-	M6x1	52,8	70,0	PH206	US206G2	CO	CC	19,50	11,20	1,7	
-	44,5	M6x1	71,0	70,0	PH206	ES206G2	COE	CCE	19,50	11,20	1,7	
-	44,5	M6x1	71,0	70,0	PH206	EX206G2	COE	CCE	19,50	11,20	1,8	
-	52,0	M6x1	57,4	80,0	PH207	UK207G2H	CO	CC	25,70	15,20	2,3	
48,0	-	M6x1	57,4	80,0	PH207	UC207G2	CO	CC	25,70	15,20	2,2	
48,0	-	M6x1	57,4	80,0	PH207	US207G2	CO	CC	25,70	15,20	2,2	
-	55,6	M6x1	76,0	80,0	PH207	ES207G2	COE	CCE	25,70	15,20	2,3	
-	55,6	M6x1	76,0	80,0	PH207	EX207G2	COE	CCE	25,70	15,20	2,4	
-	58,0	M6x1	66,8	88,0	PH208	UK208G2H	CO	CC	29,60	18,20	2,9	



→ High base pillow block unit

PH200

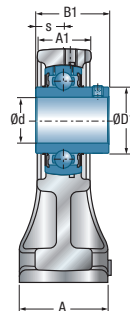
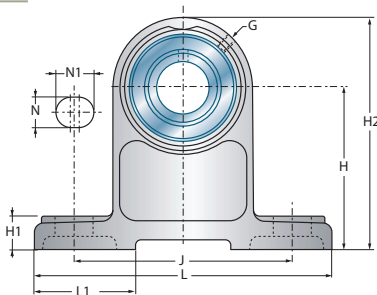
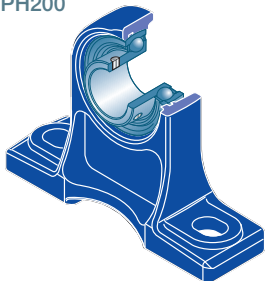

UCPH200

Shaft diameter		Unit		Main dimensions [mm]													
d mm		L	H	A1	A	J	N	N1	L1	H1	H2	s1	B	B1	s		
40	UCPH208	184	100	34	70	137	17	25	58	19	149	-	-	49,2	19,0		
	USPH208	184	100	34	70	137	17	25	58	19	149	-	-	34,0	9,0		
	ESPH208	184	100	34	70	137	17	25	58	19	149	-	-	43,7	11,0		
	EXPH208	184	100	34	70	137	17	25	58	19	149	-	-	56,3	21,4		
	UKPH209H	190	105	36	70	146	17	25	62	20	157	26,0	50,0	-	-		
45	UCPH209	190	105	36	70	146	17	25	62	20	157	-	-	49,2	19,0		
	USPH209	190	105	36	70	146	17	25	62	20	157	-	-	41,2	10,2		
	ESPH209	190	105	36	70	146	17	25	62	20	157	-	-	43,7	11,0		
	EXPH209	190	105	36	70	146	17	25	62	20	157	-	-	56,3	21,4		
	UKPH210H	206	110	36	70	159	20	25	65	22	165	27,5	55,0	-	-		
50	UCPH210	206	110	36	70	159	20	25	65	22	165	-	-	51,6	19,0		
	USPH210	206	110	36	70	159	20	25	65	22	165	-	-	43,5	10,9		
	ESPH210	206	110	36	70	159	20	25	65	22	165	-	-	43,7	11,0		
	EXPH210	206	110	36	70	159	20	25	65	22	165	-	-	62,7	24,6		

* = equipped with two open protective caps for passing shafts: suffix CO or COE
 ** = equipped with one open and one closed protective cap for shaft ends: suffix CC or CCE

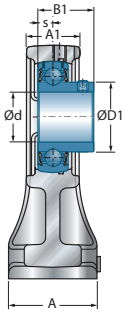

USP200

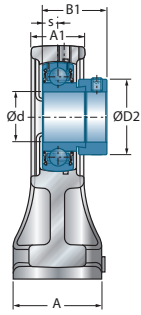

ESP200

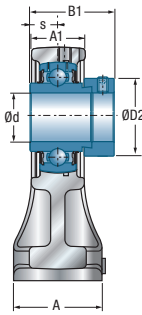

EXP200

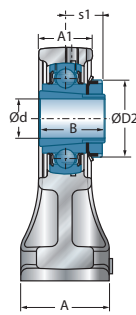

UKPH200H

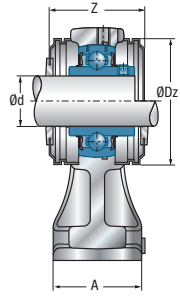

UCPH200CO(CC)

Main dimensions [mm]

Main dimensions [mm]					<i>housing</i>	<i>Bearing insert</i>	<i>Open protective cap*</i>	<i>Closed protective cap**</i>	<i>Dynamic load rating</i>	<i>Static load rating</i>	<i>Weight</i>	<i>Shaft diameter</i>
D1	D2	G	Z	Dz					C_r [kN]	C_{Or} [kN]	kg	d mm
53,0	-	M6x1	66,8	88,0	PH208	UC208G2	CO	CC	29,60	18,20	2,8	40
53,0	-	M6x1	66,8	88,0	PH208	US208G2	CO	CC	29,60	18,20	2,8	
-	60,3	M6x1	79,0	88,0	PH208	ES208G2	COE	CCE	29,60	18,20	2,8	
-	60,3	M6x1	79,0	88,0	PH208	EX208G2	COE	CCE	29,60	18,20	3,0	
-	65,0	M6x1	67,8	95,0	PH209	UK209G2H	CO	CC	31,85	20,80	3,3	45
57,2	-	M6x1	67,8	95,0	PH209	UC209G2	CO	CC	31,85	20,80	3,1	
57,2	-	M6x1	67,8	95,0	PH209	US209G2	CO	CC	31,85	20,80	3,1	
-	63,5	M6x1	82,0	95,0	PH209	ES209G2	COE	CCE	31,85	20,80	3,1	
-	63,5	M6x1	82,0	95,0	PH209	EX209G2	COE	CCE	31,85	20,80	3,3	50
-	70,0	M6x1	74,6	100,0	PH210	UK210G2H	CO	CC	35,10	23,20	3,8	
61,8	-	M6x1	74,6	100,0	PH210	UC210G2	CO	CC	35,10	23,20	3,6	
61,8	-	M6x1	74,6	100,0	PH210	US210G2	CO	CC	35,10	23,20	3,6	
-	69,9	M6x1	90,0	100,0	PH210	ES210G2	COE	CCE	35,10	23,20	3,6	50
-	69,9	M6x1	90,0	100,0	PH210	EX210G2	COE	CCE	35,10	23,20	3,8	



→ Tapped base pillow block unit

PAE200

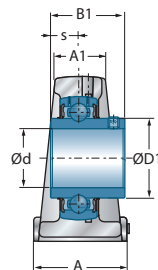
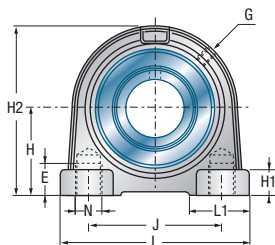
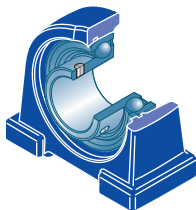

UCPAE200

Shaft diameter		Unit		Main dimensions [mm]												
d mm		L	L1	H	H1	A1	A	J	N	E	H2	s1	B	B1	s	
12	UCPAE201	65	18,0	33,3	9	19	32	50,8	M8	10,0	64	-	-	31,0	12,7	
	USPAE201	63	17,5	30,2	9	18	30	47,0	M8	10,0	57	-	-	22,0	6,0	
	ESPAE201	63	17,5	30,2	9	18	30	47,0	M8	10,0	57	-	-	28,6	6,5	
	EXPAE201	65	18,0	33,3	9	19	32	50,8	M8	10,0	64	-	-	43,5	17,0	
15	UCPAE202	65	18,0	33,3	9	19	32	50,8	M8	10,0	64	-	-	31,0	12,7	
	USPAE202	63	17,5	30,2	9	18	30	47,0	M8	10,0	57	-	-	22,0	6,0	
	ESPAE202	63	17,5	30,2	9	18	30	47,0	M8	10,0	57	-	-	28,6	6,5	
	EXPAE202	65	18,0	33,3	9	19	32	50,8	M8	10,0	64	-	-	43,5	17,0	
17	UCPAE203	65	18,0	33,3	9	19	32	50,8	M8	10,0	64	-	-	31,0	12,7	
	USPAE203	63	17,5	30,2	9	18	30	47,0	M8	10,0	57	-	-	22,0	6,0	
	ESPAE203	63	17,5	30,2	9	18	30	47,0	M8	10,0	57	-	-	28,6	6,5	
	EXPAE203	65	18,0	33,3	9	19	32	50,8	M8	10,0	64	-	-	43,5	17,0	
20	UCPAE204	65	18,0	33,3	9	19	32	50,8	M8	10,0	64	-	-	31,0	12,7	
	USPAE204	65	18,0	33,3	9	19	32	50,8	M8	10,0	64	-	-	25,0	7,0	
	ESPAE204	65	18,0	33,3	9	19	32	50,8	M8	10,0	64	-	-	30,9	7,5	
	EXPAE204	65	18,0	33,3	9	19	32	50,8	M8	10,0	64	-	-	43,5	17,0	
	UKPAE205H	70	21,0	36,5	10	21	36	50,8	M10	12,5	70	18,5	35,0	-	-	
25	UCPAE205	70	21,0	36,5	10	21	36	50,8	M10	12,5	70	-	-	34,0	14,3	
	USPAE205	70	21,0	36,5	10	21	36	50,8	M10	12,5	70	-	-	27,0	7,5	
	ESPAE205	70	21,0	36,5	10	21	36	50,8	M10	12,5	70	-	-	30,9	7,5	
	EXPAE205	70	21,0	36,5	10	21	36	50,8	M10	12,5	70	-	-	44,3	17,4	
	UKPAE206H	98	22,0	42,9	11	25	38	76,2	M10	12,5	82	20,5	38,0	-	-	
30	UCPAE206	98	22,0	42,9	11	25	38	76,2	M10	12,5	82	-	-	38,1	15,9	
	USPAE206	98	22,0	42,9	11	25	38	76,2	M10	12,5	82	-	-	30,0	8,0	
	ESPAE206	98	22,0	42,9	11	25	38	76,2	M10	12,5	82	-	-	35,7	9,0	
	EXPAE206	98	22,0	42,9	11	25	38	76,2	M10	12,5	82	-	-	48,3	18,2	
	UKPAE207H	103	22,5	47,6	12	27	45	82,6	M10	12,5	93	22,5	43,0	-	-	
35	UCPAE207	103	22,5	47,6	12	27	45	82,6	M10	12,5	93	-	-	42,9	17,5	
	USPAE207	103	22,5	47,6	12	27	45	82,6	M10	12,5	93	-	-	32,0	8,5	
	ESPAE207	103	22,5	47,6	12	27	45	82,6	M10	12,5	93	-	-	38,9	9,5	
	EXPAE207	103	22,5	47,6	12	27	45	82,6	M10	12,5	93	-	-	51,1	18,8	
	UKPAE208H	116	27,0	49,2	13	30	47	88,9	M12	15,0	99	24,5	46,0	-	-	

* = equipped with two open protective caps for passing shafts; suffix CO or COE
 ** = equipped with one open and one closed protective cap for shaft ends; suffix CC or CCE

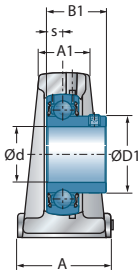

USPAE200

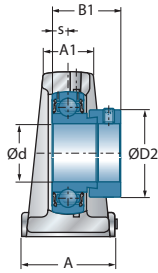

ESPAE200

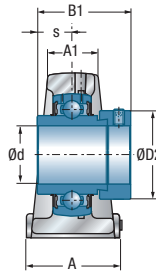

EXPAE200

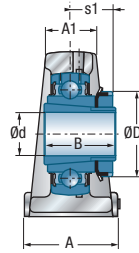

UKPAE200H

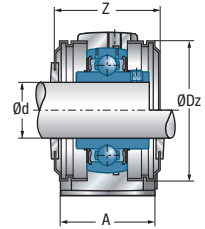

UCPAE200CO(CC)

Main dimensions [mm]

					Housing	Bearing insert	Open protective cap*	Closed protective cap**	Dynamic load rating	Static load rating	Weight	Shaft diameter
D1	D2	G	Z	Dz					C _r [kN]	C _{0r} [kN]	kg	d mm
29,0	-	R1/8"	44,6	54,0	PAE204	UC201G2	CO	CC	12,80	6,65	0,5	12
24,6	-	M6x1	40,6	46,0	PAE203	US201G2	CO	CC	9,55	4,78	0,3	
-	28,6	M6x1	54,0	46,0	PAE203	ES201G2	COE	CCE	9,55	4,78	0,4	
-	33,3	R1/8"	63,0	54,0	PAE204	EX201G2	COE	CCE	12,80	6,65	0,6	
29,0	-	R1/8"	44,6	54,0	PAE204	UC202G2	CO	CC	12,80	6,65	0,5	15
24,6	-	M6x1	40,6	46,0	PAE203	US202G2	CO	CC	9,55	4,78	0,3	
-	28,6	M6x1	54,0	46,0	PAE203	ES202G2	COE	CCE	9,55	4,78	0,4	
-	33,3	R1/8"	63,0	54,0	PAE204	EX202G2	COE	CCE	12,80	6,65	0,6	
29,0	-	R1/8"	44,6	54,0	PAE204	UC203G2	CO	CC	12,80	6,65	0,4	17
24,6	-	M6x1	40,6	46,0	PAE203	US203G2	CO	CC	9,55	4,78	0,4	
-	28,6	M6x1	54,0	46,0	PAE203	ES203G2	COE	CCE	9,55	4,78	0,4	
-	33,3	R1/8"	63,0	54,0	PAE204	EX203G2	COE	CCE	12,80	6,65	0,5	
29,0	-	R1/8"	44,6	54,0	PAE204	UC204G2	CO	CC	12,80	6,65	0,5	20
29,0	-	R1/8"	44,6	54,0	PAE204	US204G2	CO	CC	12,80	6,65	0,4	
-	33,3	R1/8"	63,0	54,0	PAE204	ES204G2	COE	CCE	12,80	6,65	0,4	
-	33,3	R1/8"	63,0	54,0	PAE204	EX204G2	COE	CCE	12,80	6,65	0,5	
-	38,0	R1/8"	47,8	60,0	PAE205	UK205G2H	CO	CC	14,00	7,88	0,6	
34,0	-	R1/8"	47,8	60,0	PAE205	UC205G2	CO	CC	14,00	7,88	0,6	25
34,0	-	R1/8"	47,8	60,0	PAE205	US205G2	CO	CC	14,00	7,88	0,6	
-	38,1	R1/8"	65,0	60,0	PAE205	ES205G2	COE	CCE	14,00	7,88	0,6	
-	38,1	R1/8"	65,0	60,0	PAE205	EX205G2	COE	CCE	14,00	7,88	0,6	
-	45,0	R1/8"	52,8	70,0	PAE206	UK206G2H	CO	CC	19,50	11,20	1,0	
40,3	-	R1/8"	52,8	70,0	PAE206	UC206G2	CO	CC	19,50	11,20	1,0	30
40,3	-	R1/8"	52,8	70,0	PAE206	US206G2	CO	CC	19,50	11,20	0,9	
-	44,5	R1/8"	71,0	70,0	PAE206	ES206G2	COE	CCE	19,50	11,20	1,0	
-	44,5	R1/8"	71,0	70,0	PAE206	EX206G2	COE	CCE	19,50	11,20	1,1	
-	52,0	R1/8"	57,4	80,0	PAE207	UK207G2H	CO	CC	25,70	15,20	1,4	
48,0	-	R1/8"	57,4	80,0	PAE207	UC207G2	CO	CC	25,70	15,20	1,3	
48,0	-	R1/8"	57,4	80,0	PAE207	US207G2	CO	CC	25,70	15,20	1,3	
-	55,6	R1/8"	76,0	80,0	PAE207	ES207G2	COE	CCE	25,70	15,20	1,3	
-	55,6	R1/8"	76,0	80,0	PAE207	EX207G2	COE	CCE	25,70	15,20	1,4	
-	58,0	R1/8"	66,8	88,0	PAE208	UK208G2H	CO	CC	29,60	18,20	1,7	



→ Tapped base pillow block unit

PAE200

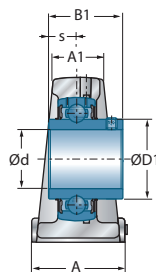
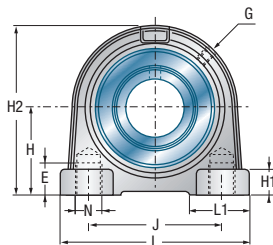
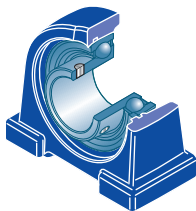

UCPAE200

Shaft diameter		Unit		Main dimensions [mm]												
d mm		L	L1	H	H1	A1	A	J	N	E	H2	s1	B	B1	s	
40	UCPAE208	116	27,0	49,2	13	30	47	88,9	M12	15,0	99	-	-	49,2	19,0	
	USPAE208	116	27,0	49,2	13	30	47	88,9	M12	15,0	99	-	-	34,0	9,0	
	ESPAE208	116	27,0	49,2	13	30	47	88,9	M12	15,0	99	-	-	43,7	11,0	
	EXPAE208	116	27,0	49,2	13	30	47	88,9	M12	15,0	99	-	-	56,3	21,4	
	UKPAE209H	120	29,0	53,9	14	32	48	95,3	M12	15,0	107	26,0	50,0	-	-	
45	UCPAE209	120	29,0	53,9	14	32	48	95,3	M12	15,0	107	-	-	49,2	19,0	
	USPAE209	120	29,0	53,9	14	32	48	95,3	M12	15,0	107	-	-	41,2	10,2	
	ESPAE209	120	29,0	53,9	14	32	48	95,3	M12	15,0	107	-	-	43,7	11,0	
	EXPAE209	120	29,0	53,9	14	32	48	95,3	M12	15,0	107	-	-	56,3	21,4	
	UKPAE210H	135	33,5	57,2	15	34	54	101,6	M16	20,0	115	27,5	55,0	-	-	
50	UCPAE210	135	33,5	57,2	15	34	54	101,6	M16	20,0	115	-	-	51,6	19,0	
	USPAE210	135	33,5	57,2	15	34	54	101,6	M16	20,0	115	-	-	43,5	10,9	
	ESPAE210	135	33,5	57,2	15	34	54	101,6	M16	20,0	115	-	-	43,7	11,0	
	EXPAE210	135	33,5	57,2	15	34	54	101,6	M16	20,0	115	-	-	62,7	24,6	
	UKPAE211H	150	32,0	64,0	16	35	60	118,0	M16	20,0	125	29,0	59,0	-	-	
55	UCPAE211	150	32,0	64,0	16	35	60	118,0	M16	20,0	125	-	-	55,6	22,2	
	USPAE211	150	32,0	64,0	16	35	60	118,0	M16	20,0	125	-	-	45,3	11,8	
	ESPAE211	150	32,0	64,0	16	35	60	118,0	M16	20,0	125	-	-	48,4	12,0	
	EXPAE211	150	32,0	64,0	16	35	60	118,0	M16	20,0	125	-	-	71,3	27,7	
	UKPAE212H	150	32,0	69,9	16	42	60	118,0	M16	20,0	140	31,0	62,0	-	-	
60	UCPAE212	150	32,0	69,9	16	42	60	118,0	M16	20,0	140	-	-	65,1	25,4	
	USPAE212	150	32,0	69,9	16	42	60	118,0	M16	20,0	140	-	-	53,7	14,9	
	ESPAE212	150	32,0	69,9	16	42	60	118,0	M16	20,0	140	-	-	49,3	12,0	
	EXPAE212	150	32,0	69,9	16	42	60	118,0	M16	20,0	140	-	-	77,7	30,9	

* = equipped with two open protective caps for passing shafts; suffix CO or COE
 ** = equipped with one open and one closed protective cap for shaft ends; suffix CC or CCE

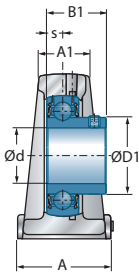

USPAE200

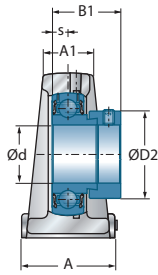

ESPAE200

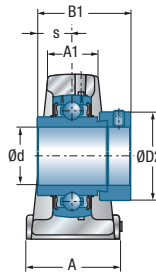

EXPAE200

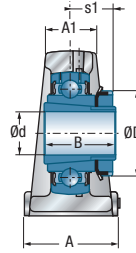

UKPAE200H

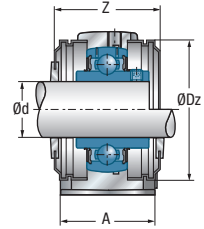

UCPAE200C(CC)

Main dimensions [mm]

					Housing	Bearing insert	Open protective cap*	Closed protective cap**	Dynamic load rating	Static load rating	Weight	Shaft diameter
D1	D2	G	Z	Dz					C _r [kN]	C _{0r} [kN]	kg	d mm
53,0	-	R1/8"	66,8	88,0	PAE208	UC208G2	CO	CC	29,60	18,20	1,6	40
53,0	-	R1/8"	66,8	88,0	PAE208	US208G2	CO	CC	29,60	18,20	1,6	
-	60,3	R1/8"	79,0	88,0	PAE208	ES208G2	COE	CCE	29,60	18,20	1,6	
-	60,3	R1/8"	79,0	88,0	PAE208	EX208G2	COE	CCE	29,60	18,20	1,8	
-	65,0	R1/8"	67,8	95,0	PAE209	UK209G2H	CO	CC	31,85	20,80	2,0	
57,2	-	R1/8"	67,8	95,0	PAE209	UC209G2	CO	CC	31,85	20,80	1,9	45
57,2	-	R1/8"	67,8	95,0	PAE209	US209G2	CO	CC	31,85	20,80	1,9	
-	63,5	R1/8"	82,0	95,0	PAE209	ES209G2	COE	CCE	31,85	20,80	1,9	
-	63,5	R1/8"	82,0	95,0	PAE209	EX209G2	COE	CCE	31,85	20,80	2,1	
-	70,0	R1/8"	74,6	100,0	PAE210	UK210G2H	CO	CC	35,10	23,20	2,6	
61,8	-	R1/8"	74,6	100,0	PAE210	UC210G2	CO	CC	35,10	23,20	2,5	50
61,8	-	R1/8"	74,6	100,0	PAE210	US210G2	CO	CC	35,10	23,20	2,4	
-	69,9	R1/8"	90,0	100,0	PAE210	ES210G2	COE	CCE	35,10	23,20	2,5	
-	69,9	R1/8"	90,0	100,0	PAE210	EX210G2	COE	CCE	35,10	23,20	2,7	
-	75,0	R1/8"	75,2	110,0	PAE211	UK211G2H	CO	CC	43,55	29,20	3,3	
69,0	-	R1/8"	75,2	110,0	PAE211	UC211G2	CO	CC	43,55	29,20	3,2	55
69,0	-	R1/8"	75,2	110,0	PAE211	US211G2	CO	CC	43,55	29,20	3,2	
-	76,2	R1/8"	102,0	110,0	PAE211	ES211G2	COE	CCE	43,55	29,20	3,0	
-	76,2	R1/8"	102,0	110,0	PAE211	EX211G2	COE	CCE	43,55	29,20	3,5	
-	80,0	R1/8"	87,8	120,0	PAE212	UK212G2H	CO	CC	52,50	32,80	4,0	
74,9	-	R1/8"	87,8	120,0	PAE212	UC212G2	CO	CC	52,50	32,80	4,0	60
74,9	-	R1/8"	87,8	120,0	PAE212	US212G2	CO	CC	52,50	32,80	3,8	
-	84,2	R1/8"	109,0	120,0	PAE212	ES212G2	COE	CCE	52,50	32,80	3,7	
-	84,2	R1/8"	109,0	120,0	PAE212	EX212G2	COE	CCE	52,50	32,80	4,4	





→ Tapped base pillow block unit

PG200

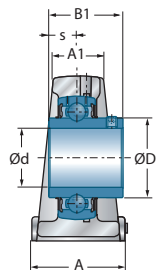
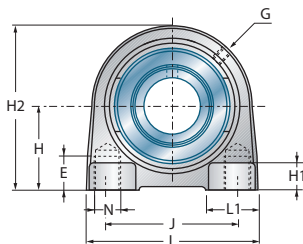
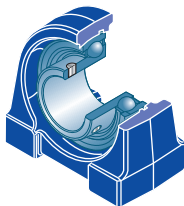

UCPG200

Shaft diameter		Unit		Main dimensions [mm]												
d mm		L	H	A1	A	J	N	E	L1	H1	H2	s1	B	B1	s	
12	UCPG201	70	33,3	20	38	49	M8	16	21	14	64	-	-	31,0	12,7	
	USPG201	55	30,2	13	30	38	M6	15	17	14	57	-	-	22,0	6,0	
	ESPG201	55	30,2	13	30	38	M6	15	17	14	57	-	-	28,6	6,5	
	EXPG201	70	33,3	20	38	49	M8	16	21	14	64	-	-	43,5	17,0	
15	UCPG202	70	33,3	20	38	49	M8	16	21	14	64	-	-	31,0	12,7	
	USPG202	55	30,2	13	30	38	M6	15	17	14	57	-	-	22,0	6,0	
	ESPG202	55	30,2	13	30	38	M6	15	17	14	57	-	-	28,6	6,5	
	EXPG202	70	33,3	20	38	49	M8	16	21	14	64	-	-	43,5	17,0	
17	UCPG203	70	33,3	20	38	49	M8	16	21	14	64	-	-	31,0	12,7	
	USPG203	55	30,2	13	30	38	M6	15	17	14	57	-	-	22,0	6,0	
	ESPG203	55	30,2	13	30	38	M6	15	17	14	57	-	-	28,6	6,5	
	EXPG203	70	33,3	20	38	49	M8	16	21	14	64	-	-	43,5	17,0	
20	UCPG204	70	33,3	20	38	49	M8	16	21	14	64	-	-	31,0	12,7	
	USPG204	70	33,3	20	38	49	M8	16	21	14	64	-	-	25,0	7,0	
	ESPG204	70	33,3	20	38	49	M8	16	21	14	64	-	-	30,9	7,5	
	EXPG204	70	33,3	20	38	49	M8	16	21	14	64	-	-	43,5	17,0	
	UKPG205H	75	36,5	25	38	50	M10	18	25	15	70	18,5	35,0	-	-	
25	UCPG205	75	36,5	25	38	50	M10	18	25	15	70	-	-	34,0	14,3	
	USPG205	75	36,5	25	38	50	M10	18	25	15	70	-	-	27,0	7,5	
	ESPG205	75	36,5	25	38	50	M10	18	25	15	70	-	-	30,9	7,5	
	EXPG205	75	36,5	25	38	50	M10	18	25	15	70	-	-	44,3	17,4	
	UKPG206H	85	42,9	25	48	60	M10	18	25	17	83	20,5	38,0	-	-	
30	UCPG206	85	42,9	25	48	60	M10	18	25	17	83	-	-	38,1	15,9	
	USPG206	85	42,9	25	48	60	M10	18	25	17	83	-	-	30,0	8,0	
	ESPG206	85	42,9	25	48	60	M10	18	25	17	83	-	-	35,7	9,0	
	EXPG206	85	42,9	25	48	60	M10	18	25	17	83	-	-	48,3	18,2	
	UKPG207H	100	47,6	27	48	68	M12	22	35	20	93	22,5	43,0	-	-	
35	UCPG207	100	47,6	27	48	68	M12	22	35	20	93	-	-	42,9	17,5	
	USPG207	100	47,6	27	48	68	M12	22	35	20	93	-	-	32,0	8,5	
	ESPG207	100	47,6	27	48	68	M12	22	35	20	93	-	-	38,9	9,5	
	EXPG207	100	47,6	27	48	68	M12	22	35	20	93	-	-	51,1	18,8	
	UKPG208H	110	49,2	30	54	78	M12	22	35	20	98	24,5	46,0	-	-	

* = equipped with two open protective caps for passing shafts; suffix CO or COE
 ** = equipped with one open and one closed protective cap for shaft ends; suffix CC or CCE

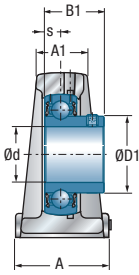

USPG200

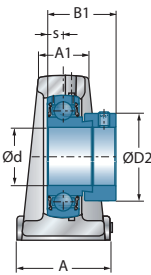

ESPG200

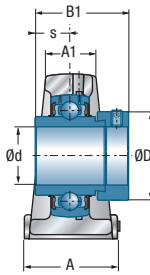

EXPG200

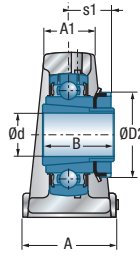

UKPG200H

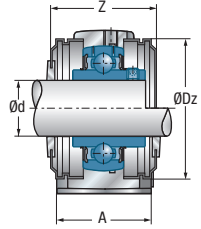

UCPG200CO(C)

Main dimensions [mm]

Main dimensions [mm]					Housing	Bearing insert	Open protective cap*	Closed protective cap**	Dynamic load rating	Static load rating	Weight	Shaft diameter
D1	D2	G	Z	Dz					C_r [kN]	C_{Or} [kN]	kg	d mm
29,0	-	M6x1	44,6	54,0	PG204	UC201G2	CO	CC	12,80	6,65	0,6	12
24,6	-	M6x1	40,6	46,0	PG203	US201G2	CO	CC	9,55	4,78	0,3	
-	28,6	M6x1	54,0	46,0	PG203	ES201G2	COE	CCE	9,55	4,78	0,4	
-	33,3	M6x1	63,0	54,0	PG204	EX201G2	COE	CCE	12,80	6,65	0,7	
29,0	-	M6x1	44,6	54,0	PG204	UC202G2	CO	CC	12,80	6,65	0,6	15
24,6	-	M6x1	40,6	46,0	PG203	US202G2	CO	CC	9,55	4,78	0,3	
-	28,6	M6x1	54,0	46,0	PG203	ES202G2	COE	CCE	9,55	4,78	0,4	
-	33,3	M6x1	63,0	54,0	PG204	EX202G2	COE	CCE	12,80	6,65	0,7	
29,0	-	M6x1	44,6	54,0	PG204	UC203G2	CO	CC	12,80	6,65	0,4	17
24,6	-	M6x1	40,6	46,0	PG203	US203G2	CO	CC	9,55	4,78	0,3	
-	28,6	M6x1	54,0	46,0	PG203	ES203G2	COE	CCE	9,55	4,78	0,4	
-	33,3	M6x1	63,0	54,0	PG204	EX203G2	COE	CCE	12,80	6,65	0,7	
29,0	-	M6x1	44,6	54,0	PG204	UC204G2	CO	CC	12,80	6,65	0,6	20
29,0	-	M6x1	44,6	54,0	PG204	US204G2	CO	CC	12,80	6,65	0,6	
-	33,3	M6x1	63,0	54,0	PG204	ES204G2	COE	CCE	12,80	6,65	0,6	
-	33,3	M6x1	63,0	54,0	PG204	EX204G2	COE	CCE	12,80	6,65	0,6	
-	38,0	M6x1	47,8	60,0	PG205	UK205G2H	CO	CC	14,00	7,88	0,7	
34,0	-	M6x1	47,8	60,0	PG205	UC205G2	CO	CC	14,00	7,88	0,7	25
34,0	-	M6x1	47,8	60,0	PG205	US205G2	CO	CC	14,00	7,88	0,7	
-	38,1	M6x1	65,0	60,0	PG205	ES205G2	COE	CCE	14,00	7,88	0,7	
-	38,1	M6x1	65,0	60,0	PG205	EX205G2	COE	CCE	14,00	7,88	0,7	
-	45,0	M6x1	52,8	70,0	PG206	UK206G2H	CO	CC	19,50	11,20	1,1	
40,3	-	M6x1	52,8	70,0	PG206	UC206G2	CO	CC	19,50	11,20	1,1	30
40,3	-	M6x1	52,8	70,0	PG206	US206G2	CO	CC	19,50	11,20	1,0	
-	44,5	M6x1	71,0	70,0	PG206	ES206G2	COE	CCE	19,50	11,20	1,1	
-	44,5	M6x1	71,0	70,0	PG206	EX206G2	COE	CCE	19,50	11,20	1,2	
-	52,0	M6x1	57,4	80,0	PG207	UK207G2H	CO	CC	25,70	15,20	1,6	
48,0	-	M6x1	57,4	80,0	PG207	UC207G2	CO	CC	25,70	15,20	1,5	35
48,0	-	M6x1	57,4	80,0	PG207	US207G2	CO	CC	25,70	15,20	1,5	
-	55,6	M6x1	76,0	80,0	PG207	ES207G2	COE	CCE	25,70	15,20	1,6	
-	55,6	M6x1	76,0	80,0	PG207	EX207G2	COE	CCE	25,70	15,20	1,7	
-	58,0	M6x1	66,8	88,0	PG208	UK208G2H	CO	CC	29,60	18,20	1,9	





→ Tapped base pillow block unit

PG200

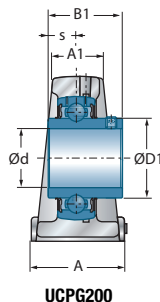
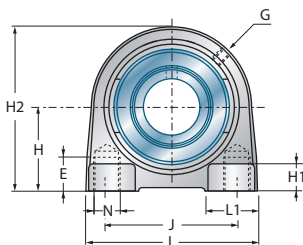
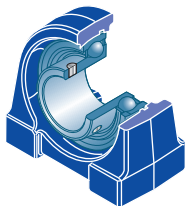

UCPG200

Shaft diameter		Unit		Main dimensions [mm]												
d mm		L	H	A1	A	J	N	E	L1	H1	H2	s1	B	B1	s	
40	UCPG208	110	49,2	30	54	78	M12	22	35	20	98	-	-	49,2	19,0	
	USPG208	110	49,2	30	54	78	M12	22	35	20	98	-	-	34,0	9,0	
	ESPG208	110	49,2	30	54	78	M12	22	35	20	98	-	-	43,7	11,0	
	EXPG208	110	49,2	30	54	78	M12	22	35	20	98	-	-	56,3	21,4	
	UKPG209H	120	53,9	33	54	85	M12	22	40	20	106	26,0	50,0	-	-	
45	UCPG209	120	53,9	33	54	85	M12	22	40	20	106	-	-	49,2	19,0	
	USPG209	120	53,9	33	54	85	M12	22	40	20	106	-	-	41,2	10,2	
	ESPG209	120	53,9	33	54	85	M12	22	40	20	106	-	-	43,7	11,0	
	EXPG209	120	53,9	33	54	85	M12	22	40	20	106	-	-	56,3	21,4	
	UKPG210H	135	57,2	35	60	95	M16	25	40	21	114	27,5	55,0	-	-	
50	UCPG210	135	57,2	35	60	95	M16	25	40	21	114	-	-	51,6	19,0	
	USPG210	135	57,2	35	60	95	M16	25	40	21	114	-	-	43,5	10,9	
	ESPG210	135	57,2	35	60	95	M16	25	40	21	114	-	-	43,7	11,0	
	EXPG210	135	57,2	35	60	95	M16	25	40	21	114	-	-	62,7	24,6	
	UKPG211H	140	63,5	34	60	100	M16	25	40	25	126	29,0	59,0	-	-	
55	UCPG211	140	63,5	34	60	100	M16	25	40	25	126	-	-	55,6	22,2	
	USPG211	140	63,5	34	60	100	M16	25	40	25	126	-	-	45,3	11,8	
	ESPG211	140	63,5	34	60	100	M16	25	40	25	126	-	-	48,4	12,0	
	EXPG211	140	63,5	34	60	100	M16	25	40	25	126	-	-	71,3	27,7	
	UKPG212H	150	69,8	40	70	105	M16	25	50	25	138	31,0	62,0	-	-	
60	UCPG212	150	69,8	40	70	105	M16	25	50	25	138	-	-	65,1	25,4	
	USPG212	150	69,8	40	70	105	M16	25	50	25	138	-	-	53,7	14,9	
	ESPG212	150	69,8	40	70	105	M16	25	50	25	138	-	-	49,3	12,0	
	EXPG212	150	69,8	40	70	105	M16	25	50	25	138	-	-	77,7	30,9	

* = equipped with two open protective caps for passing shafts; suffix CO or COE
 ** = equipped with one open and one closed protective cap for shaft ends; suffix CC or CCE

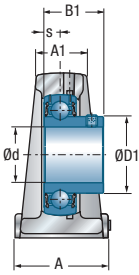

USPG200

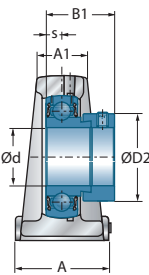

ESPG200

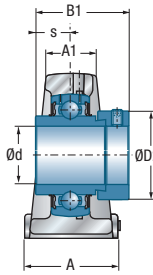

EXP200

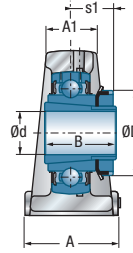

UKPG200H

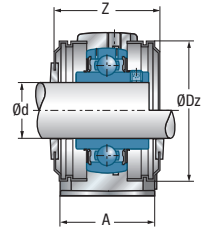

UCPG200CO(CC)

Main dimensions [mm]

					Housing	Bearing insert	Open protective cap*	Closed protective cap**	Dynamic load rating	Static load rating	Weight	Shaft diameter
D1	D2	G	Z	Dz					C_r [kN]	C_{Or} [kN]	kg	d mm
53,0	-	M6x1	66,8	88,0	PG208	UC208G2	CO	CC	29,60	18,20	1,8	40
53,0	-	M6x1	66,8	88,0	PG208	US208G2	CO	CC	29,60	18,20	1,8	
-	60,3	M6x1	79,0	88,0	PG208	ES208G2	COE	CCE	29,60	18,20	1,8	
-	60,3	M6x1	79,0	88,0	PG208	EX208G2	COE	CCE	29,60	18,20	2,0	
-	65,0	M6x1	67,8	95,0	PG209	UK209G2H	CO	CC	31,85	20,80	2,3	
57,2	-	M6x1	67,8	95,0	PG209	UC209G2	CO	CC	31,85	20,80	2,2	45
57,2	-	M6x1	67,8	95,0	PG209	US209G2	CO	CC	31,85	20,80	2,1	
-	63,5	M6x1	82,0	95,0	PG209	ES209G2	COE	CCE	31,85	20,80	2,2	
-	63,5	M6x1	82,0	95,0	PG209	EX209G2	COE	CCE	31,85	20,80	2,4	
-	70,0	M6x1	74,6	100,0	PG210	UK210G2H	CO	CC	35,10	23,20	2,9	
61,8	-	M6x1	74,6	100,0	PG210	UC210G2	CO	CC	35,10	23,20	2,8	50
61,8	-	M6x1	74,6	100,0	PG210	US210G2	CO	CC	35,10	23,20	2,8	
-	69,9	M6x1	90,0	100,0	PG210	ES210G2	COE	CCE	35,10	23,20	2,8	
-	69,9	M6x1	90,0	100,0	PG210	EX210G2	COE	CCE	35,10	23,20	3,0	
-	75,0	M6x1	75,2	110,0	PG211	UK211G2H	CO	CC	43,55	29,20	3,5	
69,0	-	M6x1	75,2	110,0	PG211	UC211G2	CO	CC	43,55	29,20	3,5	55
69,0	-	M6x1	75,2	110,0	PG211	US211G2	CO	CC	43,55	29,20	3,4	
-	76,2	M6x1	102,0	110,0	PG211	ES211G2	COE	CCE	43,55	29,20	3,2	
-	76,2	M6x1	102,0	110,0	PG211	EX211G2	COE	CCE	43,55	29,20	3,7	
-	80,0	M6x1	87,8	120,0	PG212	UK212G2H	CO	CC	52,50	32,80	4,7	
74,9	-	M6x1	87,8	120,0	PG212	UC212G2	CO	CC	52,50	32,80	4,7	60
74,9	-	M6x1	87,8	120,0	PG212	US212G2	CO	CC	52,50	32,80	4,5	
-	84,2	M6x1	109,0	120,0	PG212	ES212G2	COE	CCE	52,50	32,80	4,4	
-	84,2	M6x1	109,0	120,0	PG212	EX212G2	COE	CCE	52,50	32,80	5,0	



→ Tapped base pillow block unit

PA200

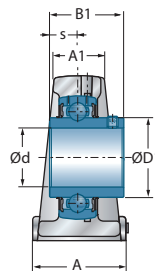
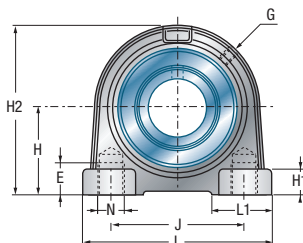
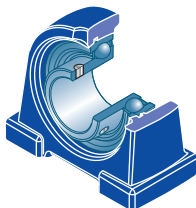

UCPA200

Shaft diameter		Unit		Main dimensions [mm]												
d mm		L	H	A1	A	J	N	E	L1	H1	H2	s1	B	B1	s	
12	UCPA201	76	30,2	22	40	52	M10	13	22	11	62	-	-	31,0	12,7	
	USPA201	70	30,2	19	36	48	M8	9	20	10	57	-	-	22,0	6,0	
	ESPA201	70	30,2	19	36	48	M8	9	20	10	57	-	-	28,6	6,5	
	EXPA201	76	30,2	22	40	52	M10	13	22	11	62	-	-	43,5	17,0	
15	UCPA202	76	30,2	22	40	52	M10	13	22	11	62	-	-	31,0	12,7	
	USPA202	70	30,2	19	36	48	M8	9	20	10	57	-	-	22,0	6,0	
	ESPA202	70	30,2	19	36	48	M8	9	20	10	57	-	-	28,6	6,5	
	EXPA202	76	30,2	22	40	52	M10	13	22	11	62	-	-	43,5	17,0	
17	UCPA203	76	30,2	22	40	52	M10	13	22	11	62	-	-	31,0	12,7	
	USPA203	70	30,2	19	36	48	M8	9	20	10	57	-	-	22,0	6,0	
	ESPA203	70	30,2	19	36	48	M8	9	20	10	57	-	-	28,6	6,5	
	EXPA203	76	30,2	22	40	52	M10	13	22	11	62	-	-	43,5	17,0	
20	UCPA204	76	30,2	22	40	52	M10	13	22	11	62	-	-	31,0	12,7	
	USPA204	76	30,2	22	40	52	M10	13	22	11	62	-	-	25,0	7,0	
	ESPA204	76	30,2	22	40	52	M10	13	22	11	62	-	-	30,9	7,5	
	EXPA204	76	30,2	22	40	52	M10	13	22	11	62	-	-	43,5	17,0	
	UKPA205H	84	36,5	23	38	56	M10	15	27	12	72	18,5	35,0	-	-	
25	UCPA205	84	36,5	23	38	56	M10	15	27	12	72	-	-	34,0	14,3	
	USPA205	84	36,5	23	38	56	M10	15	27	12	72	-	-	27,0	7,5	
	ESPA205	84	36,5	23	38	56	M10	15	27	12	72	-	-	30,9	7,5	
	EXPA205	84	36,5	23	38	56	M10	15	27	12	72	-	-	44,3	17,4	
	UKPA206H	94	42,9	25	48	66	M14	18	30	13	84	20,5	38,0	-	-	
30	UCPA206	94	42,9	25	48	66	M14	18	30	13	84	-	-	38,1	15,9	
	USPA206	94	42,9	25	48	66	M14	18	30	13	84	-	-	30,0	8,0	
	ESPA206	94	42,9	25	48	66	M14	18	30	13	84	-	-	35,7	9,0	
	EXPA206	94	42,9	25	48	66	M14	18	30	13	84	-	-	48,3	18,2	
	UKPA207H	110	47,6	27	48	80	M14	20	30	13	95	22,5	43,0	-	-	
35	UCPA207	110	47,6	27	48	80	M14	20	30	13	95	-	-	42,9	17,5	
	USPA207	110	47,6	27	48	80	M14	20	30	13	95	-	-	32,0	8,5	
	ESPA207	110	47,6	27	48	80	M14	20	30	13	95	-	-	38,9	9,5	
	EXPA207	110	47,6	27	48	80	M14	20	30	13	95	-	-	51,1	18,8	
	UKPA208H	116	49,2	28	54	84	M14	20	32	13	100	24,5	46,0	-	-	

* = equipped with two open protective caps for passing shafts; suffix CO or COE
 ** = equipped with one open and one closed protective cap for shaft ends; suffix CC or CCE

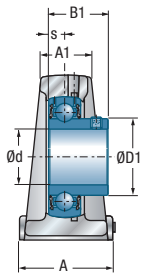

USA200

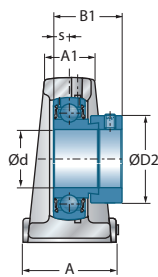

ESPA200

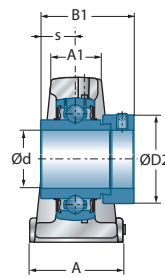

EXPA200

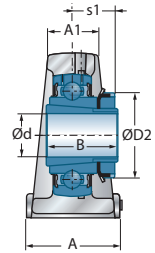

UKPA200H

Main dimensions [mm]

Main dimensions [mm]					Housing	Bearing insert	Open protective cap**	Closed protective cap**	Dynamic load rating	Static load rating	Weight	Shaft diameter
D1	D2	G	Z	Dz					C_r [kN]	C_{Or} [kN]	kg	d mm
29,0	-	M6x1	45,6	54,0	PA204	UC201G2	CO	CC	12,80	6,65	0,6	12
24,6	-	M6x1	42,6	46,0	PA203	US201G2	CO	CC	9,55	4,78	0,4	
-	28,6	M6x1	56,0	46,0	PA203	ES201G2	COE	CCE	9,55	4,78	0,4	
-	33,3	M6x1	64,0	54,0	PA204	EX201G2	COE	CCE	12,80	6,65	0,7	
29,0	-	M6x1	45,6	54,0	PA204	UC202G2	CO	CC	12,80	6,65	0,6	15
24,6	-	M6x1	42,6	46,0	PA203	US202G2	CO	CC	9,55	4,78	0,4	
-	28,6	M6x1	56,0	46,0	PA203	ES202G2	COE	CCE	9,55	4,78	0,4	
-	33,3	M6x1	64,0	54,0	PA204	EX202G2	COE	CCE	12,80	6,65	0,6	
29,0	-	M6x1	45,6	54,0	PA204	UC203G2	CO	CC	12,80	6,65	0,5	17
24,6	-	M6x1	42,6	46,0	PA203	US203G2	CO	CC	9,55	4,78	0,4	
-	28,6	M6x1	56,0	46,0	PA203	ES203G2	COE	CCE	9,55	4,78	0,4	
-	33,3	M6x1	64,0	54,0	PA204	EX203G2	COE	CCE	12,80	6,65	0,6	
29,0	-	M6x1	45,6	54,0	PA204	UC204G2	CO	CC	12,80	6,65	0,5	20
29,0	-	M6x1	45,6	54,0	PA204	US204G2	CO	CC	12,80	6,65	0,5	
-	33,3	M6x1	64,0	54,0	PA204	ES204G2	COE	CCE	12,80	6,65	0,5	
-	33,3	M6x1	64,0	54,0	PA204	EX204G2	COE	CCE	12,80	6,65	0,6	
-	38,0	M6x1	48,0	60,0	PA205	UK205G2H	CO	CC	14,00	7,88	0,8	
34,0	-	M6x1	48,0	60,0	PA205	UC205G2	CO	CC	14,00	7,88	0,7	25
34,0	-	M6x1	48,0	60,0	PA205	US205G2	CO	CC	14,00	7,88	0,7	
-	38,1	M6x1	65,2	60,0	PA205	ES205G2	COE	CCE	14,00	7,88	0,7	
-	38,1	M6x1	65,2	60,0	PA205	EX205G2	COE	CCE	14,00	7,88	0,8	
-	45,0	M6x1	51,8	70,0	PA206	UK206G2H	CO	CC	19,50	11,20	1,1	
40,3	-	M6x1	51,8	70,0	PA206	UC206G2	CO	CC	19,50	11,20	1,1	30
40,3	-	M6x1	51,8	70,0	PA206	US206G2	CO	CC	19,50	11,20	1,0	
-	44,5	M6x1	70,0	70,0	PA206	ES206G2	COE	CCE	19,50	11,20	1,1	
-	44,5	M6x1	70,0	70,0	PA206	EX206G2	COE	CCE	19,50	11,20	1,2	
-	52,0	M6x1	60,0	80,0	PA207	UK207G2H	CO	CC	25,70	15,20	1,5	
48,0	-	M6x1	60,0	80,0	PA207	UC207G2	CO	CC	25,70	15,20	1,5	35
48,0	-	M6x1	60,0	80,0	PA207	US207G2	CO	CC	25,70	15,20	1,4	
-	55,6	M6x1	78,6	80,0	PA207	ES207G2	COE	CCE	25,70	15,20	1,5	
-	55,6	M6x1	78,6	80,0	PA207	EX207G2	COE	CCE	25,70	15,20	1,6	
-	58,0	M6x1	68,4	88,0	PA208	UK208G2H	CO	CC	29,60	18,20	1,8	

→ Tapped base pillow block unit

PA200

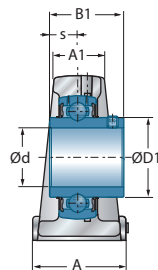
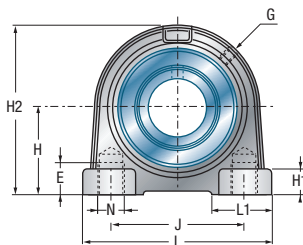
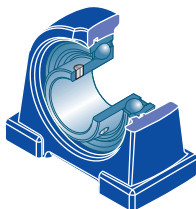

UCPA200

Shaft diameter		Unit		Main dimensions [mm]													
d mm		L	H	A1	A	J	N	E	L1	H1	H2	s1	B	B1	s		
40	UCPA208	116	49,2	28	54	84	M14	20	32	13	100	-	-	49,2	19,0		
	USPA208	116	49,2	28	54	84	M14	20	32	13	100	-	-	34,0	9,0		
	ESPA208	116	49,2	28	54	84	M14	20	32	13	100	-	-	43,7	11,0		
	EXPA208	116	49,2	28	54	84	M14	20	32	13	100	-	-	56,3	21,4		
	UKPA209H	120	54,2	32	60	90	M14	25	42	13	108	26,0	50,0	-	-		
45	UCPA209	120	54,2	32	60	90	M14	25	42	13	108	-	-	49,2	19,0		
	USPA209	120	54,2	32	60	90	M14	25	42	13	108	-	-	41,2	10,2		
	ESPA209	120	54,2	32	60	90	M14	25	42	13	108	-	-	43,7	11,0		
	EXPA209	120	54,2	32	60	90	M14	25	42	13	108	-	-	56,3	21,4		
	UKPA210H	130	57,2	32	60	94	M16	25	35	14	116	27,5	55,0	-	-		
50	UCPA210	130	57,2	32	60	94	M16	25	35	14	116	-	-	51,6	19,0		
	USPA210	130	57,2	32	60	94	M16	25	35	14	116	-	-	43,5	10,9		
	ESPA210	130	57,2	32	60	94	M16	25	35	14	116	-	-	43,7	11,0		
	EXPA210	130	57,2	32	60	94	M16	25	35	14	116	-	-	62,7	24,6		
	UKPA211H	140	63,5	33	66	104	M16	25	47	14	125	29,0	59,0	-	-		
55	UCPA211	140	63,5	33	66	104	M16	25	47	14	125	-	-	55,6	22,2		
	USPA211	140	63,5	33	66	104	M16	25	47	14	125	-	-	45,3	11,8		
	ESPA211	140	63,5	33	66	104	M16	25	47	14	125	-	-	48,4	12,0		
	EXPA211	140	63,5	33	66	104	M16	25	47	14	125	-	-	71,3	27,7		
	UKPA212H	150	69,9	36	68	114	M16	25	52	15	138	31,0	62,0	-	-		
60	UCPA212	150	69,9	36	68	114	M16	25	52	15	138	-	-	65,1	25,4		
	USPA212	150	69,9	36	68	114	M16	25	52	15	138	-	-	53,7	14,9		
	ESPA212	150	69,9	36	68	114	M16	25	52	15	138	-	-	49,3	12,0		
	EXPA212	150	69,9	36	68	114	M16	25	52	15	138	-	-	77,7	30,9		

* = equipped with two open protective caps for passing shafts; suffix CO or COE
 ** = equipped with one open and one closed protective cap for shaft ends; suffix CC or CCE

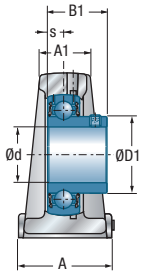

USPA200

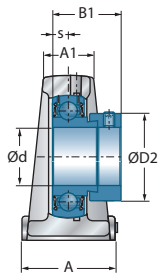

ESPA200

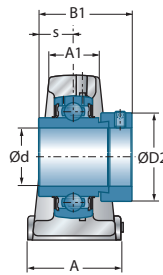

EXPA200

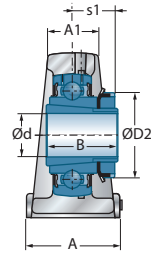

UKPA200H

Main dimensions [mm]

					Housing	Bearing insert	Open protective cap**	Closed protective cap**	Dynamic load rating	Static load rating	Weight	Shaft diameter
D1	D2	G	Z	Dz					C_r [kN]	C_{0r} [kN]	kg	d mm
53,0	-	M6x1	68,4	88,0	PA208	UC208G2	CO	CC	29,60	18,20	1,8	40
53,0	-	M6x1	68,4	88,0	PA208	US208G2	CO	CC	29,60	18,20	1,7	
-	60,3	M6x1	80,6	88,0	PA208	ES208G2	COE	CCE	29,60	18,20	1,8	
-	60,3	M6x1	80,6	88,0	PA208	EX208G2	COE	CCE	29,60	18,20	1,9	
-	65,0	M6x1	70,2	95,0	PA209	UK209G2H	CO	CC	31,85	20,80	2,2	
57,2	-	M6x1	70,2	95,0	PA209	UC209G2	CO	CC	31,85	20,80	2,1	45
57,2	-	M6x1	70,2	95,0	PA209	US209G2	CO	CC	31,85	20,80	2,1	
-	63,5	M6x1	84,4	95,0	PA209	ES209G2	COE	CCE	31,85	20,80	2,1	
-	63,5	M6x1	84,4	95,0	PA209	EX209G2	COE	CCE	31,85	20,80	2,3	
-	70,0	M6x1	75,6	100,0	PA210	UK210G2H	CO	CC	35,10	23,20	2,7	
61,8	-	M6x1	75,6	100,0	PA210	UC210G2	CO	CC	35,10	23,20	2,6	50
61,8	-	M6x1	75,6	100,0	PA210	US210G2	CO	CC	35,10	23,20	2,5	
-	69,9	M6x1	91,0	100,0	PA210	ES210G2	COE	CCE	35,10	23,20	2,6	
-	69,9	M6x1	91,0	100,0	PA210	EX210G2	COE	CCE	35,10	23,20	2,8	
-	75,0	M6x1	77,0	110,0	PA211	UK211G2H	CO	CC	43,55	29,20	3,3	
69,0	-	M6x1	77,0	110,0	PA211	UC211G2	CO	CC	43,55	29,20	3,2	55
69,0	-	M6x1	77,0	110,0	PA211	US211G2	CO	CC	43,55	29,20	3,1	
-	76,2	M6x1	103,8	110,0	PA211	ES211G2	COE	CCE	43,55	29,20	2,9	
-	76,2	M6x1	103,8	110,0	PA211	EX211G2	COE	CCE	43,55	29,20	3,5	
-	80,0	M6x1	90,0	120,0	PA212	UK212G2H	CO	CC	52,50	32,80	4,1	
74,9	-	M6x1	90,0	120,0	PA212	UC212G2	CO	CC	52,50	32,80	4,1	60
74,9	-	M6x1	90,0	120,0	PA212	US212G2	CO	CC	52,50	32,80	3,9	
-	84,2	M6x1	111,2	120,0	PA212	ES212G2	COE	CCE	52,50	32,80	3,8	
-	84,2	M6x1	111,2	120,0	PA212	EX212G2	COE	CCE	52,50	32,80	4,5	



→ Four-bolt flanged unit

FE200

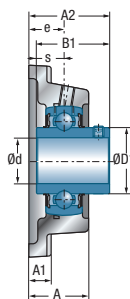
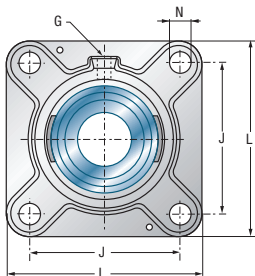
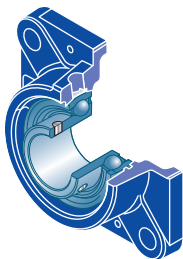

UCFE200

Shaft diameter		Main dimensions [mm]										
Unit		L	J	A	A1	A2	e	N	s1	B	B1	s
12	UCFE201	86	63,5	29,5	10,0	37,3	19,0	11,5	-	-	31,0	12,7
	USFE201	76	54,0	31,0	9,5	33,0	17,0	11,5	-	-	22,0	6,0
	ESFE201	76	54,0	31,0	9,5	39,1	17,0	11,5	-	-	28,6	6,5
	EXFE201	86	63,5	29,5	10,0	45,5	19,0	11,5	-	-	43,5	17,0
15	UCFE202	86	63,5	29,5	10,0	37,3	19,0	11,5	-	-	31,0	12,7
	USFE202	76	54,0	31,0	9,5	33,0	17,0	11,5	-	-	22,0	6,0
	ESFE202	76	54,0	31,0	9,5	39,1	17,0	11,5	-	-	28,6	6,5
	EXFE202	86	63,5	29,5	10,0	45,5	19,0	11,5	-	-	43,5	17,0
17	UCFE203	86	63,5	29,5	10,0	37,3	19,0	11,5	-	-	31,0	12,7
	USFE203	76	54,0	31,0	9,5	33,0	17,0	11,5	-	-	22,0	6,0
	ESFE203	76	54,0	31,0	9,5	39,1	17,0	11,5	-	-	28,6	6,5
	EXFE203	86	63,5	29,5	10,0	45,5	19,0	11,5	-	-	43,5	17,0
20	UCFE204	86	63,5	29,5	10,0	37,3	19,0	11,5	-	-	31,0	12,7
	USFE204	86	63,5	29,5	10,0	37,0	19,0	11,5	-	-	25,0	7,0
	ESFE204	86	63,5	29,5	10,0	42,4	19,0	11,5	-	-	30,9	7,5
	EXFE204	86	63,5	29,5	10,0	45,5	19,0	11,5	-	-	43,5	17,0
	UKFE205H	95	70,0	30,0	11,0	37,5	19,0	11,5	18,5	35,0	-	-
25	UCFE205	95	70,0	30,0	11,0	38,7	19,0	11,5	-	-	34,0	14,3
	USFE205	95	70,0	30,0	11,0	38,5	19,0	11,5	-	-	27,0	7,5
	ESFE205	95	70,0	30,0	11,0	42,4	19,0	11,5	-	-	30,9	7,5
	EXFE205	95	70,0	30,0	11,0	45,9	19,0	11,5	-	-	44,3	17,4
	UKFE206H	108	82,5	33,5	12,0	40,5	20,0	11,5	20,5	38,0	-	-
30	UCFE206	108	82,5	33,5	12,0	42,2	20,0	11,5	-	-	38,1	15,9
	USFE206	108	82,5	33,5	12,0	42,0	20,0	11,5	-	-	30,0	8,0
	ESFE206	108	82,5	33,5	12,0	46,7	20,0	11,5	-	-	35,7	9,0
	EXFE206	108	82,5	33,5	12,0	50,1	20,0	11,5	-	-	48,3	18,2
	UKFE207H	118	92,0	36,0	12,5	43,5	21,0	14,0	22,5	43,0	-	-
35	UCFE207	118	92,0	36,0	12,5	46,4	21,0	14,0	-	-	42,9	17,5
	USFE207	118	92,0	36,0	12,5	44,5	21,0	14,0	-	-	32,0	8,5
	ESFE207	118	92,0	36,0	12,5	50,4	21,0	14,0	-	-	38,9	9,5
	EXFE207	118	92,0	36,0	12,5	53,3	21,0	14,0	-	-	51,1	18,8
	UKFE208H	130	101,5	39,5	13,0	48,5	24,0	14,0	24,5	46,0	-	-

* = equipped with one open protective cap for passing shafts; suffix CO or COE
 ** = equipped with one closed protective cap for shaft ends; suffix CC or CCE

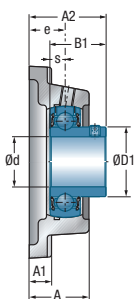

USFE200

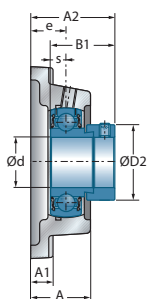

ESFE200

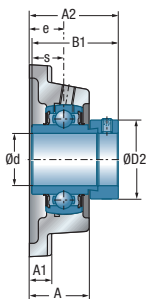

EXFE200

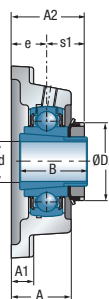

UKFE200H

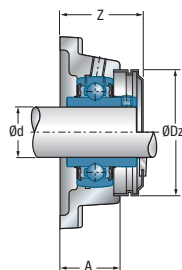

UCFE200CO(CC)

Main dimensions [mm]

Main dimensions [mm]					Housing	Bearing insert	Open protective cap**	Closed protective cap**	Dynamic load rating	Static load rating	Weight	Shaft diameter
D1	D2	G	Z	Dz					C_r [kN]	C_{Or} [kN]	kg	d mm
29,0	-	R1/8"	42,8	54,0	FE204	UC201G2	CO	CC	12,80	6,65	0,7	12
24,6	-	M6x1	42,8	46,0	FE203	US201G2	CO	CC	9,55	4,78	0,4	
-	28,6	M6x1	49,5	46,0	FE203	ES201G2	COE	CCE	9,55	4,78	0,5	
-	33,3	R1/8"	52,0	54,0	FE204	EX201G2	COE	CCE	12,80	6,65	0,8	
29,0	-	R1/8"	42,8	54,0	FE204	UC202G2	CO	CC	12,80	6,65	0,7	15
24,6	-	M6x1	42,8	46,0	FE203	US202G2	CO	CC	9,55	4,78	0,4	
-	28,6	M6x1	49,5	46,0	FE203	ES202G2	COE	CCE	9,55	4,78	0,5	
-	33,3	R1/8"	52,0	54,0	FE204	EX202G2	COE	CCE	12,80	6,65	0,8	
29,0	-	R1/8"	42,8	54,0	FE204	UC203G2	CO	CC	12,80	6,65	0,5	17
24,6	-	M6x1	42,8	46,0	FE203	US203G2	CO	CC	9,55	4,78	0,4	
-	28,6	M6x1	49,5	46,0	FE203	ES203G2	COE	CCE	9,55	4,78	0,5	
-	33,3	R1/8"	52,0	54,0	FE204	EX203G2	COE	CCE	12,80	6,65	0,8	
29,0	-	R1/8"	42,8	54,0	FE204	UC204G2	CO	CC	12,80	6,65	0,7	20
29,0	-	R1/8"	42,8	54,0	FE204	US204G2	CO	CC	12,80	6,65	0,6	
-	33,3	R1/8"	52,0	54,0	FE204	ES204G2	COE	CCE	12,80	6,65	0,7	
-	33,3	R1/8"	52,0	54,0	FE204	EX204G2	COE	CCE	12,80	6,65	0,7	
-	38,0	R1/8"	42,9	60,0	FE205	UK205G2H	CO	CC	14,00	7,88	0,8	
34,0	-	R1/8"	42,9	60,0	FE205	UC205G2	CO	CC	14,00	7,88	0,8	25
34,0	-	R1/8"	42,9	60,0	FE205	US205G2	CO	CC	14,00	7,88	0,8	
-	38,1	R1/8"	51,5	60,0	FE205	ES205G2	COE	CCE	14,00	7,88	0,8	
-	38,1	R1/8"	51,5	60,0	FE205	EX205G2	COE	CCE	14,00	7,88	0,9	
-	45,0	R1/8"	46,9	70,0	FE206	UK206G2H	CO	CC	19,50	11,20	1,2	
40,3	-	R1/8"	46,9	70,0	FE206	UC206G2	CO	CC	19,50	11,20	1,2	30
40,3	-	R1/8"	46,9	70,0	FE206	US206G2	CO	CC	19,50	11,20	1,1	
-	44,5	R1/8"	56,0	70,0	FE206	ES206G2	COE	CCE	19,50	11,20	1,2	
-	44,5	R1/8"	56,0	70,0	FE206	EX206G2	COE	CCE	19,50	11,20	1,3	
-	52,0	R1/8"	50,2	80,0	FE207	UK207G2H	CO	CC	25,70	15,20	1,6	
48,0	-	R1/8"	50,2	80,0	FE207	UC207G2	CO	CC	25,70	15,20	1,6	35
48,0	-	R1/8"	50,2	80,0	FE207	US207G2	CO	CC	25,70	15,20	1,5	
-	55,6	R1/8"	59,5	80,0	FE207	ES207G2	COE	CCE	25,70	15,20	1,6	
-	55,6	R1/8"	59,5	80,0	FE207	EX207G2	COE	CCE	25,70	15,20	1,7	
-	58,0	R1/8"	57,9	88,0	FE208	UK208G2H	CO	CC	29,60	18,20	2,1	





Self-aligning bearing units with cast iron or pressed steel housing

→ Four-bolt flanged unit

FE200

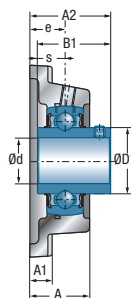
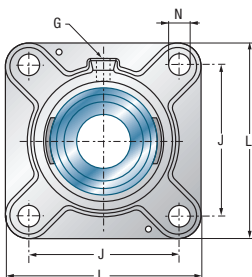
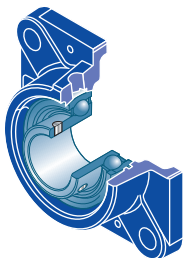

UCFE200

Shaft diameter		Unit		Main dimensions [mm]									
d mm		L	J	A	A1	A2	e	N	s1	B	B1	s	
40	UCFE208	130	101,5	39,5	13,0	54,2	24,0	14,0	-	-	49,2	19,0	
	USFE208	130	101,5	39,5	13,0	49,0	24,0	14,0	-	-	34,0	9,0	
	ESFE208	130	101,5	39,5	13,0	56,7	24,0	14,0	-	-	43,7	11,0	
	EXFE208	130	101,5	39,5	13,0	58,9	24,0	14,0	-	-	56,3	21,4	
	UKFE209H	137	105,0	40,0	13,0	50,0	24,0	14,0	26,0	50,0	-	-	
	45	UCFE209	137	105,0	40,0	13,0	54,2	24,0	14,0	-	-	49,2	19,0
USFE209		137	105,0	40,0	13,0	55,0	24,0	14,0	-	-	41,2	10,2	
ESFE209		137	105,0	40,0	13,0	56,7	24,0	14,0	-	-	43,7	11,0	
EXFE209		137	105,0	40,0	13,0	58,9	24,0	14,0	-	-	56,3	21,4	
UKFE210H		143	111,0	44,0	13,0	55,5	28,0	18,0	27,5	55,0	-	-	
50		UCFE210	143	111,0	44,0	13,0	60,6	28,0	18,0	-	-	51,6	19,0
	USFE210	143	111,0	44,0	13,0	60,6	28,0	18,0	-	-	43,5	10,9	
	ESFE210	143	111,0	44,0	13,0	60,7	28,0	18,0	-	-	43,7	11,0	
	EXFE210	143	111,0	44,0	13,0	66,1	28,0	18,0	-	-	62,7	24,6	
	UKFE211H	162	130,0	48,5	15,0	60,0	31,0	18,0	29,0	59,0	-	-	
	55	UCFE211	162	130,0	48,5	15,0	64,4	31,0	18,0	-	-	55,6	22,2
USFE211		162	130,0	48,5	15,0	64,5	31,0	18,0	-	-	45,3	11,8	
ESFE211		162	130,0	48,5	15,0	67,4	31,0	18,0	-	-	48,4	12,0	
EXFE211		162	130,0	48,5	15,0	74,6	31,0	18,0	-	-	71,3	27,7	
UKFE212H		175	143,0	53,5	16,0	65,0	34,0	18,0	31,0	62,0	-	-	
60		UCFE212	175	143,0	53,5	16,0	73,7	34,0	18,0	-	-	65,1	25,4
	USFE212	175	143,0	53,5	16,0	72,8	34,0	18,0	-	-	53,7	14,9	
	ESFE212	175	143,0	53,5	16,0	71,3	34,0	18,0	-	-	49,3	12,0	
	EXFE212	175	143,0	53,5	16,0	80,8	34,0	18,0	-	-	77,7	30,9	
	UKFE213H	188	150,0	56,0	18,0	70,0	38,0	18,0	32,0	65,0	-	-	
	65	UCFE213	188	150,0	56,0	18,0	77,7	38,0	18,0	-	-	65,1	25,4
EXFE213		188	150,0	56,0	18,0	89,6	38,0	18,0	-	-	85,7	34,1	
UKFE215H		197	153,0	59,0	20,0	76,8	41,3	23,0	35,5	73,0	-	-	
70	UCFE214	188	150,0	56,0	18,0	82,4	38,0	18,0	-	-	74,6	30,2	
	EXFE214	188	150,0	56,0	18,0	89,6	38,0	18,0	-	-	85,7	34,1	
	UKFE216H	197	153,0	61,0	20,0	80,3	41,3	23,0	39,0	78,0	-	-	

* = equipped with one open protective cap for passing shafts; suffix CO or COE
 ** = equipped with one closed protective cap for shaft ends; suffix CC or CCE

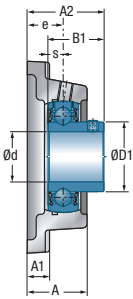

USFE200

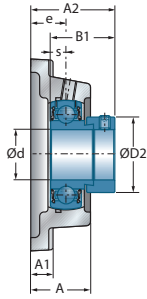

ESFE200

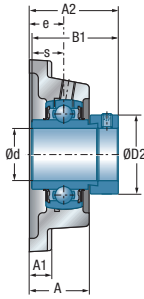

EXFE200

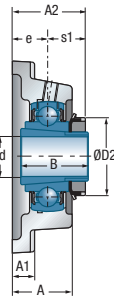

UKFE200H

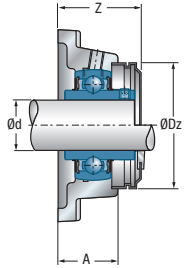

UCFE200C0(CC)

Main dimensions [mm]

Main dimensions [mm]					Housing	Bearing insert	Open protective cap*	Closed protective cap**	Dynamic load rating	Static load rating	Weight	Shaft diameter
D1	D2	G	Z	Dz					C_r [kN]	C_{0r} [kN]	kg	d mm
53,0	-	R1/8"	57,9	88,0	FE208	UC208G2	CO	CC	29,60	18,20	2,1	40
53,0	-	R1/8"	57,9	88,0	FE208	US208G2	CO	CC	29,60	18,20	2,0	
-	60,3	R1/8"	64,0	88,0	FE208	ES208G2	COE	CCE	29,60	18,20	2,1	
-	60,3	R1/8"	64,0	88,0	FE208	EX208G2	COE	CCE	29,60	18,20	2,2	
-	65,0	R1/8"	58,4	95,0	FE209	UK209G2H	CO	CC	31,85	20,80	2,4	
57,2	-	R1/8"	58,4	95,0	FE209	UC209G2	CO	CC	31,85	20,80	2,2	45
57,2	-	R1/8"	58,4	95,0	FE209	US209G2	CO	CC	31,85	20,80	2,2	
-	63,5	R1/8"	65,5	95,0	FE209	ES209G2	COE	CCE	31,85	20,80	2,2	
-	63,5	R1/8"	65,5	95,0	FE209	EX209G2	COE	CCE	31,85	20,80	2,4	
-	70,0	R1/8"	65,8	100,0	FE210	UK210G2H	CO	CC	35,10	23,20	2,7	
61,8	-	R1/8"	65,8	100,0	FE210	UC210G2	CO	CC	35,10	23,20	2,6	50
61,8	-	R1/8"	65,8	100,0	FE210	US210G2	CO	CC	35,10	23,20	2,5	
-	69,9	R1/8"	73,5	100,0	FE210	ES210G2	COE	CCE	35,10	23,20	2,6	
-	69,9	R1/8"	73,5	100,0	FE210	EX210G2	COE	CCE	35,10	23,20	2,8	
-	75,0	R1/8"	69,1	110,0	FE211	UK211G2H	CO	CC	43,55	29,20	3,7	
69,0	-	R1/8"	69,1	110,0	FE211	UC211G2	CO	CC	43,55	29,20	3,7	55
69,0	-	R1/8"	69,1	110,0	FE211	US211G2	CO	CC	43,55	29,20	3,6	
-	76,2	R1/8"	82,5	110,0	FE211	ES211G2	COE	CCE	43,55	29,20	3,4	
-	76,2	R1/8"	82,5	110,0	FE211	EX211G2	COE	CCE	43,55	29,20	3,9	
-	80,0	R1/8"	78,4	120,0	FE212	UK212G2H	CO	CC	52,50	32,80	4,9	
74,9	-	R1/8"	78,4	120,0	FE212	UC212G2	CO	CC	52,50	32,80	4,9	60
74,9	-	R1/8"	78,4	120,0	FE212	US212G2	CO	CC	52,50	32,80	4,7	
-	84,2	R1/8"	89,0	120,0	FE212	ES212G2	COE	CCE	52,50	32,80	4,6	
-	84,2	R1/8"	89,0	120,0	FE212	EX212G2	COE	CCE	52,50	32,80	5,2	
-	85,0	R1/8"	77,4	132,0	FE213	UK213G2H	CO	CC	57,20	40,00	6,1	
82,0	-	R1/8"	77,4	132,0	FE213	UC213G2	CO	CC	57,20	40,00	6,0	65
-	86,0	R1/8"	92,0	132,0	FE213	EX213G2	COE	CCE	57,20	40,00	6,6	
-	98,0	R1/8"	-	-	FE215	UK215G2H	-	-	66,00	49,50	6,9	
86,5	-	R1/8"	-	-	FE214	UC214G2	-	-	62,00	45,00	6,2	70
-	96,8	R1/8"	-	-	FE214	EX214G2	-	-	62,00	45,00	6,7	
-	105,0	R1/8"	-	-	FE216	UK216G2H	-	-	72,50	54,20	7,5	



→ Four-bolt flanged unit

FE200

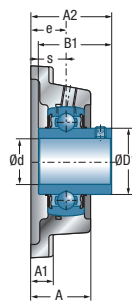
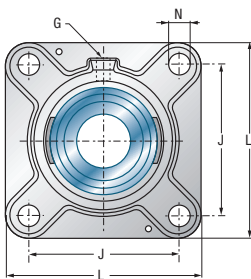
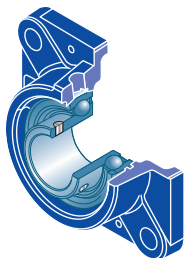

UCCE200

Shaft diameter		Unit		Main dimensions [mm]								
d mm		L	J	A	A1	A2	e	N	s1	B	B1	s
75	UCFE215	197	153,0	59,0	20,0	85,8	41,3	23,0	-	-	77,8	33,3
	EXFE215	197	153,0	59,0	20,0	96,1	41,3	23,0	-	-	92,1	37,3
80	UCFE216	197	153,0	61,0	20,0	90,6	41,3	23,0	-	-	82,6	33,3
	EXFE216	197	153,0	61,0	20,0	99,2	41,3	23,0	-	-	95,2	37,3
	UKFE218H	235	187,0	45,0	22,0	65,8	23,8	23,0	42,0	86,0	-	-
90	UCFE218	235	187,0	45,0	22,0	80,1	23,8	23,0	-	-	96,0	39,7
	EXFE218	235	187,0	45,0	22,0	70,3	23,8	23,0	-	-	72,5	24,5

* = equipped with one open protective cap for passing shafts: suffix CO or COE
 ** = equipped with one closed protective cap for shaft ends: suffix CC or CCE

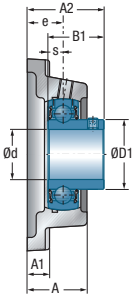

USFE200

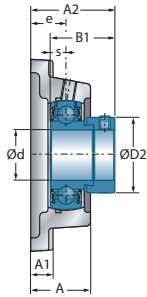

ESFE200

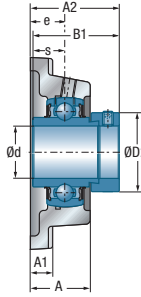

EXFE200

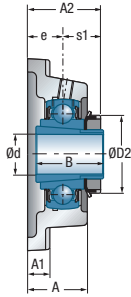

UKFE200H

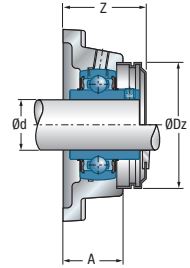

UCFE200CO(CC)

Main dimensions [mm]

Main dimensions [mm]					Housing	Bearing insert	Open protective cap*	Closed protective cap**	Dynamic load rating	Static load rating	Weight	Shaft diameter
D1	D2	G	Z	Dz					C _r [kN]	C _{0r} [kN]	kg	d mm
91,5	-	R1/8"	-	-	FE215	UC215G2	-	-	66,00	49,50	6,3	75
-	102,0	R1/8"	-	-	FE215	EX215G2	-	-	66,00	49,50	6,9	
98,0	-	R1/8"	-	-	FE216	UC216G2	-	-	72,50	54,20	7,1	80
-	110,0	R1/8"	-	-	FE216	EX216G2	-	-	72,50	54,20	7,4	
-	120,0	R1/8"	-	-	FE218	UK218G2H	-	-	96,00	71,50	10,7	
111,0	-	R1/8"	-	-	FE218	UC218G2	-	-	96,00	71,50	10,4	90
-	120,0	R1/8"	-	-	FE218	EX218G2	-	-	96,00	71,50	10,9	





Self-aligning bearing units with cast iron or pressed steel housing

→ Four-bolt flanged unit

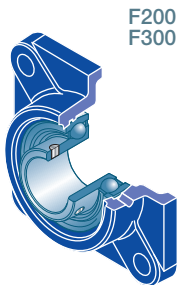

F200
F300

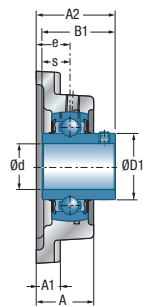
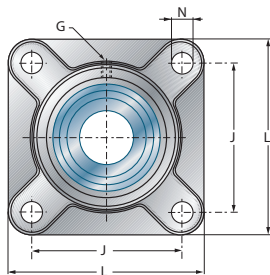

UCF200 UCF300

Shaft diameter		Unit		Main dimensions [mm]									
d mm		L	J	A	A1	A2	e	N	s1	B	B1	s	
12	UCF201	86	64	25,5	11	33,3	15	12	-	-	31,0	12,7	
	USF201	76	54	25,5	11	31,0	15	12	-	-	22,0	6,0	
	ESF201	76	54	25,5	11	37,1	15	12	-	-	28,6	6,5	
	EXF201	86	64	25,5	11	41,5	15	12	-	-	43,5	17,0	
15	UCF202	86	64	25,5	11	33,3	15	12	-	-	31,0	12,7	
	USF202	76	54	25,5	11	31,0	15	12	-	-	22,0	6,0	
	ESF202	76	54	25,5	11	37,1	15	12	-	-	28,6	6,5	
	EXF202	86	64	25,5	11	41,5	15	12	-	-	43,5	17,0	
17	UCF203	86	64	25,5	11	33,3	15	12	-	-	31,0	12,7	
	USF203	76	54	25,5	11	31,0	15	12	-	-	22,0	6,0	
	ESF203	76	54	25,5	11	37,1	15	12	-	-	28,6	6,5	
	EXF203	86	64	25,5	11	41,5	15	12	-	-	43,5	17,0	
20	UCF204	86	64	25,5	11	33,3	15	12	-	-	31,0	12,7	
	USF204	86	64	25,5	11	33,0	15	12	-	-	25,0	7,0	
	ESF204	86	64	25,5	11	38,4	15	12	-	-	30,9	7,5	
	EXF204	86	64	25,5	11	41,5	15	12	-	-	43,5	17,0	
	UKF205H	95	70	27,0	13	34,5	16	12	18,5	35,0	-	-	
	UKF305H	108	80	29,0	13	37,5	16	16	21,5	35,0	-	-	
25	UCF205	95	70	27,0	13	35,7	16	12	-	-	34,0	14,3	
	USF205	95	70	27,0	13	35,5	16	12	-	-	27,0	7,5	
	ESF205	95	70	27,0	13	39,4	16	12	-	-	30,9	7,5	
	EXF205	95	70	27,0	13	42,9	16	12	-	-	44,3	17,4	
	UKF206H	108	83	31,0	13	38,5	18	12	20,5	38,0	-	-	
	UCF305	108	80	29,0	13	39,0	16	16	-	-	38,0	15,0	
	EXF305	108	80	29,0	13	46,1	16	16	-	-	46,8	16,7	
	UKF306H	125	95	32,0	15	41,0	18	16	23,0	38,0	-	-	
30	UCF206	108	83	31,0	13	40,2	18	12	-	-	38,1	15,9	
	USF206	108	83	31,0	13	40,0	18	12	-	-	30,0	8,0	
	ESF206	108	83	31,0	13	44,7	18	12	-	-	35,7	9,0	
	EXF206	108	83	31,0	13	48,1	18	12	-	-	48,3	18,2	
	UKF207H	117	92	34,0	15	41,5	19	14	22,5	43,0	-	-	
	UCF306	125	95	32,0	15	44,0	18	16	-	-	43,0	17,0	
	EXF306	125	95	32,0	15	50,5	18	16	-	-	50,0	17,5	
	UKF307H	135	100	36,0	16	45,5	20	19	25,5	43,0	-	-	

* = equipped with one open protective cap for passing shafts; suffix CO or COE
 ** = equipped with one closed protective cap for shaft ends; suffix CC or CCE

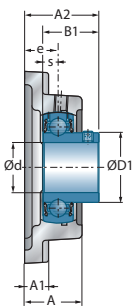

USF200

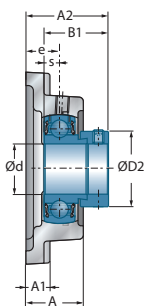

ESF200

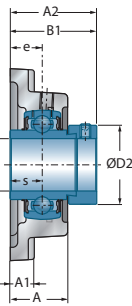

EXF200 EXF300

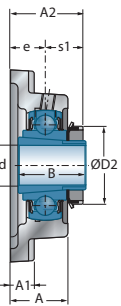

UKF200H UKF300H

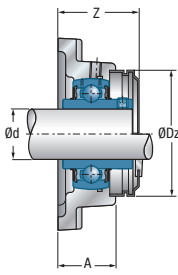

UCF200CO(C)

Main dimensions [mm]

Main dimensions [mm]					Housing	Bearing insert	Open protective cap*	Closed protective cap**	Dynamic load rating	Static load rating	Weight	Shaft diameter
D1	D2	G	Z	Dz					C _r [kN]	C _{0r} [kN]	kg	d mm
29,0	-	M6x1	36,6	54,0	F204	UC201G2	CO	CC	12,80	6,65	0,6	12
24,6	-	M6x1	36,3	46,0	F203	US201G2	CO	CC	9,55	4,78	0,4	
-	28,6	M6x1	43,0	46,0	F203	ES201G2	COE	CCE	9,55	4,78	0,5	
-	33,3	M6x1	45,8	54,0	F204	EX201G2	COE	CCE	12,80	6,65	0,7	
29,0	-	M6x1	36,6	54,0	F204	UC202G2	CO	CC	12,80	6,65	0,6	15
24,6	-	M6x1	36,3	46,0	F203	US202G2	CO	CC	9,55	4,78	0,4	
-	28,6	M6x1	43,0	46,0	F203	ES202G2	COE	CCE	9,55	4,78	0,5	
-	33,3	M6x1	45,8	54,0	F204	EX202G2	COE	CCE	12,80	6,65	0,7	
29,0	-	M6x1	36,6	54,0	F204	UC203G2	CO	CC	12,80	6,65	0,5	17
24,6	-	M6x1	36,3	46,0	F203	US203G2	CO	CC	9,55	4,78	0,4	
-	28,6	M6x1	43,0	46,0	F203	ES203G2	COE	CCE	9,55	4,78	0,5	
-	33,3	M6x1	45,8	54,0	F204	EX203G2	COE	CCE	12,80	6,65	0,7	
29,0	-	M6x1	36,6	54,0	F204	UC204G2	CO	CC	12,80	6,65	0,6	20
29,0	-	M6x1	36,6	54,0	F204	US204G2	CO	CC	12,80	6,65	0,6	
-	33,3	M6x1	45,8	54,0	F204	ES204G2	COE	CCE	12,80	6,65	0,6	
-	33,3	M6x1	45,8	54,0	F204	EX204G2	COE	CCE	12,80	6,65	0,7	
-	38,0	M6x1	39,2	60,0	F205	UK205G2H	CO	CC	14,00	7,88	0,8	
-	38,0	M6x1	-	-	F305	UK305G2H	-	-	22,36	11,50	1,2	
-	-	-	-	-	-	-	-	-	-	-	-	
34,0	-	M6x1	39,2	60,0	F205	UC205G2	CO	CC	14,00	7,88	0,8	25
34,0	-	M6x1	39,2	60,0	F205	US205G2	CO	CC	14,00	7,88	0,8	
-	38,1	M6x1	47,8	60,0	F205	ES205G2	COE	CCE	14,00	7,88	0,8	
-	38,1	M6x1	47,8	60,0	F205	EX205G2	COE	CCE	14,00	7,88	0,9	
-	45,0	M6x1	44,2	70,0	F206	UK206G2H	CO	CC	19,50	11,20	1,2	
35,4	-	M6x1	-	-	F305	UC305G2	-	-	22,36	11,50	1,1	
-	42,8	M6x1	-	-	F305	EX305G2	-	-	22,36	11,50	1,2	
-	45,0	M6x1	-	-	F306	UK306G2H	-	-	27,00	15,20	1,6	
40,3	-	M6x1	44,2	70,0	F206	UC206G2	CO	CC	19,50	11,20	1,1	30
40,3	-	M6x1	44,2	70,0	F206	US206G2	CO	CC	19,50	11,20	1,1	
-	44,5	M6x1	53,3	70,0	F206	ES206G2	COE	CCE	19,50	11,20	1,1	
-	44,5	M6x1	53,3	70,0	F206	EX206G2	COE	CCE	19,50	11,20	1,2	
-	52,0	M6x1	48,3	80,0	F207	UK207G2H	CO	CC	25,70	15,20	1,6	
44,6	-	M6x1	-	-	F306	UC306G2	-	-	27,00	15,20	1,6	
-	50,0	M6x1	-	-	F306	EX306G2	-	-	27,00	15,20	1,7	
-	52,0	M6x1	-	-	F307	UK307G2H	-	-	33,50	19,20	2,2	





Self-aligning bearing units with cast iron or pressed steel housing

→ Four-bolt flanged unit

F200
F300

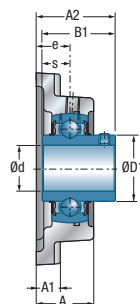
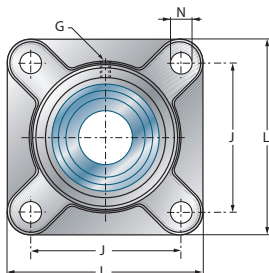

UCF200 UCF300

Shaft diameter		Unit		Main dimensions [mm]								
d mm		L	J	A	A1	A2	e	N	s1	B	B1	s
35	UCF207	117	92	34,0	15	44,4	19	14	-	-	42,9	17,5
	USF207	117	92	34,0	15	42,5	19	14	-	-	32,0	8,5
	ESF207	117	92	34,0	15	48,4	19	14	-	-	38,9	9,5
	EXF207	117	92	34,0	15	51,3	19	14	-	-	51,1	18,8
	UKF208H	130	102	36,0	15	45,5	21	16	24,5	46,0	-	-
	UCF307	135	100	36,0	16	49,0	20	19	-	-	48,0	19,0
	EXF307	135	100	36,0	16	53,3	20	19	-	-	51,6	18,3
	UKF308H	150	112	40,0	17	50,5	23	19	27,5	46,0	-	-
40	UCF208	130	102	36,0	15	51,2	21	16	-	-	49,2	19,0
	USF208	130	102	36,0	15	46,0	21	16	-	-	34,0	9,0
	ESF208	130	102	36,0	15	53,7	21	16	-	-	43,7	11,0
	EXF208	130	102	36,0	15	55,9	21	16	-	-	56,3	21,4
	UKF209H	137	105	38,0	16	48,0	22	16	26,0	50,0	-	-
	UCF308	150	112	40,0	17	56,0	23	19	-	-	52,0	19,0
	EXF308	150	112	40,0	17	60,3	23	19	-	-	57,1	19,8
	UKF309H	160	125	44,0	18	55,0	25	19	30,0	50,0	-	-
45	UCF209	137	105	38,0	16	52,2	22	16	-	-	49,2	19,0
	USF209	137	105	38,0	16	53,0	22	16	-	-	41,2	10,2
	ESF209	137	105	38,0	16	54,7	22	16	-	-	43,7	11,0
	EXF209	137	105	38,0	16	56,9	22	16	-	-	56,3	21,4
	UKF210H	143	111	40,0	16	49,5	22	16	27,5	55,0	-	-
	UCF309	160	125	44,0	18	60,0	25	19	-	-	57,0	22,0
	EXF309	160	125	44,0	18	63,9	25	19	-	-	58,7	19,8
	UKF310H	175	132	48,0	20	60,0	28	23	32,0	55,0	-	-
50	UCF210	143	111	40,0	16	54,6	22	16	-	-	51,6	19,0
	USF210	143	111	40,0	16	54,6	22	16	-	-	43,5	10,9
	ESF210	143	111	40,0	16	54,7	22	16	-	-	43,7	11,0
	EXF210	143	111	40,0	16	60,1	22	16	-	-	62,7	24,6
	UKF211H	162	130	43,0	18	54,0	25	19	29,0	59,0	-	-
	UCF310	175	132	48,0	20	67,0	28	23	-	-	61,0	22,0
	EXF310	175	132	48,0	20	70,0	28	23	-	-	66,6	24,6
	UKF311H	185	140	52,0	20	64,0	30	23	34,0	59,0	-	-

* = equipped with one open protective cap for passing shafts; suffix CO or COE
 ** = equipped with one closed protective cap for shaft ends; suffix CC or CCE

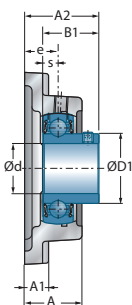

USF200

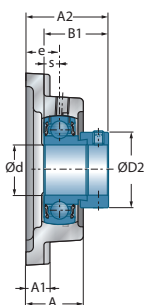

ESF200

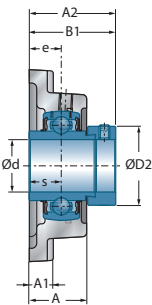

EXF200 EXF300

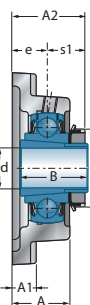

UKF200H UKF300H

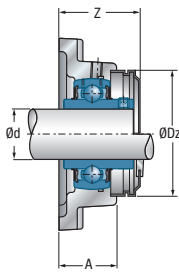

UCF200CO(C)

Main dimensions [mm]

Main dimensions [mm]					Housing	Bearing insert	Open protective cap*	Closed protective cap**	Dynamic load rating	Static load rating	Weight	Shaft diameter
D1	D2	G	Z	Dz					C_r [kN]	C_{Or} [kN]	kg	d mm
48,0	-	M6x1	48,3	80,0	F207	UC207G2	CO	CC	25,70	15,20	1,5	35
48,0	-	M6x1	48,3	80,0	F207	US207G2	CO	CC	25,70	15,20	1,5	
-	55,6	M6x1	57,6	80,0	F207	ES207G2	COE	CCE	25,70	15,20	1,5	
-	55,6	M6x1	57,6	80,0	F207	EX207G2	COE	CCE	25,70	15,20	1,6	
-	58,0	M6x1	55,2	88,0	F208	UK208G2H	CO	CC	29,60	18,20	2,0	
48,9	-	M6x1	-	-	F307	UC307G2	-	-	33,50	19,20	2,0	
-	55,0	M6x1	-	-	F307	EX307G2	-	-	33,50	19,20	2,1	
-	58,0	M6x1	-	-	F308	UK308G2H	-	-	40,56	24,00	2,8	
53,0	-	M6x1	55,2	88,0	F208	UC208G2	CO	CC	29,60	18,20	1,9	40
53,0	-	M6x1	55,2	88,0	F208	US208G2	CO	CC	29,60	18,20	1,9	
-	60,3	M6x1	61,3	88,0	F208	ES208G2	COE	CCE	29,60	18,20	1,9	
-	60,3	M6x1	61,3	88,0	F208	EX208G2	COE	CCE	29,60	18,20	2,1	
-	65,0	M6x1	56,3	95,0	F209	UK209G2H	CO	CC	31,85	20,80	2,3	
56,5	-	M6x1	-	-	F308	UC308G2	-	-	40,56	24,00	2,7	
-	63,5	M6x1	-	-	F308	EX308G2	-	-	40,56	24,00	2,8	
-	65,0	M6x1	-	-	F309	UK309G2H	-	-	53,00	31,80	3,5	
57,2	-	M6x1	56,3	95,0	F209	UC209G2	CO	CC	31,85	20,80	2,1	45
57,2	-	M6x1	56,3	95,0	F209	US209G2	CO	CC	31,85	20,80	2,1	
-	63,5	M6x1	63,4	95,0	F209	ES209G2	COE	CCE	31,85	20,80	2,1	
-	63,5	M6x1	63,4	95,0	F209	EX209G2	COE	CCE	31,85	20,80	2,3	
-	70,0	M6x1	59,3	100,0	F210	UK210G2H	CO	CC	35,10	23,20	2,7	
61,8	-	M6x1	-	-	F309	UC309G2	-	-	53,00	31,80	3,3	
-	70,0	M6x1	-	-	F309	EX309G2	-	-	53,00	31,80	3,5	
-	70,0	M6x1	-	-	F310	UK310G2H	-	-	62,00	37,80	4,5	
61,8	-	M6x1	59,3	100,0	F210	UC210G2	CO	CC	35,10	23,20	2,5	50
61,8	-	M6x1	59,3	100,0	F210	US210G2	CO	CC	35,10	23,20	2,5	
-	69,9	M6x1	67,0	100,0	F210	ES210G2	COE	CCE	35,10	23,20	2,5	
-	69,9	M6x1	67,0	100,0	F210	EX210G2	COE	CCE	35,10	23,20	2,7	
-	75,0	M6x1	62,8	110,0	F211	UK211G2H	CO	CC	43,55	29,20	3,4	
68,7	-	M6x1	-	-	F310	UC310G2	-	-	62,00	37,80	4,4	
-	76,2	M6x1	-	-	F310	EX310G2	-	-	62,00	37,80	4,6	
-	75,0	M6x1	-	-	F311	UK311G2H	-	-	71,50	44,80	5,5	



→ Four-bolt flanged unit

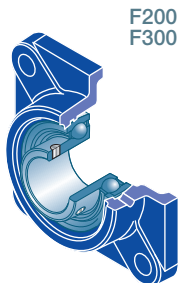

F200
F300

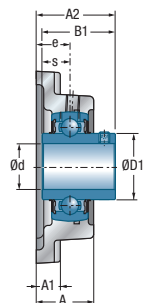
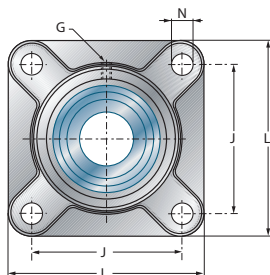

UCF200 UCF300

Shaft diameter		Unit		Main dimensions [mm]								
d mm		L	J	A	A1	A2	e	N	s1	B	B1	s
55	UCF211	162	130	43,0	18	58,4	25	19	-	-	55,6	22,2
	USF211	162	130	43,0	18	58,5	25	19	-	-	45,3	11,8
	ESF211	162	130	43,0	18	61,4	25	19	-	-	48,4	12,0
	EXF211	162	130	43,0	18	68,6	25	19	-	-	71,3	27,7
	UKF212H	175	143	48,0	18	60,0	29	19	31,0	62,0	-	-
	UCF311	185	140	52,0	20	71,0	30	23	-	-	66,0	25,0
	EXF311	185	140	52,0	20	75,2	30	23	-	-	73,0	27,8
	UKF312H	193	150	56,0	22	69,5	33	23	36,5	62,0	-	-
60	UCF212	175	143	48,0	18	68,7	29	19	-	-	65,1	25,4
	USF212	175	143	48,0	18	67,8	29	19	-	-	53,7	14,9
	ESF212	175	143	48,0	18	66,3	29	19	-	-	49,3	12,0
	EXF212	175	143	48,0	18	75,8	29	19	-	-	77,7	30,9
	UKF213H	187	149	50,0	22	62,0	30	19	32,0	65,0	-	-
	UCF312	193	150	56,0	22	78,0	33	23	-	-	71,0	26,0
	EXF312	193	150	56,0	22	81,5	33	23	-	-	79,4	31,0
	UKF313H	208	166	58,0	22	71,5	33	23	38,5	65,0	-	-
65	UCF213	187	149	50,0	22	69,7	30	19	-	-	65,1	25,4
	EXF213	187	149	50,0	22	81,6	30	19	-	-	85,7	34,1
	UKF215H	200	159	56,0	22	69,5	34	19	35,5	73,0	-	-
	UCF313	208	166	58,0	22	78,0	33	23	-	-	75,0	30,0
	EXF313	208	166	58,0	22	86,2	33	23	-	-	85,7	32,5
	UKF315H	236	184	66,0	25	81,5	39	25	42,5	73,0	-	-
70	UCF214	193	152	54,0	22	75,4	31	19	-	-	74,6	30,2
	EXF214	193	152	54,0	22	82,6	31	19	-	-	85,7	34,1
	UKF216H	208	165	57,0	22	73,0	34	23	39,0	78,0	-	-
	UCF314	226	178	61,0	25	83,0	36	25	-	-	78,0	33,0
	EXF314	226	178	61,0	25	94,0	36	25	-	-	92,1	34,2
	UKF316H	250	196	68,0	27	82,5	38	31	44,5	78,0	-	-
75	UCF215	200	159	56,0	22	78,5	34	19	-	-	77,8	33,3
	EXF215	200	159	56,0	22	88,8	34	19	-	-	92,1	37,3
	UKF217H	220	175	63,0	24	76,0	36	23	40,0	82,0	-	-
	UCF315	236	184	66,0	25	89,0	39	25	-	-	82,0	32,0
	EXF315	236	184	66,0	25	101,7	39	25	-	-	100,0	37,3
	UKF317H	260	204	74,0	27	92,0	44	31	48,0	82,0	-	-

* = equipped with one open protective cap for passing shafts; suffix CO or COE
 ** = equipped with one closed protective cap for shaft ends; suffix CC or CCE

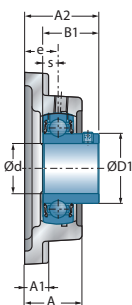

USF200

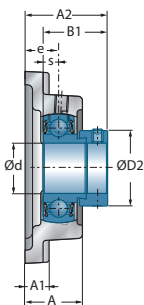

ESF200

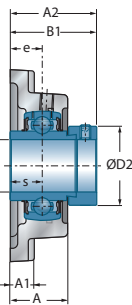

EXF200 EXF300

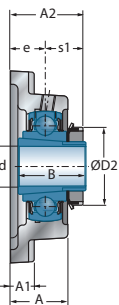

UKF200H UKF300H

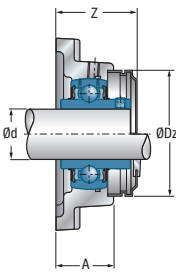

UCF200CO(C)

Main dimensions [mm]

Main dimensions [mm]					Housing	Bearing insert	Open protective cap*	Closed protective cap**	Dynamic load rating	Static load rating	Weight	Shaft diameter	
D1	D2	G	Z	Dz					C _r [kN]	C _{0r} [kN]	kg	d mm	
69,0	-	M6x1	62,8	110,0	F211	UC211G2	CO	CC	43,55	29,20	3,4	55	
69,0	-	M6x1	62,8	110,0	F211	US211G2	CO	CC	43,55	29,20	3,3		
-	76,2	M6x1	76,2	110,0	F211	ES211G2	COE	CCE	43,55	29,20	3,1		
-	76,2	M6x1	76,2	110,0	F211	EX211G2	COE	CCE	43,55	29,20	3,6		
-	80,0	M6x1	73,2	120,0	F212	UK212G2H	CO	CC	52,50	32,80	4,4		
74,9	-	M6x1	-	-	F311	UC311G2	-	-	71,50	44,80	5,2		
-	83,0	M6x1	-	-	F311	EX311G2	-	-	71,50	44,80	5,6		
-	80,0	M6x1	-	-	F312	UK312G2H	-	-	81,60	51,80	6,3		
74,9	-	M6x1	73,2	120,0	F212	UC212G2	CO	CC	52,50	32,80	4,4		60
74,9	-	M6x1	73,2	120,0	F212	US212G2	CO	CC	52,50	32,80	4,2		
-	84,2	M6x1	83,8	120,0	F212	ES212G2	COE	CCE	52,50	32,80	4,1		
-	84,2	M6x1	83,8	120,0	F212	EX212G2	COE	CCE	52,50	32,80	4,8		
-	85,0	M6x1	74,3	132,0	F213	UK213G2H	CO	CC	57,20	40,00	5,6		
81,0	-	M6x1	-	-	F312	UC312G2	-	-	81,60	51,80	6,4		
-	89,0	M6x1	-	-	F312	EX312G2	-	-	81,60	51,80	6,7		
-	85,0	M6x1	-	-	F313	UK313G2H	-	-	93,86	60,50	7,9		
82,0	-	M6x1	74,3	132,0	F213	UC213G2	CO	CC	57,20	40,00	5,6	65	
-	86,0	M6x1	88,9	132,0	F213	EX213G2	COE	CCE	57,20	40,00	6,1		
-	98,0	M10x1	-	-	F215	UK215G2H	-	-	66,00	49,50	6,4		
87,5	-	M6x1	-	-	F313	UC313G2	-	-	93,86	60,50	7,9		
-	97,0	M6x1	-	-	F313	EX313G2	-	-	93,86	60,50	8,3		
-	98,0	M10x1	-	-	F315	UK315G2H	-	-	113,36	76,80	11,1		
86,5	-	M10x1	-	-	F214	UC214G2	-	-	62,00	45,00	6,3		70
-	96,8	M10x1	-	-	F214	EX214G2	-	-	62,00	45,00	6,8		
-	105,0	M10x1	-	-	F216	UK216G2H	-	-	72,50	54,20	7,4		
94,0	-	M10x1	-	-	F314	UC314G2	-	-	104,26	68,00	9,5		
-	102,0	M10x1	-	-	F314	EX314G2	-	-	104,26	68,00	10,0		
-	105,0	M10x1	-	-	F316	UK316G2H	-	-	122,85	86,50	13,0		
91,5	-	M10x1	-	-	F215	UC215G2	-	-	66,00	49,50	5,8	75	
-	102,0	M10x1	-	-	F215	EX215G2	-	-	66,00	49,50	6,5		
-	110,0	M10x1	-	-	F217	UK217G2H	-	-	83,20	63,80	9,2		
100,5	-	M10x1	-	-	F315	UC315G2	-	-	113,36	76,80	10,4		
-	113,0	M10x1	-	-	F315	EX315G2	-	-	113,36	76,80	11,4		
-	110,0	M10x1	-	-	F317	UK317G2H	-	-	132,60	96,50	15,7		



→ Four-bolt flanged unit

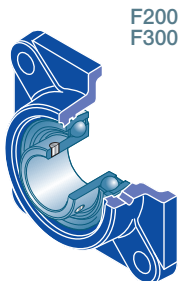

F200
F300

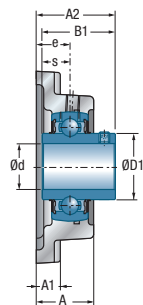
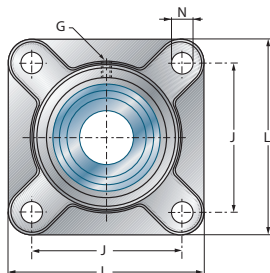

UCF200
UCF300

Shaft diameter		Unit		Main dimensions [mm]								
d mm		L	J	A	A1	A2	e	N	s1	B	B1	s
80	UCF216	208	165	57,0	22	83,3	34	23	-	-	82,6	33,3
	EXF216	208	165	57,0	22	91,9	34	23	-	-	95,2	37,3
	UKF218H	235	187	68,0	25	82,0	40	23	42,0	86,0	-	-
	UCF316	250	196	68,0	27	90,0	38	31	-	-	86,0	34,0
	EXF316	250	196	68,0	27	103,9	38	31	-	-	106,4	40,5
	UKF318H	280	216	76,0	30	92,0	44	35	48,0	86,0	-	-
85	UCF217	220	175	63,0	24	87,6	36	23	-	-	85,7	34,1
	EXF217	220	175	63,0	24	83,6	36	23	-	-	73,2	23,4
	UCF317	260	204	74,0	27	100,0	44	31	-	-	96,0	40,0
	EXF317	260	204	74,0	27	111,5	44	31	-	-	109,5	42,0
	UKF319H	290	228	94,0	30	111,0	59	35	52,0	90,0	-	-
	90	UCF218	235	187	68,0	25	96,3	40	23	-	-	96,0
EXF218		235	187	68,0	25	86,5	40	23	-	-	72,5	24,5
UCF318		280	216	76,0	30	100,0	44	35	-	-	96,0	40,0
EXF318		280	216	76,0	30	116,3	44	35	-	-	115,9	43,6
UKF320H		310	242	94,0	32	113,0	59	38	54,0	97,0	-	-
95		UCF319	290	228	94,0	30	121,0	59	35	-	-	103,0
	EXF319	290	228	94,0	30	134,5	59	35	-	-	122,3	46,8
100	UCF320	310	242	94,0	32	125,0	59	38	-	-	108,0	42,0
	EXF320	310	242	94,0	32	137,6	59	38	-	-	128,6	50,0
	UKF322H	340	266	96,0	35	121,0	60	41	61,0	105,0	-	-
105	UCF321	310	242	94,0	32	127,0	59	38	-	-	112,0	44,0
110	UCF322	340	266	96,0	35	131,0	60	41	-	-	117,0	46,0
	UKF324H	370	290	110,0	40	130,0	65	41	65,0	112,0	-	-
115	UKF326H	410	320	115,0	45	134,0	65	41	69,0	121,0	-	-
120	UCF324	370	290	110,0	40	140,0	65	41	-	-	126,0	51,0
125	UKF328H	450	350	125,0	55	148,0	75	41	73,0	131,0	-	-
130	UCF326	410	320	115,0	45	146,0	65	41	-	-	135,0	54,0
140	UCF328	450	350	125,0	55	161,0	75	41	-	-	145,0	59,0

* = equipped with one open protective cap for passing shafts: suffix CO or COE
 ** = equipped with one closed protective cap for shaft ends: suffix CC or CCE

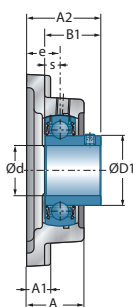

USF200

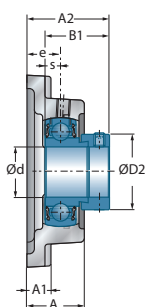

ESF200

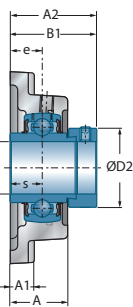

EXF200 EXF300

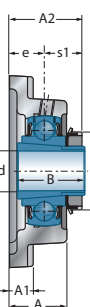

UKF200H UKF300H

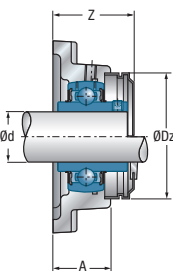

UCF200CO(C)

Main dimensions [mm]

Main dimensions [mm]					Housing	Bearing insert	Open protective cap*	Closed protective cap**	Dynamic load rating	Static load rating	Weight	Shaft diameter
D1	D2	G	Z	Dz				C _r [kN]	C _{0r} [kN]	kg	d mm	
98,0	-	M10x1	-	-	F216	UC216G2	-	72,50	54,20	7,0	80	
-	110,0	M10x1	-	-	F216	EX216G2	-	72,50	54,20	7,3		
-	120,0	M10x1	-	-	F218	UK218G2H	-	96,00	71,50	11,8		
107,9	-	M10x1	-	-	F316	UC316G2	-	122,85	86,50	12,8		
-	119,0	M10x1	-	-	F316	EX316G2	-	122,85	86,50	13,9		
-	120,0	M10x1	-	-	F318	UK318G2H	-	143,00	108,00	18,1		
105,1	-	M10x1	-	-	F217	UC217G2	-	83,20	63,80	8,8	85	
-	119,0	M10x1	-	-	F217	EX217G2	-	83,20	63,80	9,1		
114,0	-	M10x1	-	-	F317	UC317G2	-	132,60	96,50	15,7		
-	127,0	M10x1	-	-	F317	EX317G2	-	132,60	96,50	16,8		
-	125,0	M10x1	-	-	F319	UK319G2H	-	156,00	122,00	21,6		
111,0	-	M10x1	-	-	F218	UC218G2	-	96,00	71,50	11,6	90	
-	120,0	M10x1	-	-	F218	EX218G2	-	96,00	71,50	12,1		
120,0	-	M10x1	-	-	F318	UC318G2	-	143,00	108,00	18,1		
-	133,0	M10x1	-	-	F318	EX318G2	-	143,00	108,00	19,3		
-	130,0	M10x1	-	-	F320	UK320G2H	-	171,60	140,00	25,6		
126,5	-	M10x1	-	-	F319	UC319G2	-	156,00	122,00	21,3	95	
-	140,0	M10x1	-	-	F319	EX319G2	-	156,00	122,00	22,8		
134,5	-	M10x1	-	-	F320	UC320G2	-	171,60	140,00	25,8		
-	146,0	M10x1	-	-	F320	EX320G2	-	171,60	140,00	27,6		
-	145,0	M10x1	-	-	F322	UK322G2H	-	205,00	178,00	42,6		
140,5	-	M10x1	-	-	F321	UC321G2	-	182,00	155,00	30,2	105	
149,0	-	M10x1	-	-	F322	UC322G2	-	205,00	178,00	39,3	110	
-	155,0	M10x1	-	-	F324	UK324G2H	-	228,00	208,00	51,9		
-	165,0	M10x1	-	-	F326	UK326G2H	-	252,00	242,00	68,5	115	
163,0	-	M10x1	-	-	F324	UC324G2	-	228,00	208,00	49,2	120	
-	180,0	M10x1	-	-	F328	UK328G2H	-	275,00	272,00	90,7	125	
177,0	-	M10x1	-	-	F326	UC326G2	-	252,00	242,00	63,6	130	
190,0	-	M10x1	-	-	F328	UC328G2	-	275,00	272,00	84,7	140	

→ Four-bolt piloted flange unit

FCE200

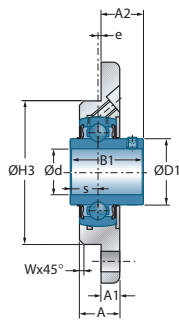
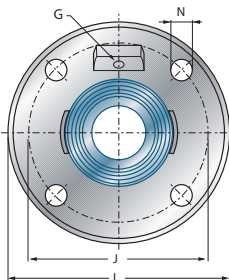
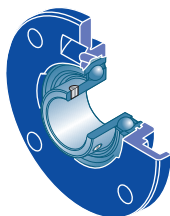

UCFCE200

Shaft diameter		Unit		Main dimensions [mm]									
d mm		L	J	A	A1	A2	W	H3 h8	e	N	s1	B	B1
12	UCFCE201	100	78	18,0	8,0	16,3	2	62	2,0	9,0	-	-	31,0
	USFCE201	100	78	18,0	8,0	14,0	2	62	2,0	9,0	-	-	22,0
	ESFCE201	100	78	18,0	8,0	20,1	2	62	2,0	9,0	-	-	28,6
	EXFCE201	100	78	18,0	8,0	24,5	2	62	2,0	9,0	-	-	43,5
15	UCFCE202	100	78	18,0	8,0	16,3	2	62	2,0	9,0	-	-	31,0
	USFCE202	100	78	18,0	8,0	14,0	2	62	2,0	9,0	-	-	22,0
	ESFCE202	100	78	18,0	8,0	20,1	2	62	2,0	9,0	-	-	28,6
	EXFCE202	100	78	18,0	8,0	24,5	2	62	2,0	9,0	-	-	43,5
17	UCFCE203	100	78	18,0	8,0	16,3	2	62	2,0	9,0	-	-	31,0
	USFCE203	100	78	18,0	8,0	14,0	2	62	2,0	9,0	-	-	22,0
	ESFCE203	100	78	18,0	8,0	20,1	2	62	2,0	9,0	-	-	28,6
	EXFCE203	100	78	18,0	8,0	24,5	2	62	2,0	9,0	-	-	43,5
20	UCFCE204	100	78	18,0	8,0	16,3	2	62	2,0	9,0	-	-	31,0
	USFCE204	100	78	18,0	8,0	16,0	2	62	2,0	9,0	-	-	25,0
	ESFCE204	100	78	18,0	8,0	21,4	2	62	2,0	9,0	-	-	30,9
	EXFCE204	100	78	18,0	8,0	24,5	2	62	2,0	9,0	-	-	43,5
	UKFCE205H	115	90	20,0	9,0	21,0	2	70	2,5	9,0	18,5	35,0	-
25	UCFCE205	115	90	20,0	9,0	17,2	2	70	2,5	9,0	-	-	34,0
	USFCE205	115	90	20,0	9,0	17,0	2	70	2,5	9,0	-	-	27,0
	ESFCE205	115	90	20,0	9,0	20,9	2	70	2,5	9,0	-	-	30,9
	EXFCE205	115	90	20,0	9,0	24,4	2	70	2,5	9,0	-	-	44,3
	UKFCE206H	125	100	21,0	9,5	22,5	2	80	2,0	11,5	20,5	38,0	-
30	UCFCE206	125	100	21,0	9,5	20,2	2	80	2,0	11,5	-	-	38,1
	USFCE206	125	100	21,0	9,5	20,0	2	80	2,0	11,5	-	-	30,0
	ESFCE206	125	100	21,0	9,5	24,7	2	80	2,0	11,5	-	-	35,7
	EXFCE206	125	100	21,0	9,5	28,1	2	80	2,0	11,5	-	-	48,3
	UKFCE207H	135	110	21,0	10,0	23,5	2	90	1,0	11,5	22,5	43,0	-
35	UCFCE207	135	110	21,0	10,0	24,4	2	90	1,0	11,5	-	-	42,9
	USFCE207	135	110	21,0	10,0	22,5	2	90	1,0	11,5	-	-	32,0
	ESFCE207	135	110	21,0	10,0	28,4	2	90	1,0	11,5	-	-	38,9
	EXFCE207	135	110	21,0	10,0	31,3	2	90	1,0	11,5	-	-	51,1
	UKFCE208H	145	120	23,0	11,5	25,5	2	100	1,0	11,5	24,5	46,0	-

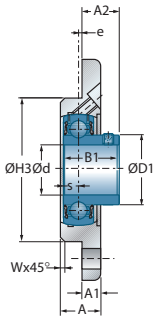

USFCE200

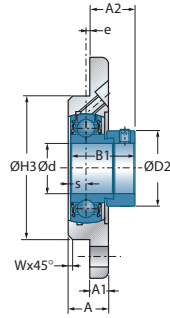

ESFCE200

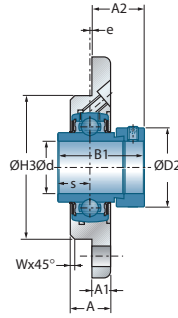

EXFCE200

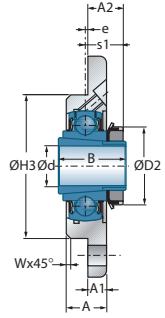

UKFCE200H

Main dimensions [mm]

Main dimensions [mm]				Housing	Bearing insert	Dynamic load rating	Static load rating	Weight	Shaft diameter
s	D1	D2	G			C_r [kN]	C_{0r} [kN]	kg	d mm
12,7	29,0	-	M6x1	FCE204	UC201G2	12,80	6,65	0,6	12
6,0	24,6	-	M6x1	FCE203	US201G2	9,55	4,78	0,5	
6,5	-	28,6	M6x1	FCE203	ES201G2	9,55	4,78	0,5	
17,0	-	33,3	M6x1	FCE204	EX201G2	12,80	6,65	0,7	
12,7	29,0	-	M6x1	FCE204	UC202G2	12,80	6,65	0,6	15
6,0	24,6	-	M6x1	FCE203	US202G2	9,55	4,78	0,5	
6,5	-	28,6	M6x1	FCE203	ES202G2	9,55	4,78	0,5	
17,0	-	33,3	M6x1	FCE204	EX202G2	12,80	6,65	0,6	
12,7	29,0	-	M6x1	FCE204	UC203G2	12,80	6,65	0,6	17
6,0	24,6	-	M6x1	FCE203	US203G2	9,55	4,78	0,5	
6,5	-	28,6	M6x1	FCE203	ES203G2	9,55	4,78	0,5	
17,0	-	33,3	M6x1	FCE204	EX203G2	12,80	6,65	0,6	
12,7	29,0	-	M6x1	FCE204	UC204G2	12,80	6,65	0,5	20
7,0	29,0	-	M6x1	FCE204	US204G2	12,80	6,65	0,5	
7,5	-	33,3	M6x1	FCE204	ES204G2	12,80	6,65	0,5	
17,0	-	33,3	M6x1	FCE204	EX204G2	12,80	6,65	0,6	
-	-	38,0	M6x1	FCE205	UK205G2H	14,00	7,88	0,8	
14,3	34,0	-	M6x1	FCE205	UC205G2	14,00	7,88	0,8	25
7,5	34,0	-	M6x1	FCE205	US205G2	14,00	7,88	0,8	
7,5	-	38,1	M6x1	FCE205	ES205G2	14,00	7,88	0,8	
17,4	-	38,1	M6x1	FCE205	EX205G2	14,00	7,88	0,8	
-	-	45,0	M6x1	FCE206	UK206G2H	19,50	11,20	1,0	
15,9	40,3	-	M6x1	FCE206	UC206G2	19,50	11,20	1,0	30
8,0	40,3	-	M6x1	FCE206	US206G2	19,50	11,20	0,9	
9,0	-	44,5	M6x1	FCE206	ES206G2	19,50	11,20	1,0	
18,2	-	44,5	M6x1	FCE206	EX206G2	19,50	11,20	1,1	
-	-	52,0	M6x1	FCE207	UK207G2H	25,70	15,20	1,3	
17,5	48,0	-	M6x1	FCE207	UC207G2	25,70	15,20	1,2	35
8,5	48,0	-	M6x1	FCE207	US207G2	25,70	15,20	1,2	
9,5	-	55,6	M6x1	FCE207	ES207G2	25,70	15,20	1,3	
18,8	-	55,6	M6x1	FCE207	EX207G2	25,70	15,20	1,4	
-	-	58,0	M6x1	FCE208	UK208G2H	29,60	18,20	1,7	



→ Four-bolt piloted flange unit

FCE200

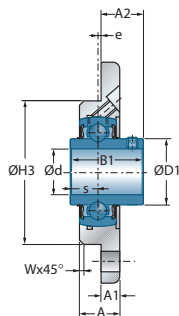
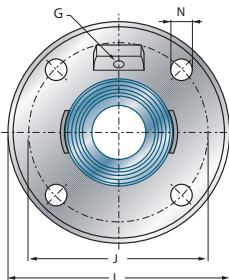
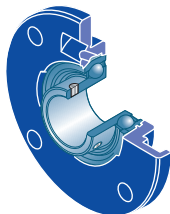

UCFCE200

Shaft diameter		Unit		Main dimensions [mm]									
d mm		L	J	A	A1	A2	W	H3 h8	e	N	s1	B	B1
40	UCFCE208	145	120	23,0	11,5	29,2	2	100	1,0	11,5	-	-	49,2
	USFCE208	145	120	23,0	11,5	24,0	2	100	1,0	11,5	-	-	34,0
	ESFCE208	145	120	23,0	11,5	31,7	2	100	1,0	11,5	-	-	43,7
	EXFCE208	145	120	23,0	11,5	33,9	2	100	1,0	11,5	-	-	56,3
	UKFCE209H	155	130	25,0	12,0	28,0	2	105	2,0	14,0	26,0	50,0	-
45	UCFCE209	155	130	25,0	12,0	28,2	2	105	2,0	14,0	-	-	49,2
	USFCE209	155	130	25,0	12,0	29,0	2	105	2,0	14,0	-	-	41,2
	ESFCE209	155	130	25,0	12,0	30,7	2	105	2,0	14,0	-	-	43,7
	EXFCE209	155	130	25,0	12,0	32,9	2	105	2,0	14,0	-	-	56,3
	UKFCE210H	165	135	25,5	13,0	28,5	3	110	1,0	14,0	27,5	55,0	-
50	UCFCE210	165	135	25,5	13,0	31,6	3	110	1,0	14,0	-	-	51,6
	USFCE210	165	135	25,5	13,0	31,6	3	110	1,0	14,0	-	-	43,5
	ESFCE210	165	135	25,5	13,0	31,7	3	110	1,0	14,0	-	-	43,7
	EXFCE210	165	135	25,5	13,0	37,1	3	110	1,0	14,0	-	-	62,7
	UKFCE211H	185	150	27,5	15,0	29,0	3	125	0,0	18,0	29,0	59,0	-
55	UCFCE211	185	150	27,5	15,0	33,4	3	125	0,0	18,0	-	-	55,6
	USFCE211	185	150	27,5	15,0	33,5	3	125	0,0	18,0	-	-	45,3
	ESFCE211	185	150	27,5	15,0	36,4	3	125	0,0	18,0	-	-	48,4
	EXFCE211	185	150	27,5	15,0	43,6	3	125	0,0	18,0	-	-	71,3
	UKFCE212H	195	160	30,5	16,0	32,0	3	135	1,0	18,0	31,0	62,0	-
60	UCFCE212	195	160	30,5	16,0	38,7	3	135	1,0	18,0	-	-	65,1
	USFCE212	195	160	30,5	16,0	37,8	3	135	1,0	18,0	-	-	53,7
	ESFCE212	195	160	30,5	16,0	36,3	3	135	1,0	18,0	-	-	49,3
	EXFCE212	195	160	30,5	16,0	45,8	3	135	1,0	18,0	-	-	77,7
	UKFCE213H	215	177	33,0	18,0	32,0	6	150	0,0	18,0	32,0	65,0	-
65	UCFCE213	215	177	33,0	18,0	39,7	6	150	0,0	18,0	-	-	65,1
	EXFCE213	215	177	33,0	18,0	51,6	6	150	0,0	18,0	-	-	85,7
	UKFCE215H	215	177	33,0	18,0	35,5	6	150	0,0	18,0	35,5	73,0	-
70	UCFCE214	215	177	33,0	18,0	44,4	6	150	0,0	18,0	-	-	74,6
	EXFCE214	215	177	33,0	18,0	51,6	6	150	0,0	18,0	-	-	85,7
	UKFCE216H	220	184	33,0	18,5	37,0	6	160	-2,0	18,0	39,0	78,0	-

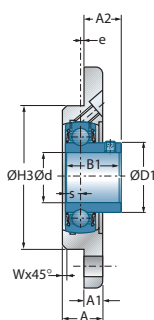

USFCE200

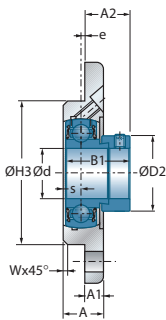

ESFCE200

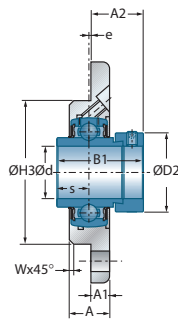

EXFCE200

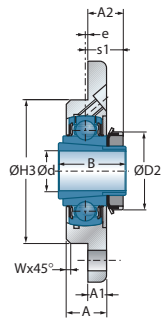

UKFCE200H

Main dimensions [mm]

Main dimensions [mm]				Housing	Bearing insert	Dynamic load rating	Static load rating	Weight	Shaft diameter
s	D1	D2	G			C_r [kN]	C_{Or} [kN]	kg	d mm
19,0	53,0	-	M6x1	FCE208	UC208G2	29,60	18,20	1,6	40
9,0	53,0	-	M6x1	FCE208	US208G2	29,60	18,20	1,6	
11,0	-	60,3	M6x1	FCE208	ES208G2	29,60	18,20	1,7	
21,4	-	60,3	M6x1	FCE208	EX208G2	29,60	18,20	1,8	
-	-	65,0	M6x1	FCE209	UK209G2H	31,85	20,80	2,0	
19,0	57,2	-	M6x1	FCE209	UC209G2	31,85	20,80	1,9	45
10,2	57,2	-	M6x1	FCE209	US209G2	31,85	20,80	1,8	
11,0	-	63,5	M6x1	FCE209	ES209G2	31,85	20,80	1,9	
21,4	-	63,5	M6x1	FCE209	EX209G2	31,85	20,80	2,1	
-	-	70,0	M8x1	FCE210	UK210G2H	35,10	23,20	2,4	
19,0	61,8	-	M8x1	FCE210	UC210G2	35,10	23,20	2,2	50
10,9	61,8	-	M8x1	FCE210	US210G2	35,10	23,20	2,2	
11,0	-	69,9	M8x1	FCE210	ES210G2	35,10	23,20	2,2	
24,6	-	69,9	M8x1	FCE210	EX210G2	35,10	23,20	2,4	
-	-	75,0	M6x1	FCE211	UK211G2H	43,55	29,20	3,2	
22,2	69,0	-	M6x1	FCE211	UC211G2	43,55	29,20	3,1	55
11,8	69,0	-	M6x1	FCE211	US211G2	43,55	29,20	3,1	
12,0	-	76,2	M6x1	FCE211	ES211G2	43,55	29,20	2,9	
27,7	-	76,2	M6x1	FCE211	EX211G2	43,55	29,20	3,4	
-	-	80,0	R1/8"	FCE212	UK212G2H	52,50	32,80	3,9	
25,4	74,9	-	R1/8"	FCE212	UC212G2	52,50	32,80	3,9	60
14,9	74,9	-	R1/8"	FCE212	US212G2	52,50	32,80	3,7	
12,0	-	84,2	R1/8"	FCE212	ES212G2	52,50	32,80	3,6	
30,9	-	84,2	R1/8"	FCE212	EX212G2	52,50	32,80	4,2	
-	-	85,0	R1/8"	FCE213	UK213G2H	57,20	40,00	5,0	
25,4	82,0	-	R1/8"	FCE213	UC213G2	57,20	40,00	4,9	65
34,1	-	86,0	R1/8"	FCE213	EX213G2	57,20	40,00	5,5	
-	-	98,0	R1/8"	FCE215	UK215G2H	66,00	49,50	5,8	
30,2	86,5	-	R1/8"	FCE214	UC214G2	62,00	45,00	5,1	70
34,1	-	96,8	R1/8"	FCE214	EX214G2	62,00	45,00	5,6	
-	-	105,0	R1/8"	FCE216	UK216G2H	72,50	54,20	6,1	



→ Four-bolt piloted flange unit

FCE200

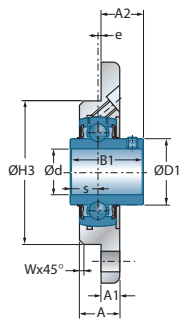
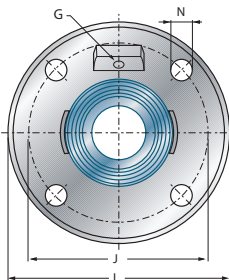
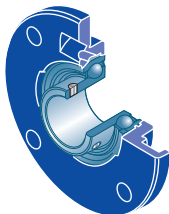

UCFCE200

Shaft diameter		Unit		Main dimensions [mm]									
d mm		L	J	A	A1	A2	W	H3 h8	e	N	s1	B	B1
75	UCFCE215	220	184	33,0	18,0	44,5	6	160	0,0	18,0	-	-	77,8
	EXFCE215	220	184	33,0	18,0	54,8	6	160	0,0	18,0	-	-	92,1
80	UCFCE216	220	184	33,0	18,5	51,3	6	160	-2,0	18,0	-	-	82,6
	EXFCE216	220	184	33,0	18,5	59,9	6	160	-2,0	18,0	-	-	95,2
	UKFCE218H	265	220	37,0	22,5	38,0	3	190	-4,0	23,0	42,0	86,0	-
90	UCFCE218	265	220	37,0	22,5	60,3	3	190	-4,0	23,0	-	-	96,0
	EXFCE218	265	220	37,0	22,5	50,5	3	190	-4,0	23,0	-	-	72,5

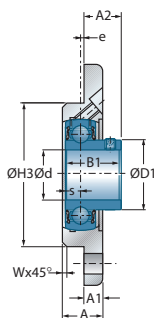

USFCE200

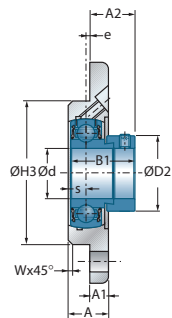

ESFCE200

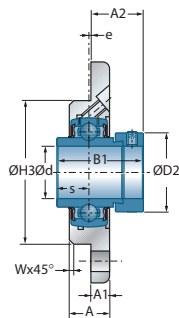

EXFCE200

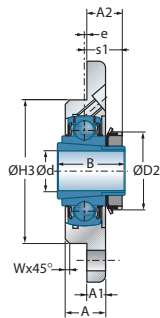

UKFCE200H

Main dimensions [mm]

Main dimensions [mm]				Housing	Bearing insert	Dynamic load rating	Static load rating	Weight	Shaft diameter
s	D1	D2	G			C_r [kN]	C_{0r} [kN]	kg	d mm
33,3	91,5	-	R1/8"	FCE215	UC215G2	66,00	49,50	5,5	75
37,3	-	102,0	R1/8"	FCE215	EX215G2	66,00	49,50	6,1	
33,3	98,0	-	R1/8"	FCE216	UC216G2	72,50	54,20	5,6	80
37,3	-	110,0	R1/8"	FCE216	EX216G2	72,50	54,20	5,9	
-	-	120,0	R1/8"	FCE218	UK218G2H	96,00	71,50	9,8	
39,7	111,0	-	R1/8"	FCE218	UC218G2	96,00	71,50	9,6	90
24,5	-	120,0	R1/8"	FCE218	EX218G2	96,00	71,50	10,0	





Self-aligning bearing units with cast iron or pressed steel housing

→ Four-bolt piloted flange unit

FC200

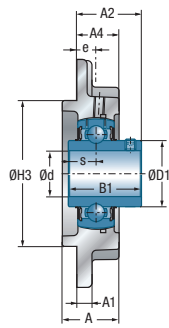
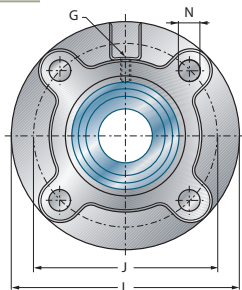
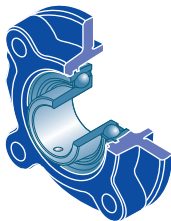

UCFC200

Shaft diameter		Unit		Main dimensions [mm]										
d mm		L	J	A	A1	A2	A4	H3 h8	e	N	s1	B	B1	s
12	UCFC201	100	78	25,5	6	28,3	20,5	62	10	12	-	-	31,0	12,7
	USFC201	90	70	23,0	5	26,0	19,0	55	10	12	-	-	22,0	6,0
	ESFC201	90	70	23,0	5	32,1	19,0	55	10	12	-	-	28,6	6,5
	EXFC201	100	78	25,5	6	36,5	20,5	62	10	12	-	-	43,5	17,0
15	UCFC202	100	78	25,5	6	28,3	20,5	62	10	12	-	-	31,0	12,7
	USFC202	90	70	23,0	5	26,0	19,0	55	10	12	-	-	22,0	6,0
	ESFC202	90	70	23,0	5	32,1	19,0	55	10	12	-	-	28,6	6,5
	EXFC202	100	78	25,5	6	36,5	20,5	62	10	12	-	-	43,5	17,0
17	UCFC203	100	78	25,5	6	28,3	20,5	62	10	12	-	-	31,0	12,7
	USFC203	90	70	23,0	5	26,0	19,0	55	10	12	-	-	22,0	6,0
	ESFC203	90	70	23,0	5	32,1	19,0	55	10	12	-	-	28,6	6,5
	EXFC203	100	78	25,5	6	36,5	20,5	62	10	12	-	-	43,5	17,0
20	UCFC204	100	78	25,5	6	28,3	20,5	62	10	12	-	-	31,0	12,7
	USFC204	100	78	25,5	6	28,0	20,5	62	10	12	-	-	25,0	7,0
	ESFC204	100	78	25,5	6	33,4	20,5	62	10	12	-	-	30,9	7,5
	EXFC204	100	78	25,5	6	36,5	20,5	62	10	12	-	-	43,5	17,0
	UKFC205H	115	90	27,0	7	28,5	21,0	70	10	12	18,5	35,0	-	-
25	UCFC205	115	90	27,0	7	29,7	21,0	70	10	12	-	-	34,0	14,3
	USFC205	115	90	27,0	7	29,5	21,0	70	10	12	-	-	27,0	7,5
	ESFC205	115	90	27,0	7	33,4	21,0	70	10	12	-	-	30,9	7,5
	EXFC205	115	90	27,0	7	36,9	21,0	70	10	12	-	-	44,3	17,4
	UKFC206H	125	100	31,0	8	30,5	23,0	80	10	12	20,5	38,0	-	-
30	UCFC206	125	100	31,0	8	32,2	23,0	80	10	12	-	-	38,1	15,9
	USFC206	125	100	31,0	8	32,0	23,0	80	10	12	-	-	30,0	8,0
	ESFC206	125	100	31,0	8	36,7	23,0	80	10	12	-	-	35,7	9,0
	EXFC206	125	100	31,0	8	40,1	23,0	80	10	12	-	-	48,3	18,2
	UKFC207H	135	110	34,0	9	33,5	26,0	90	11	14	22,5	43,0	-	-
35	UCFC207	135	110	34,0	9	36,4	26,0	90	11	14	-	-	42,9	17,5
	USFC207	135	110	34,0	9	34,5	26,0	90	11	14	-	-	32,0	8,5
	ESFC207	135	110	34,0	9	40,4	26,0	90	11	14	-	-	38,9	9,5
	EXFC207	135	110	34,0	9	43,3	26,0	90	11	14	-	-	51,1	18,8
	UKFC208H	145	120	36,0	9	35,5	26,0	100	11	14	24,5	46,0	-	-

* = equipped with one open protective cap for passing shafts; suffix CO or COE
 ** = equipped with one closed protective cap for shaft ends; suffix CC or CCE

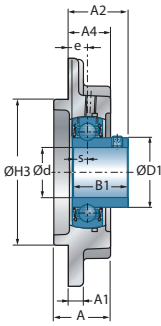

USFC200

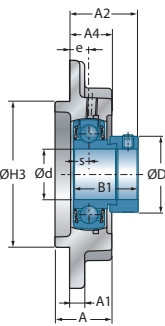

ESFC200

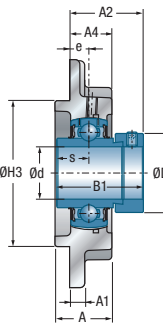

EXFC200

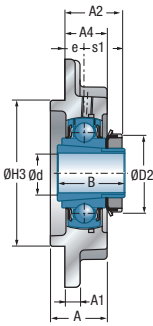

UKFC200H

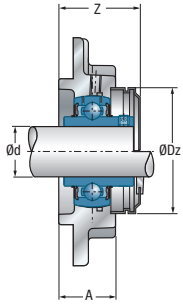

UCFC200CO(CC)

Main dimensions [mm]

Main dimensions [mm]					Housing	Bearing insert	Open protective cap*	Closed protective cap**	Dynamic load rating	Static load rating	Weight	Shaft diameter
D1	D2	G	Z	Dz					C_r [kN]	C_{Or} [kN]	kg	d mm
29,0	-	M6x1	36,5	54,0	FC204	UC201G2	CO	CC	12,80	6,65	0,7	12
24,6	-	M6x1	34,0	46,0	FC203	US201G2	CO	CC	9,55	4,78	0,5	
-	28,6	M6x1	40,7	46,0	FC203	ES201G2	COE	CCE	9,55	4,78	0,5	
-	33,3	M6x1	45,7	54,0	FC204	EX201G2	COE	CCE	12,80	6,65	0,8	
29,0	-	M6x1	36,5	54,0	FC204	UC202G2	CO	CC	12,80	6,65	0,7	15
24,6	-	M6x1	34,0	46,0	FC203	US202G2	CO	CC	9,55	4,78	0,5	
-	28,6	M6x1	40,7	46,0	FC203	ES202G2	COE	CCE	9,55	4,78	0,5	
-	33,3	M6x1	45,7	54,0	FC204	EX202G2	COE	CCE	12,80	6,65	0,7	
29,0	-	M6x1	36,5	54,0	FC204	UC203G2	CO	CC	12,80	6,65	0,6	17
24,6	-	M6x1	34,0	46,0	FC203	US203G2	CO	CC	9,55	4,78	0,5	
-	28,6	M6x1	40,7	46,0	FC203	ES203G2	COE	CCE	9,55	4,78	0,5	
-	33,3	M6x1	45,7	54,0	FC204	EX203G2	COE	CCE	12,80	6,65	0,7	
29,0	-	M6x1	36,5	54,0	FC204	UC204G2	CO	CC	12,80	6,65	0,6	20
29,0	-	M6x1	36,5	54,0	FC204	US204G2	CO	CC	12,80	6,65	0,6	
-	33,3	M6x1	45,7	54,0	FC204	ES204G2	COE	CCE	12,80	6,65	0,6	
-	33,3	M6x1	45,7	54,0	FC204	EX204G2	COE	CCE	12,80	6,65	0,7	
-	38,0	M6x1	39,1	60,0	FC205	UK205G2H	CO	CC	14,00	7,88	1,0	
34,0	-	M6x1	39,1	60,0	FC205	UC205G2	CO	CC	14,00	7,88	1,0	25
34,0	-	M6x1	39,1	60,0	FC205	US205G2	CO	CC	14,00	7,88	0,9	
-	38,1	M6x1	47,7	60,0	FC205	ES205G2	COE	CCE	14,00	7,88	0,9	
-	38,1	M6x1	47,7	60,0	FC205	EX205G2	COE	CCE	14,00	7,88	1,0	
-	45,0	M6x1	44,1	70,0	FC206	UK206G2H	CO	CC	19,50	11,20	1,3	
40,3	-	M6x1	44,1	70,0	FC206	UC206G2	CO	CC	19,50	11,20	1,3	30
40,3	-	M6x1	44,1	70,0	FC206	US206G2	CO	CC	19,50	11,20	1,2	
-	44,5	M6x1	53,2	70,0	FC206	ES206G2	COE	CCE	19,50	11,20	1,3	
-	44,5	M6x1	53,2	70,0	FC206	EX206G2	COE	CCE	19,50	11,20	1,4	
-	52,0	M6x1	48,8	80,0	FC207	UK207G2H	CO	CC	25,70	15,20	1,7	
48,0	-	M6x1	48,8	80,0	FC207	UC207G2	CO	CC	25,70	15,20	1,7	35
48,0	-	M6x1	48,8	80,0	FC207	US207G2	CO	CC	25,70	15,20	1,6	
-	55,6	M6x1	58,1	80,0	FC207	ES207G2	COE	CCE	25,70	15,20	1,7	
-	55,6	M6x1	58,1	80,0	FC207	EX207G2	COE	CCE	25,70	15,20	1,8	
-	58,0	M6x1	55,1	88,0	FC208	UK208G2H	CO	CC	29,60	18,20	2,1	



→ Four-bolt piloted flange unit

FC200

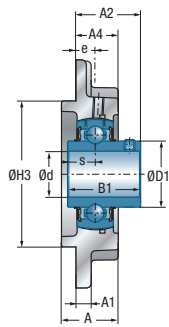
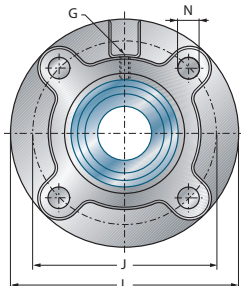
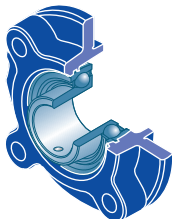

UCFC200

Shaft diameter		Unit		Main dimensions [mm]											
d mm		L	J	A	A1	A2	A4	H3 h8	e	N	s1	B	B1	s	
40	UCFC208	145	120	36,0	9	41,2	26,0	100	11	14	-	-	49,2	19,0	
	USFC208	145	120	36,0	9	36,0	26,0	100	11	14	-	-	34,0	9,0	
	ESFC208	145	120	36,0	9	43,7	26,0	100	11	14	-	-	43,7	11,0	
	EXFC208	145	120	36,0	9	45,9	26,0	100	11	14	-	-	56,3	21,4	
	UKFC209H	160	132	38,0	10	36,0	26,0	105	10	16	26,0	50,0	-	-	
45	UCFC209	160	132	38,0	10	40,2	26,0	105	10	16	-	-	49,2	19,0	
	USFC209	160	132	38,0	10	41,0	26,0	105	10	16	-	-	41,2	10,2	
	ESFC209	160	132	38,0	10	42,7	26,0	105	10	16	-	-	43,7	11,0	
	EXFC209	160	132	38,0	10	44,9	26,0	105	10	16	-	-	56,3	21,4	
	UKFC210H	165	138	40,0	14	37,5	28,0	110	10	16	27,5	55,0	-	-	
50	UCFC210	165	138	40,0	14	42,6	28,0	110	10	16	-	-	51,6	19,0	
	USFC210	165	138	40,0	14	42,6	28,0	110	10	16	-	-	43,5	10,9	
	ESFC210	165	138	40,0	14	42,7	28,0	110	10	16	-	-	43,7	11,0	
	EXFC210	165	138	40,0	14	48,1	28,0	110	10	16	-	-	62,7	24,6	
	UKFC211H	185	150	42,0	13	42,0	30,0	125	13	19	29,0	59,0	-	-	
55	UCFC211	185	150	42,0	13	46,4	30,0	125	13	19	-	-	55,6	22,2	
	USFC211	185	150	42,0	13	46,5	30,0	125	13	19	-	-	45,3	11,8	
	ESFC211	185	150	42,0	13	49,4	30,0	125	13	19	-	-	48,4	12,0	
	EXFC211	185	150	42,0	13	56,6	30,0	125	13	19	-	-	71,3	27,7	
	UKFC212H	195	160	48,0	15	48,0	36,0	135	17	19	31,0	62,0	-	-	
60	UCFC212	195	160	48,0	15	56,7	36,0	135	17	19	-	-	65,1	25,4	
	USFC212	195	160	48,0	15	55,8	36,0	135	17	19	-	-	53,7	14,9	
	ESFC212	195	160	48,0	15	54,3	36,0	135	17	19	-	-	49,3	12,0	
	EXFC212	195	160	48,0	15	63,8	36,0	135	17	19	-	-	77,7	30,9	
	UKFC213H	205	170	49,0	15	48,0	35,0	145	16	19	32,0	65,0	-	-	
65	UCFC213	205	170	49,0	15	55,7	35,0	145	16	19	-	-	65,1	25,4	
	EXFC213	205	170	49,0	15	67,6	35,0	145	16	19	-	-	85,7	34,1	
	UKFC215H	220	184	55,0	17	53,5	39,0	160	18	19	35,5	73,0	-	-	
70	UCFC214	215	177	52,0	16	61,4	38,0	150	17	19	-	-	74,6	30,2	
	EXFC214	215	177	52,0	16	68,6	38,0	150	17	19	-	-	85,7	34,1	
	UKFC216H	240	200	58,0	18	57,0	42,0	170	18	23	39,0	78,0	-	-	

* = equipped with one open protective cap for passing shafts; suffix CO or COE
 ** = equipped with one closed protective cap for shaft ends; suffix CC or CCE

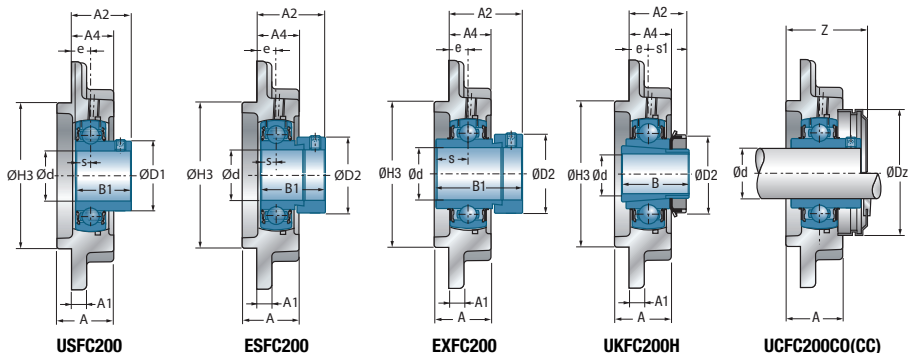

Main dimensions [mm]

Main dimensions [mm]					Housing	Bearing insert	Open protective cap*	Closed protective cap**	Dynamic load rating	Static load rating	Weight	Shaft diameter
D1	D2	G	Z	Dz				C _r [kN]	C _{0r} [kN]	kg	d mm	
53,0	-	M6x1	55,1	88,0	FC208	UC208G2	CO	CC	29,60	18,20	2,0	40
53,0	-	M6x1	55,1	88,0	FC208	US208G2	CO	CC	29,60	18,20	2,0	
-	60,3	M6x1	61,2	88,0	FC208	ES208G2	COE	CCE	29,60	18,20	2,0	
-	60,3	M6x1	61,2	88,0	FC208	EX208G2	COE	CCE	29,60	18,20	2,2	
-	65,0	M6x1	56,7	95,0	FC209	UK209G2H	CO	CC	31,85	20,80	2,6	
57,2	-	M6x1	56,7	95,0	FC209	UC209G2	CO	CC	31,85	20,80	2,5	45
57,2	-	M6x1	56,7	95,0	FC209	US209G2	CO	CC	31,85	20,80	2,4	
-	63,5	M6x1	63,8	95,0	FC209	ES209G2	COE	CCE	31,85	20,80	2,5	
-	63,5	M6x1	63,8	95,0	FC209	EX209G2	COE	CCE	31,85	20,80	2,7	
-	70,0	M6x1	59,8	100,0	FC210	UK210G2H	CO	CC	35,10	23,20	3,0	
61,8	-	M6x1	59,8	100,0	FC210	UC210G2	CO	CC	35,10	23,20	2,9	50
61,8	-	M6x1	59,8	100,0	FC210	US210G2	CO	CC	35,10	23,20	2,8	
-	69,9	M6x1	67,0	100,0	FC210	ES210G2	COE	CCE	35,10	23,20	2,9	
-	69,9	M6x1	67,0	100,0	FC210	EX210G2	COE	CCE	35,10	23,20	3,1	
-	75,0	M6x1	62,8	110,0	FC211	UK211G2H	CO	CC	43,55	29,20	3,9	
69,0	-	M6x1	62,8	110,0	FC211	UC211G2	CO	CC	43,55	29,20	3,9	55
69,0	-	M6x1	62,8	110,0	FC211	US211G2	CO	CC	43,55	29,20	3,8	
-	76,2	M6x1	76,2	110,0	FC211	ES211G2	COE	CCE	43,55	29,20	3,6	
-	76,2	M6x1	76,2	110,0	FC211	EX211G2	COE	CCE	43,55	29,20	4,1	
-	80,0	M6x1	73,2	120,0	FC212	UK212G2H	CO	CC	52,50	32,80	4,9	
74,9	-	M6x1	73,2	120,0	FC212	UC212G2	CO	CC	52,50	32,80	5,0	60
74,9	-	M6x1	73,2	120,0	FC212	US212G2	CO	CC	52,50	32,80	4,7	
-	84,2	M6x1	83,8	120,0	FC212	ES212G2	COE	CCE	52,50	32,80	4,6	
-	84,2	M6x1	83,8	120,0	FC212	EX212G2	COE	CCE	52,50	32,80	5,3	
-	85,0	M6x1	74,5	132,0	FC213	UK213G2H	CO	CC	57,20	40,00	5,6	
82,0	-	M6x1	74,5	132,0	FC213	UC213G2	CO	CC	57,20	40,00	5,5	65
-	86,0	M6x1	89,1	132,0	FC213	EX213G2	COE	CCE	57,20	40,00	6,1	
-	98,0	M10x1	-	-	FC215	UK215G2H	-	-	66,00	49,50	6,4	
86,5	-	M10x1	-	-	FC214	UC214G2	-	-	62,00	45,00	6,4	70
-	96,8	M10x1	-	-	FC214	EX214G2	-	-	62,00	45,00	6,9	
-	105,0	M10x1	-	-	FC216	UK216G2H	-	-	72,50	54,20	9,5	

→ Four-bolt piloted flange unit

FC200

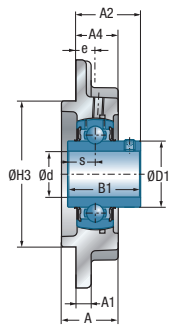
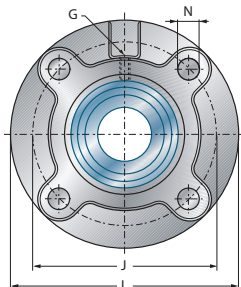
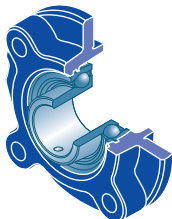

UCFC200

Shaft diameter		Unit		Main dimensions [mm]										
d mm		L	J	A	A1	A2	A4	H3 h8	e	N	s1	B	B1	s
75	UCFC215	220	184	55,0	17	62,5	39,0	160	18	19	-	-	77,8	33,3
	EXFC215	220	184	55,0	17	72,8	39,0	160	18	19	-	-	92,1	37,3
	UKFC217H	250	208	63,0	20	58,0	45,0	180	18	23	40,0	82,0	-	-
80	UCFC216	240	200	58,0	18	67,3	42,0	170	18	23	-	-	82,6	33,3
	EXFC216	240	200	58,0	18	75,9	42,0	170	18	23	-	-	95,2	37,3
	UKFC218H	265	220	68,0	20	64,0	50,0	190	22	23	42,0	86,0	-	-
85	UCFC217	250	208	63,0	20	69,6	45,0	180	18	23	-	-	85,7	34,1
	EXFC217	250	208	63,0	20	65,6	45,0	180	18	23	-	-	73,2	23,4
90	UCFC218	265	220	68,0	20	78,3	50,0	190	22	23	-	-	96,0	39,7
	EXFC218	265	220	68,0	20	68,5	50,0	190	22	23	-	-	72,5	24,5

* = equipped with one open protective cap for passing shafts: suffix CO or COE
 ** = equipped with one closed protective cap for shaft ends: suffix CC or CCE

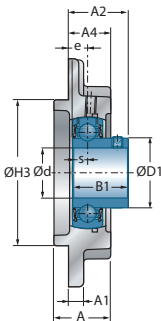

USFC200

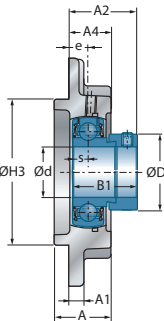

ESFC200

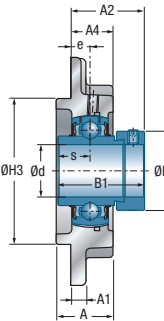

EXFC200

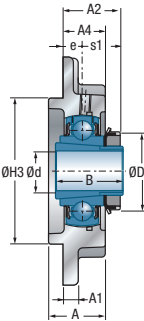

UKFC200H

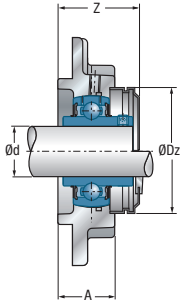

UCFC200CO(CC)

Main dimensions [mm]

					<i>Housing</i>	<i>Bearing insert</i>	<i>Open protective cap*</i>	<i>Closed protective cap**</i>	<i>Dynamic load rating</i>	<i>Static load rating</i>	<i>Weight</i>	<i>Shaft diameter</i>
D1	D2	G	Z	Dz					C_r [kN]	C_{Or} [kN]	kg	d mm
91,5	-	M10x1	-	-	FC215	UC215G2	-	-	66,00	49,50	7,2	75
-	102,0	M10x1	-	-	FC215	EX215G2	-	-	66,00	49,50	7,8	
-	110,0	M10x1	-	-	FC217	UK217G2H	-	-	83,20	63,80	11,1	
98,0	-	M10x1	-	-	FC216	UC216G2	-	-	72,50	54,20	9,0	80
-	110,0	M10x1	-	-	FC216	EX216G2	-	-	72,50	54,20	9,4	
-	120,0	M10x1	-	-	FC218	UK218G2H	-	-	96,00	71,50	13,4	
105,1	-	M10x1	-	-	FC217	UC217G2	-	-	83,20	63,80	10,6	85
-	119,0	M10x1	-	-	FC217	EX217G2	-	-	83,20	63,80	11,0	
111,0	-	M10x1	-	-	FC218	UC218G2	-	-	96,00	71,50	13,2	90
-	120,0	M10x1	-	-	FC218	EX218G2	-	-	96,00	71,50	13,6	



→ Four-bolt piloted flange unit

FEE200

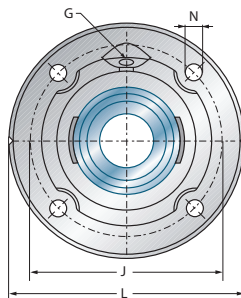

Shaft diameter		Unit		Main dimensions [mm]								
d mm		L	J	A	A1	A2	A4	H3 h8	e	N	B1	
25	USFEE205	115	92	23,5	9,0	29,0	20,5	75	9,5	9,0	27,0	
	ESFEE205	115	92	23,5	9,0	32,9	20,5	75	9,5	9,0	30,9	
30	USFEE206	127	105	27,0	9,5	32,5	24,0	85	10,5	9,0	30,0	
	ESFEE206	127	105	27,0	9,5	37,2	24,0	85	10,5	9,0	35,7	
35	USFEE207	135	110	28,0	10,0	32,5	24,0	90	9,0	11,5	32,0	
	ESFEE207	135	110	28,0	10,0	38,4	24,0	90	9,0	11,5	38,9	
40	USFEE208	145	120	31,0	11,5	36,5	27,0	100	11,5	11,5	34,0	
	ESFEE208	145	120	31,0	11,5	44,2	27,0	100	11,5	11,5	43,7	
45	USFEE209	155	130	31,5	12,0	42,5	27,5	105	11,5	14,0	41,2	
	ESFEE209	155	130	31,5	12,0	44,2	27,5	105	11,5	14,0	43,7	
50	USFEE210	165	136	32,5	13,0	45,1	28,5	115	12,5	14,0	43,5	
	ESFEE210	165	136	32,5	13,0	45,2	28,5	115	12,5	14,0	43,7	
60	USFEE212	195	165	40,5	16,0	55,8	36,5	140	17,0	14,0	53,7	
	ESFEE212	195	165	40,5	16,0	54,3	36,5	140	17,0	14,0	49,3	

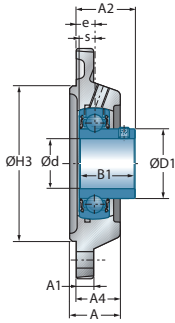

USFEE200

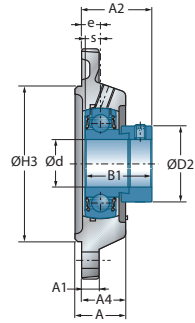

ESFEE200

Main dimensions [mm]				Housing	Bearing insert	Dynamic load rating	Static load rating	Weight	Shaft diameter
s	D1	D2	G			C_r [kN]	C_{0r} [kN]	kg	d mm
7,5	34,0	-	R1/8"	FEE205	US205G2	14,00	7,88	0,8	25
7,5	-	38,1	R1/8"	FEE205	ES205G2	14,00	7,88	0,8	
8,0	40,3	-	R1/8"	FEE206	US206G2	19,50	11,20	1,1	30
9,0	-	44,5	R1/8"	FEE206	ES206G2	19,50	11,20	1,2	
8,5	48,0	-	R1/8"	FEE207	US207G2	25,70	15,20	1,4	35
9,5	-	55,6	R1/8"	FEE207	ES207G2	25,70	15,20	1,5	
9,0	53,0	-	R1/8"	FEE208	US208G2	29,60	18,20	1,8	40
11,0	-	60,3	R1/8"	FEE208	ES208G2	29,60	18,20	1,9	
10,2	57,2	-	R1/8"	FEE209	US209G2	31,85	20,80	2,1	45
11,0	-	63,5	R1/8"	FEE209	ES209G2	31,85	20,80	2,1	
10,9	61,8	-	R1/8"	FEE210	US210G2	35,10	23,20	2,5	50
11,0	-	69,9	R1/8"	FEE210	ES210G2	35,10	23,20	2,5	
14,9	74,9	-	R1/8"	FEE212	US212G2	52,50	32,80	4,3	60
12,0	-	84,2	R1/8"	FEE212	ES212G2	52,50	32,80	4,2	



→ Four-bolt piloted flange unit - Square

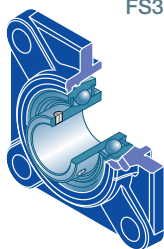

FS300

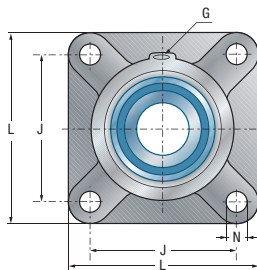

Shaft diameter		Unit		Main dimensions [mm]												
d mm		L	J	A	A1	A2	A4	H3 h8	e	N	s1	B	B1	s		
20	UKFS305H	110	80	29	13	30,5	22	80	9	16	21,5	35,0	-	-		
25	UCFS305	110	80	29	13	32,0	22	80	9	16	-	-	38,0	15,0		
	EXFS305	110	80	29	13	39,1	22	80	9	16	-	-	46,8	16,7		
	UKFS306H	125	95	32	15	33,0	24	90	10	16	23,0	38,0	-	-		
30	UCFS306	125	95	32	15	36,0	24	90	10	16	-	-	43,0	17,0		
	EXFS306	125	95	32	15	42,5	24	90	10	16	-	-	50,0	17,5		
	UKFS307H	135	100	36	16	36,5	27	100	11	19	25,5	43,0	-	-		
35	UCFS307	135	100	36	16	40,0	27	100	11	19	-	-	48,0	19,0		
	EXFS307	135	100	36	16	44,3	27	100	11	19	-	-	51,6	18,3		
	UKFS308H	150	112	40	17	40,5	30	115	13	19	27,5	46,0	-	-		
40	UCFS308	150	112	40	17	46,0	30	115	13	19	-	-	52,0	19,0		
	EXFS308	150	112	40	17	50,3	30	115	13	19	-	-	57,1	19,8		
	UKFS309H	160	125	44	18	44,0	33	125	14	19	30,0	50,0	-	-		
45	UCFS309	160	125	44	18	49,0	33	125	14	19	-	-	57,0	22,0		
	EXFS309	160	125	44	18	52,9	33	125	14	19	-	-	58,7	19,8		
	UKFS310H	175	132	48	19	48,0	36	140	16	23	32,0	55,0	-	-		
50	UCFS310	175	132	48	19	55,0	36	140	16	23	-	-	61,0	22,0		
	EXFS310	175	132	48	19	58,0	36	140	16	23	-	-	66,6	24,6		
	UKFS311H	185	140	52	20	51,0	39	150	17	23	34,0	59,0	-	-		
55	UCFS311	185	140	52	20	58,0	39	150	17	23	-	-	66,0	25,0		
	EXFS311	185	140	52	20	62,2	39	150	17	23	-	-	73,0	27,8		
	UKFS312H	195	150	56	22	55,5	42	160	19	23	36,5	62,0	-	-		
60	UCFS312	195	150	56	22	64,0	42	160	19	23	-	-	71,0	26,0		
	EXFS312	195	150	56	22	67,4	42	160	19	23	-	-	79,4	30,95		
	UKFS313H	208	166	58	22	53,5	40	175	15	23	38,5	65,0	-	-		
65	UCFS313	208	166	58	22	60,0	40	175	15	23	-	-	75,0	30,0		
	EXFS313	208	166	58	22	68,2	40	175	15	23	-	-	85,7	32,5		
	UKFS315H	236	184	66	25	63,5	48	200	21	25	42,5	73,0	-	-		
70	UCFS314	226	178	61	25	65,0	43	185	18	25	-	-	78,0	33,0		
	EXFS314	226	178	61	25	75,9	43	185	18	25	-	-	92,1	34,15		
	UKFS316H	250	196	68	27	62,5	48	210	18	31	44,5	78,0	-	-		

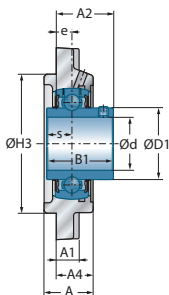

UCFS300

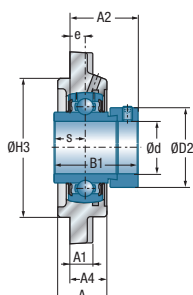

EXFS300

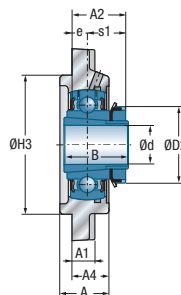

UKFS300H

Main dimensions [mm]

Main dimensions [mm]			Housing	Bearing insert	Dynamic load rating	Static load rating	Weight	Shaft diameter
D1	D2	G			C_r [kN]	C_{Or} [kN]	kg	d mm
35,4	38,0	M6x1	FS305	UK305G2H	22,36	11,50	1,4	20
35,4	-	M6x1	FS305	UC305G2	22,36	11,50	1,2	25
-	42,8	M6x1	FS305	EX305G2	22,36	11,50	1,3	
-	45,0	M6x1	FS306	UK306G2H	27,00	15,20	1,8	
44,6	-	M6x1	FS306	UC306G2	27,00	15,20	1,8	30
-	50,0	M6x1	FS306	EX306G2	27,00	15,20	1,9	
-	52,0	M6x1	FS307	UK307G2H	33,50	19,20	2,5	
48,9	-	M6x1	FS307	UC307G2	33,50	19,20	2,3	35
-	55,0	M6x1	FS307	EX307G2	33,50	19,20	2,4	
-	58,0	M6x1	FS308	UK308G2H	40,56	24,00	3,2	
56,5	-	M6x1	FS308	UC308G2	40,56	24,00	3,1	40
-	63,5	M6x1	FS308	EX308G2	40,56	24,00	3,2	
-	65,0	M6x1	FS309	UK309G2H	53,00	31,80	4,0	
61,8	-	M6x1	FS309	UC309G2	53,00	31,80	3,9	45
-	70,0	M6x1	FS309	EX309G2	53,00	31,80	4,0	
-	70,0	M6x1	FS310	UK310G2H	62,00	37,80	5,0	
68,7	-	M6x1	FS310	UC310G2	62,00	37,80	4,9	50
-	76,2	M6x1	FS310	EX310G2	62,00	37,80	5,1	
-	75,0	M6x1	FS311	UK311G2H	71,50	44,80	6,0	
74,9	-	M6x1	FS311	UC311G2	71,50	44,80	5,7	55
-	83,0	M6x1	FS311	EX311G2	71,50	44,80	6,1	
-	80,0	M6x1	FS312	UK312G2H	81,60	51,80	7,4	
81,0	-	M6x1	FS312	UC312G2	81,60	51,80	7,5	60
-	89,0	M6x1	FS312	EX312G2	81,60	51,80	7,8	
-	85,0	M6x1	FS313	UK313G2H	93,86	60,50	8,8	
87,5	-	M6x1	FS313	UC313G2	93,86	60,50	8,8	65
-	97,0	M6x1	FS313	EX313G2	93,86	60,50	9,2	
-	98,0	M10x1	FS315	UK315G2H	113,36	76,80	13,1	
94,0	-	M10x1	FS314	UC314G2	104,26	68,00	11,0	70
-	102,0	M10x1	FS314	EX314G2	104,26	68,00	11,5	
-	105,0	M10x1	FS316	UK316G2H	122,85	86,50	15,1	



→ Four-bolt piloted flange unit - Square

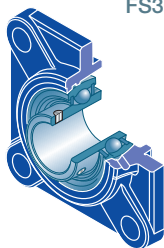

FS300

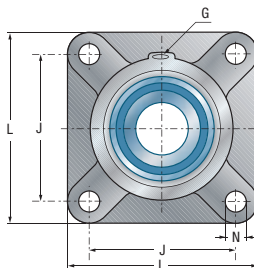

		Main dimensions [mm]												
d mm	Unit	L	J	A	A1	A2	A4	H3 h8	e	N	s1	B	B1	s
75	UCFS315	236	184	66	25	71,0	48	200	21	25	-	-	82,0	32,0
	EXFS315	236	184	66	25	83,7	48	200	21	25	-	-	100,0	37,3
	UKFS317H	260	204	74	27	72,0	54	220	24	31	48,0	82,0	-	-
80	UCFS316	250	196	68	27	70,0	48	210	18	31	-	-	86,0	34,0
	EXFS316	250	196	68	27	83,9	48	210	18	31	-	-	106,4	40,5
	UKFS318H	280	216	76	30	72,0	56	240	24	35	48,0	86,0	-	-
85	UCFS317	260	204	74	27	80,0	54	220	24	31	-	-	96,0	40,0
	EXFS317	260	204	74	27	91,5	54	220	24	31	-	-	109,5	42,0
	UKFS319H	290	228	94	30	91,0	74	250	39	35	52,0	90,0	-	-
90	UCFS318	280	216	76	30	80,0	56	240	24	35	-	-	96,0	40,0
	EXFS318	280	216	76	30	96,3	56	240	24	35	-	-	115,9	43,6
	UKFS320H	310	242	94	32	93,0	74	260	39	38	54,0	97,0	-	-
95	UCFS319	290	228	94	30	101,0	74	250	39	35	-	-	103,0	41,0
	EXFS319	290	228	94	30	114,5	74	250	39	35	-	-	122,3	46,8
100	UCFS320	310	242	94	32	105,0	74	260	39	38	-	-	108,0	42,0
	EXFS320	310	242	94	32	117,6	74	260	39	38	-	-	128,6	50,0
	UKFS322H	340	266	96	35	96,0	71	300	35	41	61,0	105,0	-	-
105	UCFS321	310	242	94	32	107,0	74	260	39	38	-	-	112,0	44,0
110	UCFS322	340	266	96	35	106,0	71	300	35	41	-	-	117,0	46,0
	UKFS324H	370	290	110	40	100,0	80	330	35	41	65,0	112,0	-	-
115	UKFS326H	410	320	115	45	104,0	85	360	35	41	69,0	121,0	-	-
120	UCFS324	370	290	110	40	110,0	80	330	35	41	-	-	126,0	51,0
125	UKFS328H	450	350	125	55	118,0	95	400	45	41	73,0	131,0	-	-
130	UCFS326	410	320	115	45	116,0	85	360	35	41	-	-	135,0	54,0
140	UCFS328	450	350	125	55	131,0	95	400	45	41	-	-	145,0	59,0

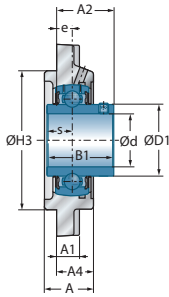

UCFS300

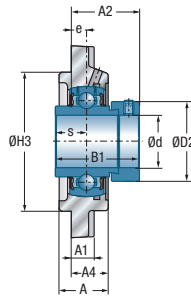

EXFS300

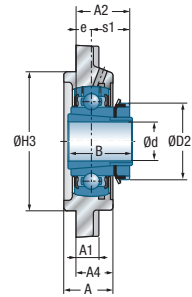

UKFS300H

Main dimensions [mm]

Housing

Bearing insert

Dynamic load rating

Static load rating

Weight

Shaft diameter

D1	D2	G			C_r [kN]	C_{Or} [kN]	kg	d mm
100,5	-	M10x1	FS315	UC315G2	113,36	76,80	12,4	75
-	113,0	M10x1	FS315	EX315G2	113,36	76,80	13,5	
-	110,0	M10x1	FS317	UK317G2H	132,60	96,50	17,3	
107,9	-	M10x1	FS316	UC316G2	122,85	86,50	14,9	80
-	119,0	M10x1	FS316	EX316G2	122,85	86,50	16,0	
-	120,0	M10x1	FS318	UK318G2H	143,00	108,00	21,3	
114,0	-	M10x1	FS317	UC317G2	132,60	96,50	17,3	85
-	127,0	M10x1	FS317	EX317G2	132,60	96,50	18,4	
-	125,0	M10x1	FS319	UK319G2H	156,00	122,00	25,2	
120,0	-	M10x1	FS318	UC318G2	143,00	108,00	21,2	90
-	133,0	M10x1	FS318	EX318G2	143,00	108,00	22,4	
134,5	130,0	M10x1	FS320	UK320G2H	171,60	140,00	29,1	
126,5	-	M10x1	FS319	UC319G2	156,00	122,00	24,9	95
-	140,0	M10x1	FS319	EX319G2	156,00	122,00	26,4	
134,5	-	M10x1	FS320	UC320G2	171,60	140,00	29,4	100
-	146,0	M10x1	FS320	EX320G2	171,60	140,00	31,2	
-	145,0	M10x1	FS322	UK322G2H	205,00	178,00	41,6	
140,5	-	M10x1	FS321	UC321G2	182,00	155,00	29,8	105
149,0	-	M10x1	FS322	UC322G2	205,00	178,00	38,3	110
-	155,0	M10x1	FS324	UK324G2H	228,00	208,00	54,4	
176,1	165,0	M10x1	FS326	UK326G2H	252,00	242,00	72,8	115
163,0	-	M10x1	FS324	UC324G2	228,00	208,00	51,7	120
-	180,0	M10x1	FS328	UK328G2H	275,00	272,00	98,7	125
177,0	-	M10x1	FS326	UC326G2	252,00	242,00	67,9	130
190,0	-	M10x1	FS328	UC328G2	275,00	272,00	92,8	140



→ Three-bolt flanged unit

FTE200

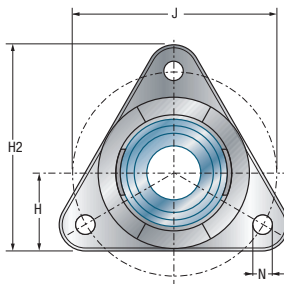
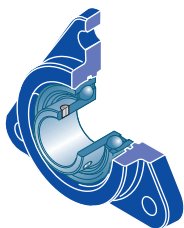

Shaft diameter		Unit		Main dimensions [mm]								
d mm		H	J	A	A1	A2	H2	e	N	B1	s	
12	USFTE201	31	76,1	20	11	26,0	81	10,0	11,5	22,0	6,0	
	ESFTE201	31	76,1	20	11	32,1	81	10,0	11,5	28,6	6,5	
15	USFTE202	31	76,1	20	11	26,0	81	10,0	11,5	22,0	6,0	
	ESFTE202	31	76,1	20	11	32,1	81	10,0	11,5	28,6	6,5	
17	USFTE203	31	76,1	20	11	26,0	81	10,0	11,5	22,0	6,0	
	ESFTE203	31	76,1	20	11	32,1	81	10,0	11,5	28,6	6,5	
20	USFTE204	35	89,5	20	11	29,0	92	11,0	11,5	25,0	7,0	
	ESFTE204	35	89,5	20	11	34,4	92	11,0	11,5	30,9	7,5	
25	USFTE205	36	96,0	22	12	32,1	97	12,6	11,0	27,0	7,5	
	ESFTE205	36	96,0	22	12	36,0	97	12,6	11,0	30,9	7,5	
30	USFTE206	44	116,0	24	12	35,0	117	13,0	11,0	30,0	8,0	
	ESFTE206	44	116,0	24	12	39,7	117	13,0	11,0	35,7	9,0	
35	USFTE207	48	129,7	27	16	39,1	128	15,6	13,5	32,0	8,5	
	ESFTE207	48	129,7	27	16	45,0	128	15,6	13,5	38,9	9,5	
40	USFTE208	51	140,0	30	16	43,8	137	18,8	13,5	34,0	9,0	
	ESFTE208	51	140,0	30	16	51,5	137	18,8	13,5	43,7	11,0	
45	USFTE209	55	160,0	33	16	50,2	150	19,2	14,0	41,2	10,2	
	ESFTE209	55	160,0	33	16	51,9	150	19,2	14,0	43,7	11,0	
50	USFTE210	55	160,0	33	16	51,8	150	19,2	14,0	43,5	10,9	
	ESFTE210	55	160,0	33	16	51,9	150	19,2	14,0	43,7	11,0	

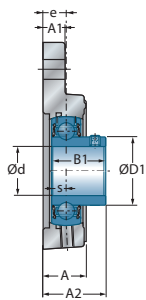

USFTE200

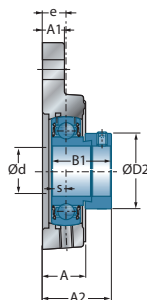

ESFTE200

Main dimensions [mm]			Housing	Bearing insert	Dynamic load rating	Static load rating	Weight	Shaft diameter
D1	D2	G			C_r [kN]	C_{0r} [kN]	kg	d mm
24,6	-	M6X1	FTE202	US201G2	9,55	4,78	0,4	12
-	28,6	M6X1	FTE202	ES201G2	9,55	4,78	0,4	
24,6	-	M6X1	FTE202	US202G2	9,55	4,78	0,4	15
-	28,6	M6X1	FTE202	ES202G2	9,55	4,78	0,4	
24,6	-	M6X1	FTE202	US203G2	9,55	4,78	0,4	17
-	28,6	M6X1	FTE202	ES203G2	9,55	4,78	0,4	
29,0	-	R1/8"	FTE204	US204G2	12,80	6,65	0,6	20
-	33,3	R1/8"	FTE204	ES204G2	12,80	6,65	0,6	
34,0	-	R1/8"	FTE205	US205G2	14,00	7,88	0,6	25
-	38,1	R1/8"	FTE205	ES205G2	14,00	7,88	0,6	
40,3	-	R1/8"	FTE206	US206G2	19,50	11,20	1,0	30
-	44,5	R1/8"	FTE206	ES206G2	19,50	11,20	1,1	
48,0	-	R1/8"	FTE207	US207G2	25,70	15,20	1,4	35
-	55,6	R1/8"	FTE207	ES207G2	25,70	15,20	1,5	
53,0	-	R1/8"	FTE208	US208G2	29,60	18,20	1,7	40
-	60,3	R1/8"	FTE208	ES208G2	29,60	18,20	1,7	
57,2	-	R1/8"	FTE209	US209G2	31,85	20,80	2,1	45
-	63,5	R1/8"	FTE209	ES209G2	31,85	20,80	2,1	
61,8	-	R1/8"	FTE210	US210G2	35,10	23,20	2,0	50
-	69,9	R1/8"	FTE210	ES210G2	35,10	23,20	2,1	



→ Two-bolt flanged unit

FLE200

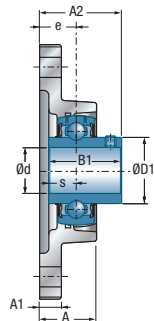
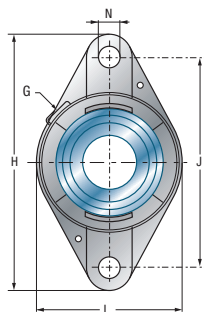

UCFLE200

Shaft diameter		Unit		Main dimensions [mm]										
d mm		L	H	J	A	A1	A2	e	N	s1	B	B1	s	
12	UCFLE201	61	112	90,0	30,3	10,0	37,3	19	11,5	-	-	31,0	12,7	
	USFLE201	57	99	76,5	26,0	9,5	33,0	17	11,5	-	-	22,0	6,0	
	ESFLE201	57	99	76,5	26,0	9,5	33,0	17	11,5	-	-	28,6	6,5	
	EXFLE201	61	112	90,0	30,3	10,0	37,3	19	11,5	-	-	43,5	17,0	
15	UCFLE202	61	112	90,0	30,3	10,0	37,3	19	11,5	-	-	31,0	12,7	
	USFLE202	57	99	76,5	26,0	9,5	33,0	17	11,5	-	-	22,0	6,0	
	ESFLE202	57	99	76,5	26,0	9,5	33,0	17	11,5	-	-	28,6	6,5	
	EXFLE202	61	112	90,0	30,3	10,0	37,3	19	11,5	-	-	43,5	17,0	
17	UCFLE203	61	112	90,0	30,3	10,0	37,3	19	11,5	-	-	31,0	12,7	
	USFLE203	61	112	90,0	30,3	10,0	35,0	19	11,5	-	-	22,0	6,0	
	ESFLE203	61	112	90,0	30,3	10,0	35,0	19	11,5	-	-	28,6	6,5	
	EXFLE203	61	112	90,0	30,3	10,0	37,3	19	11,5	-	-	43,5	17,0	
20	UCFLE204	61	112	90,0	30,3	10,0	37,3	19	11,5	-	-	31,0	12,7	
	USFLE204	61	112	90,0	30,3	10,0	37,0	19	11,5	-	-	25,0	7,0	
	ESFLE204	61	112	90,0	30,3	10,0	42,4	19	11,5	-	-	30,9	7,5	
	EXFLE204	61	112	90,0	30,3	10,0	45,5	19	11,5	-	-	43,5	17,0	
	UKFLE205H	70	124	99,0	29,3	11,0	37,5	19	11,5	18,5	35,0	-	-	
25	UCFLE205	70	124	99,0	29,3	11,0	38,7	19	11,5	-	-	34,0	14,3	
	USFLE205	70	124	99,0	29,3	11,0	38,5	19	11,5	-	-	27,0	7,5	
	ESFLE205	70	124	99,0	29,3	11,0	42,4	19	11,5	-	-	30,9	7,5	
	EXFLE205	70	124	99,0	29,3	11,0	45,9	19	11,5	-	-	44,3	17,4	
	UKFLE206H	80	142	116,5	32,1	12,0	40,5	20	11,5	20,5	38,0	-	-	
30	UCFLE206	80	142	116,5	32,1	12,0	42,2	20	11,5	-	-	38,1	15,9	
	USFLE206	80	142	116,5	32,1	12,0	42,0	20	11,5	-	-	30,0	8,0	
	ESFLE206	80	142	116,5	32,1	12,0	46,7	20	11,5	-	-	35,7	9,0	
	EXFLE206	80	142	116,5	32,1	12,0	50,1	20	11,5	-	-	48,3	18,2	
	UKFLE207H	92	155	130,0	33,7	12,5	43,5	21	14,0	22,5	43,0	-	-	
35	UCFLE207	92	155	130,0	33,7	12,5	46,4	21	14,0	-	-	42,9	17,5	
	USFLE207	92	155	130,0	33,7	12,5	44,5	21	14,0	-	-	32,0	8,5	
	ESFLE207	92	155	130,0	33,7	12,5	50,4	21	14,0	-	-	38,9	9,5	
	EXFLE207	92	155	130,0	33,7	12,5	53,3	21	14,0	-	-	51,1	18,8	
	UKFLE208H	105	172	143,5	37,5	13,0	48,5	24	14,0	24,5	46,0	-	-	

* = equipped with one open protective cap for passing shafts; suffix CO or COE
 ** = equipped with one closed protective cap for shaft ends; suffix CC or CCE

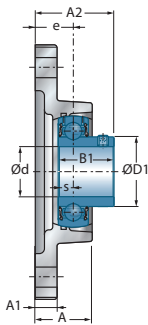

USFLE200

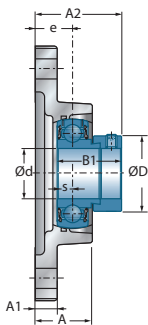

ESFLE200

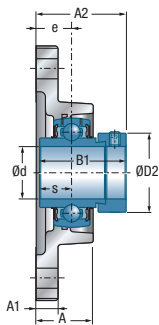

EXFLE200

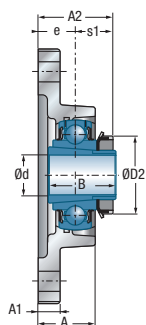

UKFLE200H

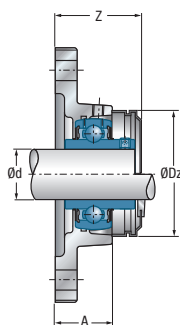

UCFLE200CO(CC)

Main dimensions [mm]

Main dimensions [mm]					Housing	Bearing insert	Open protective cap*	Closed protective cap**	Dynamic load rating	Static load rating	Weight	Shaft diameter
D1	D2	G	Z	Dz					C _r [kN]	C _{0r} [kN]	kg	d mm
29,0	-	R1/8"	41,8	54,0	FLE204	UC201G2	CO	CC	12,80	6,65	0,5	12
24,6	-	R1/8"	41,8	46,0	FLE203	US201G2	CO	CC	9,55	4,78	0,4	
-	28,6	R1/8"	48,5	46,0	FLE203	ES201G2	COE	CCE	9,55	4,78	0,4	
-	33,3	R1/8"	51,0	54,0	FLE204	EX201G2	COE	CCE	12,80	6,65	0,6	
29,0	-	R1/8"	41,8	54,0	FLE204	UC202G2	CO	CC	12,80	6,65	0,5	15
24,6	-	R1/8"	41,8	46,0	FLE203	US202G2	CO	CC	9,55	4,78	0,4	
-	28,6	R1/8"	48,5	46,0	FLE203	ES202G2	COE	CCE	9,55	4,78	0,4	
-	33,3	R1/8"	51,0	54,0	FLE204	EX202G2	COE	CCE	12,80	6,65	0,6	
29,0	-	R1/8"	41,8	54,0	FLE204	UC203G2	CO	CC	12,80	6,65	0,5	17
24,6	-	R1/8"	41,8	46,0	FLE203	US203G2	CO	CC	9,55	4,78	0,4	
-	28,6	R1/8"	48,5	46,0	FLE203	ES203G2	COE	CCE	9,55	4,78	0,4	
-	33,3	R1/8"	51,0	54,0	FLE204	EX203G2	COE	CCE	12,80	6,65	0,6	
29,0	-	R1/8"	41,8	54,0	FLE204	UC204G2	CO	CC	12,80	6,65	0,5	20
29,0	-	R1/8"	41,8	54,0	FLE204	US204G2	CO	CC	12,80	6,65	0,4	
-	33,3	R1/8"	51,0	54,0	FLE204	ES204G2	COE	CCE	12,80	6,65	0,5	
-	33,3	R1/8"	51,0	54,0	FLE204	EX204G2	COE	CCE	12,80	6,65	0,5	
-	38,0	R1/8"	43,9	60,0	FLE205	UK205G2H	CO	CC	14,00	7,88	0,6	
34,0	-	R1/8"	43,9	60,0	FLE205	UC205G2	CO	CC	14,00	7,88	0,6	25
34,0	-	R1/8"	43,9	60,0	FLE205	US205G2	CO	CC	14,00	7,88	0,6	
-	38,1	R1/8"	52,5	60,0	FLE205	ES205G2	COE	CCE	14,00	7,88	0,6	
-	38,1	R1/8"	52,5	60,0	FLE205	EX205G2	COE	CCE	14,00	7,88	0,7	
-	45,0	R1/8"	46,9	70,0	FLE206	UK206G2H	CO	CC	19,50	11,20	0,9	
40,3	-	R1/8"	46,9	70,0	FLE206	UC206G2	CO	CC	19,50	11,20	0,8	30
40,3	-	R1/8"	46,9	70,0	FLE206	US206G2	CO	CC	19,50	11,20	0,8	
-	44,5	R1/8"	56,0	70,0	FLE206	ES206G2	COE	CCE	19,50	11,20	0,9	
-	44,5	R1/8"	56,0	70,0	FLE206	EX206G2	COE	CCE	19,50	11,20	0,9	
-	52,0	R1/8"	50,2	80,0	FLE207	UK207G2H	CO	CC	25,70	15,20	1,2	
48,0	-	R1/8"	50,2	80,0	FLE207	UC207G2	CO	CC	25,70	15,20	1,1	35
48,0	-	R1/8"	50,2	80,0	FLE207	US207G2	CO	CC	25,70	15,20	1,1	
-	55,6	R1/8"	59,5	80,0	FLE207	ES207G2	COE	CCE	25,70	15,20	1,2	
-	55,6	R1/8"	59,5	80,0	FLE207	EX207G2	COE	CCE	25,70	15,20	1,3	
-	58,0	R1/8"	57,9	88,0	FLE208	UK208G2H	CO	CC	29,60	18,20	1,7	



→ Two-bolt flanged unit

FLE200

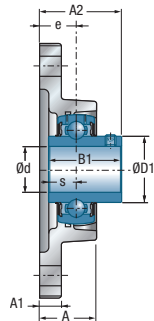
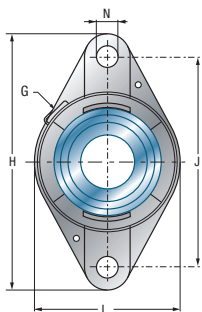

UCFLE200

Shaft diameter		Unit		Main dimensions [mm]										
d mm		L	H	J	A	A1	A2	e	N	s1	B	B1	s	
40	UCFLE208	105	172	143,5	37,5	13,0	54,2	24	14,0	-	-	49,2	19,0	
	USFLE208	105	172	143,5	37,5	13,0	49,0	24	14,0	-	-	34,0	9,0	
	ESFLE208	105	172	143,5	37,5	13,0	56,7	24	14,0	-	-	43,7	11,0	
	EXFLE208	105	172	143,5	37,5	13,0	58,9	24	14,0	-	-	56,3	21,4	
	UKFLE209H	111	180	148,5	37,5	13,0	50,0	24	14,0	26,0	50,0	-	-	
45	UCFLE209	111	180	148,5	37,5	13,0	54,2	24	14,0	-	-	49,2	19,0	
	USFLE209	111	180	148,5	37,5	13,0	55,0	24	14,0	-	-	41,2	10,2	
	ESFLE209	111	180	148,5	37,5	13,0	56,7	24	14,0	-	-	43,7	11,0	
	EXFLE209	111	180	148,5	37,5	13,0	58,9	24	14,0	-	-	56,3	21,4	
	UKFLE210H	116	190	157,0	41,6	13,0	55,5	28	18,0	27,5	55,0	-	-	
50	UCFLE210	116	190	157,0	41,6	13,0	60,6	28	18,0	-	-	51,6	19,0	
	USFLE210	116	190	157,0	41,6	13,0	60,6	28	18,0	-	-	43,5	10,9	
	ESFLE210	116	190	157,0	41,6	13,0	60,7	28	18,0	-	-	43,7	11,0	
	EXFLE210	116	190	157,0	41,6	13,0	66,1	28	18,0	-	-	62,7	24,6	
	UKFLE211H	134	222	184,0	45,8	15,0	60,0	31	18,0	29,0	59,0	-	-	
55	UCFLE211	134	222	184,0	45,8	15,0	64,4	31	18,0	-	-	55,6	22,2	
	USFLE211	134	222	184,0	45,8	15,0	64,5	31	18,0	-	-	45,3	11,8	
	ESFLE211	134	222	184,0	45,8	15,0	67,4	31	18,0	-	-	48,4	12,0	
	EXFLE211	134	222	184,0	45,8	15,0	74,6	31	18,0	-	-	71,3	27,7	
	UKFLE212H	138	238	202,0	50,4	16,0	65,0	34	18,0	31,0	62,0	-	-	
60	UCFLE212	138	238	202,0	50,4	16,0	73,7	34	18,0	-	-	65,1	25,4	
	USFLE212	138	238	202,0	50,4	16,0	72,8	34	18,0	-	-	53,7	14,9	
	ESFLE212	138	238	202,0	50,4	16,0	71,3	34	18,0	-	-	49,3	12,0	
	EXFLE212	138	238	202,0	50,4	16,0	80,8	34	18,0	-	-	77,7	30,9	
	UKFLE213H	160	258	216,0	57,0	18,0	70,0	38	21,0	32,0	65,0	-	-	
65	UCFLE213	160	258	216,0	57,0	18,0	77,7	38	21,0	-	-	65,1	25,4	
	EXFLE213	160	258	216,0	57,0	18,0	89,6	38	21,0	-	-	85,7	34,1	
	UKFLE215H	160	258	216,0	57,0	18,0	73,5	38	21,0	35,5	73,0	-	-	
70	UCFLE214	160	258	216,0	57,0	18,0	82,4	38	21,0	-	-	74,6	30,2	
	EXFLE214	160	258	216,0	57,0	18,0	89,6	38	21,0	-	-	85,7	34,1	
75	UCFLE215	160	258	216,0	57,0	18,0	82,5	38	21,0	-	-	77,8	33,3	
	EXFLE215	160	258	216,0	57,0	18,0	92,8	38	21,0	-	-	92,1	37,3	

* = equipped with one open protective cap for passing shafts; suffix CO or COE
 ** = equipped with one closed protective cap for shaft ends; suffix CC or CCE

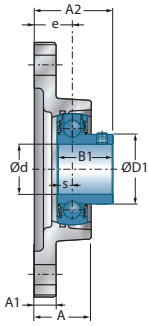

USFLE200

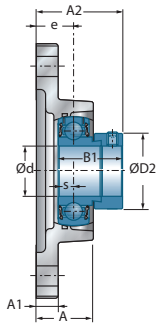

ESFLE200

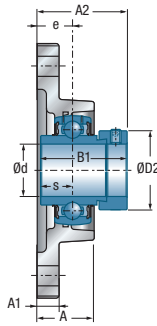

EXFLE200

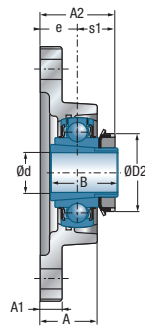

UKFLE200H

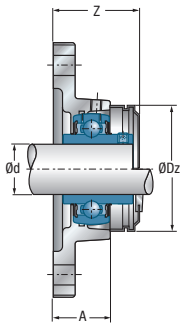

UCFLE200CO(CC)

Main dimensions [mm]

Main dimensions [mm]					Housing	Bearing insert	Open protective cap*	Closed protective cap**	Dynamic load rating	Static load rating	Weight	Shaft diameter
D1	D2	G	Z	Dz				C _r [kN]	C _{0r} [kN]	kg	d mm	
53,0	-	R1/8"	57,9	88,0	FLE208	UC208G2	CO	CC	29,60	18,20	1,6	40
53,0	-	R1/8"	57,9	88,0	FLE208	US208G2	CO	CC	29,60	18,20	1,6	
-	60,3	R1/8"	64,0	88,0	FLE208	ES208G2	COE	CCE	29,60	18,20	1,6	
-	60,3	R1/8"	64,0	88,0	FLE208	EX208G2	COE	CCE	29,60	18,20	1,8	
-	65,0	R1/8"	58,4	95,0	FLE209	UK209G2H	CO	CC	31,85	20,80	1,9	
57,2	-	R1/8"	58,4	95,0	FLE209	UC209G2	CO	CC	31,85	20,80	1,8	45
57,2	-	R1/8"	58,4	95,0	FLE209	US209G2	CO	CC	31,85	20,80	1,8	
-	63,5	R1/8"	65,5	95,0	FLE209	ES209G2	COE	CCE	31,85	20,80	1,8	
-	63,5	R1/8"	65,5	95,0	FLE209	EX209G2	COE	CCE	31,85	20,80	2,0	
-	70,0	R1/8"	65,8	100,0	FLE210	UK210G2H	CO	CC	35,10	23,20	2,3	
61,8	-	R1/8"	65,8	100,0	FLE210	UC210G2	CO	CC	35,10	23,20	2,1	50
61,8	-	R1/8"	65,8	100,0	FLE210	US210G2	CO	CC	35,10	23,20	2,1	
-	69,9	R1/8"	73,5	100,0	FLE210	ES210G2	COE	CCE	35,10	23,20	2,1	
-	69,9	R1/8"	73,5	100,0	FLE210	EX210G2	COE	CCE	35,10	23,20	2,3	
-	75,0	R1/8"	69,1	110,0	FLE211	UK211G2H	CO	CC	43,55	29,20	3,5	
69,0	-	R1/8"	69,1	110,0	FLE211	UC211G2	CO	CC	43,55	29,20	3,4	55
69,0	-	R1/8"	69,1	110,0	FLE211	US211G2	CO	CC	43,55	29,20	3,4	
-	76,2	R1/8"	82,5	110,0	FLE211	ES211G2	COE	CCE	43,55	29,20	3,2	
-	76,2	R1/8"	82,5	110,0	FLE211	EX211G2	COE	CCE	43,55	29,20	3,7	
-	80,0	R1/8"	82,4	120,0	FLE212	UK212G2H	CO	CC	52,50	32,80	3,7	
74,9	-	R1/8"	82,4	120,0	FLE212	UC212G2	CO	CC	52,50	32,80	3,7	60
74,9	-	R1/8"	82,4	120,0	FLE212	US212G2	CO	CC	52,50	32,80	3,5	
-	84,2	R1/8"	93,0	120,0	FLE212	ES212G2	COE	CCE	52,50	32,80	3,4	
-	84,2	R1/8"	93,0	120,0	FLE212	EX212G2	COE	CCE	52,50	32,80	4,0	
-	85,0	R1/8"	82,9	132,0	FLE213	UK213G2H	CO	CC	57,20	40,00	4,1	
82,0	-	R1/8"	82,9	132,0	FLE213	UC213G2	CO	CC	57,20	40,00	4,0	65
-	86,0	R1/8"	97,5	132,0	FLE213	EX213G2	COE	CCE	57,20	40,00	4,6	
-	98,0	R1/8"	-	-	FLE215	UK215G2H	-	-	66,00	49,50	4,9	
86,5	-	R1/8"	-	-	FLE214	UC214G2	-	-	62,00	45,00	5,4	70
-	96,8	R1/8"	-	-	FLE214	EX214G2	-	-	62,00	45,00	5,9	
91,5	-	R1/8"	-	-	FLE215	UC215G2	-	-	66,00	49,50	5,2	75
-	102,0	R1/8"	-	-	FLE215	EX215G2	-	-	66,00	49,50	5,8	



→ Two-bolt flanged unit

FL200

FL300

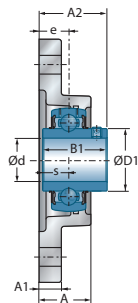
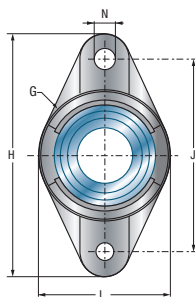
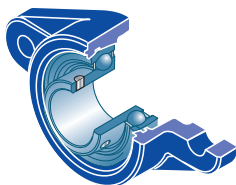

UCFL200
UCFL300

Shaft diameter		Unit		Main dimensions [mm]										
d mm		L	H	J	A	A1	A2	e	N	s1	B	B1	s	
12	UCFL201	60	113	90,0	25,5	11	33,3	15	12	-	-	31,0	12,7	
	USFL201	57	99	76,5	25,5	11	31,0	15	12	-	-	22,0	6,0	
	ESFL201	57	99	76,5	25,5	11	37,1	15	12	-	-	28,6	6,5	
	EXFL201	60	113	90,0	25,5	11	41,5	15	12	-	-	43,5	17,0	
15	UCFL202	60	113	90,0	25,5	11	33,3	15	12	-	-	31,0	12,7	
	USFL202	57	99	76,5	25,5	11	31,0	15	12	-	-	22,0	6,0	
	ESFL202	57	99	76,5	25,5	11	37,1	15	12	-	-	28,6	6,5	
	EXFL202	60	113	90,0	25,5	11	41,5	15	12	-	-	43,5	17,0	
17	UCFL203	60	113	90,0	25,5	11	33,3	15	12	-	-	31,0	12,7	
	USFL203	57	99	76,5	25,5	11	31,0	15	12	-	-	22,0	6,0	
	ESFL203	57	99	76,5	25,5	11	37,1	15	12	-	-	28,6	6,5	
	EXFL203	60	113	90,0	25,5	11	41,5	15	12	-	-	43,5	17,0	
20	UCFL204	60	113	90,0	25,5	11	33,3	15	12	-	-	31,0	12,7	
	USFL204	60	113	90,0	25,5	11	33,0	15	12	-	-	25,0	7,0	
	ESFL204	60	113	90,0	25,5	11	38,4	15	12	-	-	30,9	7,5	
	EXFL204	60	113	90,0	25,5	11	41,5	15	12	-	-	43,5	17,0	
	UKFL205H	68	130	99,0	27,0	13	34,5	16	16	18,5	35,0	-	-	
	UKFL305H	80	150	113,0	29,0	13	37,5	16	19	21,5	35,0	-	-	
25	UCFL205	68	130	99,0	27,0	13	35,7	16	16	-	-	34,0	14,3	
	USFL205	68	130	99,0	27,0	13	35,5	16	16	-	-	27,0	7,5	
	ESFL205	68	130	99,0	27,0	13	39,4	16	16	-	-	30,9	7,5	
	EXFL205	68	130	99,0	27,0	13	42,9	16	16	-	-	44,3	17,4	
	UKFL206H	80	148	117,0	31,0	13	38,5	18	16	20,5	38,0	-	-	
	UCFL305	80	150	113,0	29,0	13	39,0	16	19	-	-	38,0	15,0	
	EXFL305	80	150	113,0	29,0	13	46,1	16	19	-	-	46,8	16,7	
	UKFL306H	90	180	134,0	32,0	15	41,0	18	23	23,0	38,0	-	-	
30	UCFL206	80	148	117,0	31,0	13	40,2	18	16	-	-	38,1	15,9	
	USFL206	80	148	117,0	31,0	13	40,0	18	16	-	-	30,0	8,0	
	ESFL206	80	148	117,0	31,0	13	44,7	18	16	-	-	35,7	9,0	
	EXFL206	80	148	117,0	31,0	13	48,1	18	16	-	-	48,3	18,2	
	UKFL207H	90	161	130,0	34,0	14	41,5	19	16	22,5	43,0	-	-	
	UCFL306	90	180	134,0	32,0	15	44,0	18	23	-	-	43,0	17,0	
	EXFL306	90	180	134,0	32,0	15	50,5	18	23	-	-	50,0	17,5	
	UKFL307H	100	185	141,0	36,0	16	45,5	20	23	25,5	43,0	-	-	

* = equipped with one open protective cap for passing shafts; suffix CO or COE
 ** = equipped with one closed protective cap for shaft ends; suffix CC or CCE

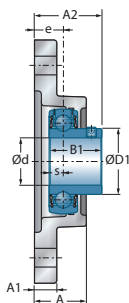

USFL200

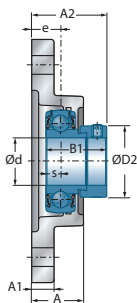

ESFL200

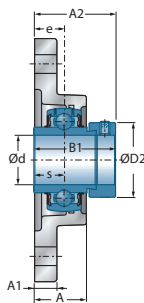

EXFL200
EXFL300

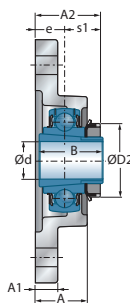

UKFL200H
UKFL300H

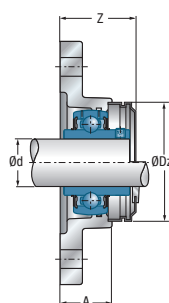

UCFL200C0(CC)

Main dimensions [mm]

Main dimensions [mm]					Housing	Bearing insert	Open protective cap*	Closed protective cap**	Dynamic load rating	Static load rating	Weight	Shaft diameter
D1	D2	G	Z	Dz					C _r [kN]	C _{0r} [kN]	kg	d mm
29,0	-	M6x1	36,5	54,0	FL204	UC201G2	CO	CC	12,80	6,65	0,5	12
24,6	-	M6x1	35,8	46,0	FL203	US201G2	CO	CC	9,55	4,78	0,4	
-	28,6	M6x1	42,5	46,0	FL203	ES201G2	COE	CCE	9,55	4,78	0,4	
-	33,3	M6x1	45,7	54,0	FL204	EX201G2	COE	CCE	12,80	6,65	0,6	
29,0	-	M6x1	36,5	54,0	FL204	UC202G2	CO	CC	12,80	6,65	0,5	15
24,6	-	M6x1	35,8	46,0	FL203	US202G2	CO	CC	9,55	4,78	0,3	
-	28,6	M6x1	42,5	46,0	FL203	ES202G2	COE	CCE	9,55	4,78	0,4	
-	33,3	M6x1	45,7	54,0	FL204	EX202G2	COE	CCE	12,80	6,65	0,5	
29,0	-	M6x1	36,5	54,0	FL204	UC203G2	CO	CC	12,80	6,65	0,4	17
24,6	-	M6x1	35,8	46,0	FL203	US203G2	CO	CC	9,55	4,78	0,4	
-	28,6	M6x1	42,5	46,0	FL203	ES203G2	COE	CCE	9,55	4,78	0,4	
-	33,3	M6x1	45,7	54,0	FL204	EX203G2	COE	CCE	12,80	6,65	0,5	
29,0	-	M6x1	36,5	54,0	FL204	UC204G2	CO	CC	12,80	6,65	0,4	20
29,0	-	M6x1	36,5	54,0	FL204	US204G2	CO	CC	12,80	6,65	0,4	
-	33,3	M6x1	45,7	54,0	FL204	ES204G2	COE	CCE	12,80	6,65	0,4	
-	33,3	M6x1	45,7	54,0	FL204	EX204G2	COE	CCE	12,80	6,65	0,5	
-	38,0	M6x1	39,1	60,0	FL205	UK205G2H	CO	CC	14,00	7,88	0,7	
-	38,0	M6x1	-	-	FL305	UK305G2H	-	-	22,36	11,50	1,1	
34,0	-	M6x1	39,1	60,0	FL205	UC205G2	CO	CC	14,00	7,88	0,6	25
34,0	-	M6x1	39,1	60,0	FL205	US205G2	CO	CC	14,00	7,88	0,6	
-	38,1	M6x1	44,7	60,0	FL205	ES205G2	COE	CCE	14,00	7,88	0,6	
-	38,1	M6x1	44,7	60,0	FL205	EX205G2	COE	CCE	14,00	7,88	0,7	
-	45,0	M6x1	45,2	70,0	FL206	UK206G2H	CO	CC	19,50	11,20	1,0	
35,4	-	M6x1	-	-	FL305	UC305G2	-	-	22,36	11,50	0,9	
-	42,8	M6x1	-	-	FL305	EX305G2	-	-	22,36	11,50	1,0	
-	45,0	M6x1	-	-	FL306	UK306G2H	-	-	27,00	15,20	1,4	
40,3	-	M6x1	45,2	70,0	FL206	UC206G2	CO	CC	19,50	11,20	0,9	30
40,3	-	M6x1	45,2	70,0	FL206	US206G2	CO	CC	19,50	11,20	0,9	
-	44,5	M6x1	54,3	70,0	FL206	ES206G2	COE	CCE	19,50	11,20	0,9	
-	44,5	M6x1	54,3	70,0	FL206	EX206G2	COE	CCE	19,50	11,20	1,0	
-	52,0	M6x1	48,2	80,0	FL207	UK207G2H	CO	CC	25,70	15,20	1,2	
44,6	-	M6x1	-	-	FL306	UC306G2	-	-	27,00	15,20	1,4	
-	50,0	M6x1	-	-	FL306	EX306G2	-	-	27,00	15,20	1,5	
-	52,0	M6x1	-	-	FL307	UK307G2H	-	-	33,50	19,20	1,9	



→ Two-bolt flanged unit

FL200

FL300

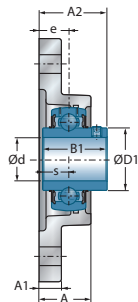
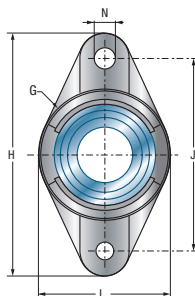

UCFL200
UCFL300

Shaft diameter		Unit		Main dimensions [mm]									
d mm		L	H	J	A	A1	A2	e	N	s1	B	B1	s
35	UCFL207	90	161	130,0	34,0	14	44,4	19	16	-	-	42,9	17,5
	USFL207	90	161	130,0	34,0	14	42,5	19	16	-	-	32,0	8,5
	ESFL207	90	161	130,0	34,0	14	48,4	19	16	-	-	38,9	9,5
	EXFL207	90	161	130,0	34,0	14	51,3	19	16	-	-	51,1	18,8
	UKFL208H	100	175	144,0	36,0	14	45,5	21	16	24,5	46,0	-	-
	UCFL307	100	185	141,0	36,0	16	49,0	20	23	-	-	48,0	19,0
	EXFL307	100	185	141,0	36,0	16	53,3	20	23	-	-	51,6	18,3
	UKFL308H	112	200	158,0	40,0	17	50,5	23	23	27,5	46,0	-	-
40	UCFL208	100	175	144,0	36,0	14	51,2	21	16	-	-	49,2	19,0
	USFL208	100	175	144,0	36,0	14	46,0	21	16	-	-	34,0	9,0
	ESFL208	100	175	144,0	36,0	14	53,7	21	16	-	-	43,7	11,0
	EXFL208	100	175	144,0	36,0	14	55,9	21	16	-	-	56,3	21,4
	UKFL209H	108	188	148,0	38,0	16	48,0	22	19	26,0	50,0	-	-
	UCFL308	112	200	158,0	40,0	17	56,0	23	23	-	-	52,0	19,0
	EXFL308	112	200	158,0	40,0	17	60,3	23	23	-	-	57,1	19,8
	UKFL309H	125	230	177,0	44,0	18	55,0	25	25	30,0	50,0	-	-
45	UCFL209	108	188	148,0	38,0	16	52,2	22	19	-	-	49,2	19,0
	USFL209	108	188	148,0	38,0	16	53,0	22	19	-	-	41,2	10,2
	ESFL209	108	188	148,0	38,0	16	54,7	22	19	-	-	43,7	11,0
	EXFL209	108	188	148,0	38,0	16	56,9	22	19	-	-	56,3	21,4
	UKFL210H	115	197	157,0	40,0	16	49,5	22	19	27,5	55,0	-	-
	UCFL309	125	230	177,0	44,0	18	60,0	25	25	-	-	57,0	22,0
	EXFL309	125	230	177,0	44,0	18	63,9	25	25	-	-	58,7	19,8
	UKFL310H	140	240	187,0	48,0	19	60,0	28	25	32,0	55,0	-	-
50	UCFL210	115	197	157,0	40,0	16	54,6	22	19	-	-	51,6	19,0
	USFL210	115	197	157,0	40,0	16	54,6	22	19	-	-	43,5	10,9
	ESFL210	115	197	157,0	40,0	16	54,7	22	19	-	-	43,7	11,0
	EXFL210	115	197	157,0	40,0	16	60,1	22	19	-	-	62,7	24,6
	UKFL211H	130	224	184,0	43,0	18	54,0	25	19	29,0	59,0	-	-
	UCFL310	140	240	187,0	48,0	19	67,0	28	25	-	-	61,0	22,0
	EXFL310	140	240	187,0	48,0	19	70,0	28	25	-	-	66,6	24,6
	UKFL311H	150	250	198,0	52,0	20	64,0	30	25	34,0	59,0	-	-

* = equipped with one open protective cap for passing shafts; suffix CO or COE
 ** = equipped with one closed protective cap for shaft ends; suffix CC or CCE

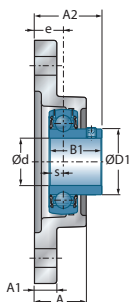

USFL200

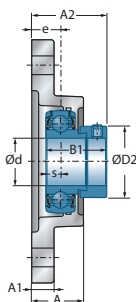

ESFL200

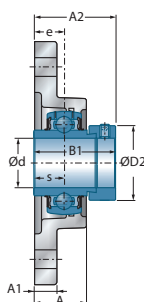

EXFL200
EXFL300

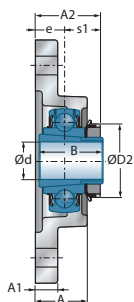

UKFL200H
UKFL300H

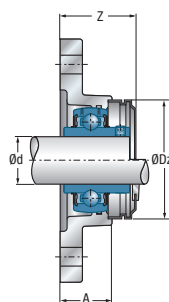

UCFL200CO(CC)

Main dimensions [mm]

Main dimensions [mm]					Housing	Bearing insert	Open protective cap*	Closed protective cap**	Dynamic load rating	Static load rating	Weight	Shaft diameter
D1	D2	G	Z	Dz					C _r [kN]	C _{0r} [kN]	kg	d mm
48,0	-	M6x1	48,2	80,0	FL207	UC207G2	CO	CC	25,70	15,20	1,2	35
48,0	-	M6x1	48,2	80,0	FL207	US207G2	CO	CC	25,70	15,20	1,1	
-	55,6	M6x1	57,5	80,0	FL207	ES207G2	COE	CCE	25,70	15,20	1,2	
-	55,6	M6x1	57,5	80,0	FL207	EX207G2	COE	CCE	25,70	15,20	1,3	
-	58,0	M6x1	55,1	88,0	FL208	UK208G2H	CO	CC	29,60	18,20	1,6	
48,9	-	M6x1	-	-	FL307	UC307G2	-	-	33,50	19,20	1,7	
-	55,0	M6x1	-	-	FL307	EX307G2	-	-	33,50	19,20	1,8	
-	58,0	M6x1	-	-	FL308	UK308G2H	-	-	40,56	24,00	2,3	
53,0	-	M6x1	55,1	88,0	FL208	UC208G2	CO	CC	29,60	18,20	1,5	40
53,0	-	M6x1	55,1	88,0	FL208	US208G2	CO	CC	29,60	18,20	1,5	
-	60,3	M6x1	61,2	88,0	FL208	ES208G2	COE	CCE	29,60	18,20	1,5	
-	60,3	M6x1	61,2	88,0	FL208	EX208G2	COE	CCE	29,60	18,20	1,6	
-	65,0	M6x1	56,3	95,0	FL209	UK209G2H	CO	CC	31,85	20,80	2,0	
56,5	-	M6x1	-	-	FL308	UC308G2	-	-	40,56	24,00	2,2	
-	63,5	M6x1	-	-	FL308	EX308G2	-	-	40,56	24,00	2,3	
-	65,0	M6x1	-	-	FL309	UK309G2H	-	-	53,00	31,80	3,3	
57,2	-	M6x1	56,3	95,0	FL209	UC209G2	CO	CC	31,85	20,80	1,9	45
57,2	-	M6x1	56,3	95,0	FL209	US209G2	CO	CC	31,85	20,80	1,8	
-	63,5	M6x1	63,4	95,0	FL209	ES209G2	COE	CCE	31,85	20,80	1,9	
-	63,5	M6x1	63,4	95,0	FL209	EX209G2	COE	CCE	31,85	20,80	2,1	
-	70,0	M6x1	60,1	100,0	FL210	UK210G2H	CO	CC	35,10	23,20	2,4	
61,8	-	M6x1	-	-	FL309	UC309G2	-	-	53,00	31,80	3,1	
-	70,0	M6x1	-	-	FL309	EX309G2	-	-	53,00	31,80	3,3	
-	70,0	M6x1	-	-	FL310	UK310G2H	-	-	62,00	37,80	4,1	
61,8	-	M6x1	60,1	100,0	FL210	UC210G2	CO	CC	35,10	23,20	2,2	50
61,8	-	M6x1	60,1	100,0	FL210	US210G2	CO	CC	35,10	23,20	2,2	
-	69,9	M6x1	67,8	100,0	FL210	ES210G2	COE	CCE	35,10	23,20	2,2	
-	69,9	M6x1	67,8	100,0	FL210	EX210G2	COE	CCE	35,10	23,20	2,4	
-	75,0	M6x1	63,7	110,0	FL211	UK211G2H	CO	CC	43,55	29,20	3,1	
68,7	-	M6x1	-	-	FL310	UC310G2	-	-	62,00	37,80	4,0	
-	76,2	M6x1	-	-	FL310	EX310G2	-	-	62,00	37,80	4,2	
-	75,0	M6x1	-	-	FL311	UK311G2H	-	-	71,50	44,80	4,9	



→ Two-bolt flanged unit

FL200

FL300

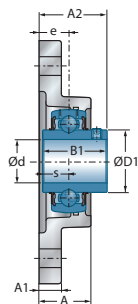
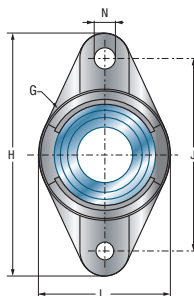
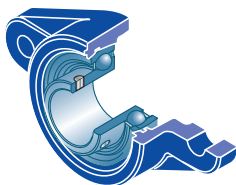

UCFL200
UCFL300

Shaft diameter		Unit		Main dimensions [mm]												
d mm		L	H	J	A	A1	A2	e	N	s1	B	B1	s			
55	UCFL211	130	224	184,0	43,0	18	58,4	25	19	-	-	55,6	22,2			
	USFL211	130	224	184,0	43,0	18	58,5	25	19	-	-	45,3	11,8			
	ESFL211	130	224	184,0	43,0	18	61,4	25	19	-	-	48,4	12,0			
	EXFL211	130	224	184,0	43,0	18	68,6	25	19	-	-	71,3	27,7			
	UKFL212H	140	250	202,0	48,0	18	60,0	29	23	31,0	62,0	-	-			
	UCFL311	150	250	198,0	52,0	20	71,0	30	25	-	-	66,0	25,0			
	EXFL311	150	250	198,0	52,0	20	75,2	30	25	-	-	73,0	27,8			
	UKFL312H	160	270	212,0	56,0	22	69,5	33	31	36,5	62,0	-	-			
60	UCFL212	140	250	202,0	48,0	18	68,7	29	23	-	-	65,1	25,4			
	USFL212	140	250	202,0	48,0	18	67,8	29	23	-	-	53,7	14,9			
	ESFL212	140	250	202,0	48,0	18	66,3	29	23	-	-	49,3	12,0			
	EXFL212	140	250	202,0	48,0	18	75,8	29	23	-	-	77,7	30,9			
	UKFL213H	155	258	210,0	50,0	20	62,0	30	23	32,0	65,0	-	-			
	UCFL312	160	270	212,0	56,0	22	78,0	33	31	-	-	71,0	26,0			
	EXFL312	160	270	212,0	56,0	22	81,4	33	31	-	-	79,4	31,0			
	UKFL313H	175	295	240,0	58,0	25	71,5	33	31	38,5	65,0	-	-			
65	UCFL213	155	258	210,0	50,0	20	69,7	30	23	-	-	65,1	25,4			
	EXFL213	155	258	210,0	50,0	20	81,6	30	23	-	-	85,7	34,1			
	UKFL215H	164	275	225,0	55,0	22	69,5	34	23	35,5	73,0	-	-			
	UCFL313	175	295	240,0	58,0	25	78,0	33	31	-	-	75,0	30,0			
	EXFL313	175	295	240,0	58,0	25	86,2	33	31	-	-	85,7	32,5			
	UKFL315H	195	320	260,0	66,0	30	81,5	39	35	42,5	73,0	-	-			
70	UCFL214	160	265	216,0	54,0	20	75,4	31	23	-	-	74,6	30,2			
	EXFL214	160	265	216,0	54,0	20	82,6	31	23	-	-	85,7	34,1			
	UKFL216H	180	290	233,0	58,0	22	73,0	34	25	39,0	78,0	-	-			
	UCFL314	185	315	250,0	61,0	28	83,0	36	35	-	-	78,0	33,0			
	EXFL314	185	315	250,0	61,0	28	93,9	36	35	-	-	92,1	34,2			
	UKFL316H	210	355	285,0	68,0	32	82,5	38	38	44,5	78,0	-	-			
75	UCFL215	164	275	225,0	55,0	22	78,5	34	23	-	-	77,8	33,3			
	EXFL215	164	275	225,0	55,0	22	88,8	34	23	-	-	92,1	37,3			
	UKFL217H	190	305	248,0	63,0	22	76,0	36	25	40,0	82,0	-	-			
	UCFL315	195	320	260,0	66,0	30	89,0	39	35	-	-	82,0	32,0			
	EXFL315	195	320	260,0	66,0	30	101,7	39	35	-	-	100,0	37,3			
	UKFL317H	220	370	300,0	74,0	32	92,0	44	38	48,0	82,0	-	-			

* = equipped with one open protective cap for passing shafts; suffix CO or COE
 ** = equipped with one closed protective cap for shaft ends; suffix CC or CCE

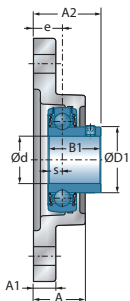

USFL200

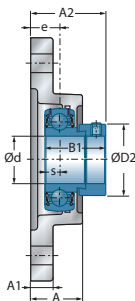

ESFL200

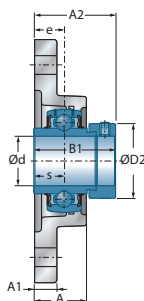

EXFL200
EXFL300

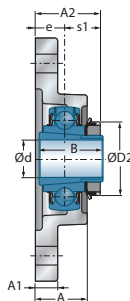

UKFL200H
UKFL300H

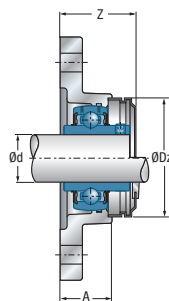

UCFL200CO(CC)

Main dimensions [mm]

Main dimensions [mm]					Housing	Bearing insert	Open protective cap*	Closed protective cap**	Dynamic load rating	Static load rating	Weight	Shaft diameter	
D1	D2	G	Z	Dz					C _r [kN]	C _{0r} [kN]	kg	d mm	
69,0	-	M6x1	63,7	110,0	FL211	UC211G2	CO	CC	43,55	29,20	3,0	55	
69,0	-	M6x1	63,7	110,0	FL211	US211G2	CO	CC	43,55	29,20	2,9		
-	76,2	M6x1	77,1	110,0	FL211	ES211G2	COE	CCE	43,55	29,20	2,7		
-	76,2	M6x1	77,1	110,0	FL211	EX211G2	COE	CCE	43,55	29,20	3,3		
-	80,0	M6x1	74,0	120,0	FL212	UK212G2H	CO	CC	52,50	32,80	3,8		
74,9	-	M6x1	-	-	FL311	UC311G2	-	-	71,50	44,80	4,6		
-	83,0	M6x1	-	-	FL311	EX311G2	-	-	71,50	44,80	5,0		
-	80,0	M6x1	-	-	FL312	UK312G2H	-	-	81,60	51,80	5,7		
74,9	-	M6x1	74,0	120,0	FL212	UC212G2	CO	CC	52,50	32,80	3,9		60
74,9	-	M6x1	74,0	120,0	FL212	US212G2	CO	CC	52,50	32,80	3,6		
-	84,2	M6x1	84,6	120,0	FL212	ES212G2	COE	CCE	52,50	32,80	3,5		
-	84,2	M6x1	84,6	120,0	FL212	EX212G2	COE	CCE	52,50	32,80	4,2		
-	85,0	M6x1	74,3	132,0	FL213	UK213G2H	CO	CC	57,20	40,00	4,8		
81,0	-	M6x1	-	-	FL312	UC312G2	-	-	81,60	51,80	5,8		
-	89,0	M6x1	-	-	FL312	EX312G2	-	-	81,60	51,80	6,1		
-	85,0	M6x1	-	-	FL313	UK313G2H	-	-	93,86	60,50	7,4		
82,0	-	M6x1	74,3	132,0	FL213	UC213G2	CO	CC	57,20	40,00	4,8	65	
-	86,0	M6x1	88,9	132,0	FL213	EX213G2	COE	CCE	57,20	40,00	5,3		
-	98,0	M10x1	-	-	FL215	UK215G2H	-	-	66,00	49,50	5,7		
87,5	-	M6x1	-	-	FL313	UC313G2	-	-	93,86	60,50	7,3		
-	97,0	M6x1	-	-	FL313	EX313G2	-	-	93,86	60,50	7,8		
-	98,0	M10x1	-	-	FL315	UK315G2H	-	-	113,36	76,80	10,2		
86,5	-	M10x1	-	-	FL214	UC214G2	-	-	62,00	45,00	5,4		70
-	96,8	M10x1	-	-	FL214	EX214G2	-	-	62,00	45,00	5,9		
-	105,0	M10x1	-	-	FL216	UK216G2H	-	-	72,50	54,20	7,5		
94,0	-	M10x1	-	-	FL314	UC314G2	-	-	104,26	68,00	8,7		
-	102,0	M10x1	-	-	FL314	EX314G2	-	-	104,26	68,00	9,3		
-	105,0	M10x1	-	-	FL316	UK316G2H	-	-	122,85	86,50	12,8		
91,5	-	M10x1	-	-	FL215	UC215G2	-	-	66,00	49,50	5,4	75	
-	102,0	M10x1	-	-	FL215	EX215G2	-	-	66,00	49,50	6,0		
-	110,0	M10x1	-	-	FL217	UK217G2H	-	-	83,20	63,80	9,0		
100,5	-	M10x1	-	-	FL315	UC315G2	-	-	113,36	76,80	9,5		
-	113,0	M10x1	-	-	FL315	EX315G2	-	-	113,36	76,80	10,6		
-	110,0	M10x1	-	-	FL317	UK317G2H	-	-	132,60	96,50	14,4		



→ Two-bolt flanged unit

FL200

FL300

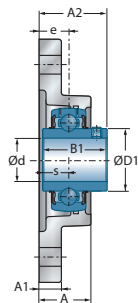
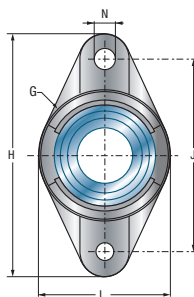

UCFL200
UCFL300

Shaft diameter		Unit		Main dimensions [mm]										
d mm		L	H	J	A	A1	A2	e	N	s1	B	B1	s	
80	UCFL216	180	290	233,0	58,0	22	83,3	34	25	-	-	82,6	33,3	
	EXFL216	180	290	233,0	58,0	22	91,9	34	25	-	-	95,2	37,3	
	UKFL218H	205	320	265,0	68,0	23	82,0	40	25	42,0	86,0	-	-	
	UCFL316	210	355	285,0	68,0	32	90,0	38	38	-	-	86,0	34,0	
	EXFL316	210	355	285,0	68,0	32	103,9	38	38	-	-	106,4	40,5	
	UKFL318H	235	385	315,0	76,0	36	92,0	44	38	48,0	86,0	-	-	
85	UCFL217	190	305	248,0	63,0	22	87,6	36	25	-	-	85,7	34,1	
	EXFL217	190	305	248,0	63,0	22	83,6	36	25	-	-	73,2	23,4	
	UCFL317	220	370	300,0	74,0	32	100,0	44	38	-	-	96,0	40,0	
	EXFL317	220	370	300,0	74,0	32	111,5	44	38	-	-	109,5	42,0	
	UKFL319H	250	405	330,0	94,0	40	111,0	59	41	52,0	90,0	-	-	
	90	UCFL218	205	320	265,0	68,0	23	96,3	40	25	-	-	96,0	39,7
EXFL218		205	320	265,0	68,0	23	86,5	40	25	-	-	72,5	24,5	
UCFL318		235	385	315,0	76,0	36	100,0	44	38	-	-	96,0	40,0	
EXFL318		235	385	315,0	76,0	36	116,3	44	38	-	-	115,9	43,6	
UKFL320H		270	440	360,0	94,0	40	113,0	59	44	54,0	97,0	-	-	
95		UCFL319	250	405	330,0	94,0	40	121,0	59	41	-	-	103,0	41,0
	EXFL319	250	405	330,0	94,0	40	134,5	59	41	-	-	122,3	46,8	
100	UCFL320	270	440	360,0	94,0	40	125,0	59	44	-	-	108,0	42,0	
	EXFL320	270	440	360,0	94,0	40	137,6	59	44	-	-	128,6	50,0	
	UKFL322H	300	470	390,0	96,0	42	121,0	60	44	61,0	105,0	-	-	
105	UCFL321	270	440	360,0	94,0	40	127,0	59	44	-	-	112,0	44,0	
110	UCFL322	300	470	390,0	96,0	42	131,0	60	44	-	-	117,0	46,0	
	UKFL324H	330	520	430,0	110,0	48	130,0	65	47	65,0	112,0	-	-	
115	UKFL326H	360	550	460,0	115,0	50	134,0	65	47	69,0	121,0	-	-	
120	UCFL324	330	520	430,0	110,0	48	140,0	65	47	-	-	126,0	51,0	
125	UKFL328H	400	600	500,0	125,0	60	148,0	75	51	73,0	131,0	-	-	
130	UCFL326	360	550	460,0	115,0	50	146,0	65	47	-	-	135,0	54,0	
140	UCFL328	400	600	500,0	125,0	60	161,0	75	51	-	-	145,0	59,0	

* = equipped with one open protective cap for passing shafts; suffix CO or CCE
 ** = equipped with one closed protective cap for shaft ends; suffix CC or CCE

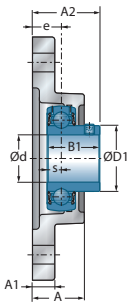

USFL200

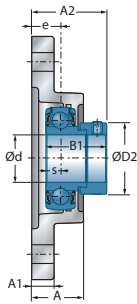

ESFL200

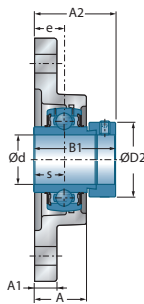

EXFL200
EXFL300

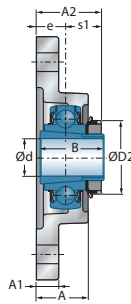

UKFL200H
UKFL300H

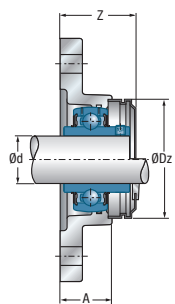

UCFL200CO(CC)

Main dimensions [mm]

Main dimensions [mm]					Housing	Bearing insert	Open protective cap*	Closed protective cap**	Dynamic load rating	Static load rating	Weight	Shaft diameter
D1	D2	G	Z	Dz					C _r [kN]	C _{0r} [kN]	kg	d mm
98,0	-	M10x1	-	-	FL216	UC216G2	-	-	72,50	54,20	7,1	80
-	110,0	M10x1	-	-	FL216	EX216G2	-	-	72,50	54,20	7,4	
-	120,0	M10x1	-	-	FL218	UK218G2H	-	-	96,00	71,50	11,2	
107,9	-	M10x1	-	-	FL316	UC316G2	-	-	122,85	86,50	12,5	
-	119,0	M10x1	-	-	FL316	EX316G2	-	-	122,85	86,50	13,6	
-	120,0	M10x1	-	-	FL318	UK318G2H	-	-	143,00	108,00	17,1	
105,1	-	M10x1	-	-	FL217	UC217G2	-	-	83,20	63,80	8,5	85
-	119,0	M10x1	-	-	FL217	EX217G2	-	-	83,20	63,80	8,9	
114,0	-	M10x1	-	-	FL317	UC317G2	-	-	132,60	96,50	14,4	
-	127,0	M10x1	-	-	FL317	EX317G2	-	-	132,60	96,50	15,5	
-	125,0	M10x1	-	-	FL319	UK319G2H	-	-	156,00	122,00	21,6	
111,0	-	M10x1	-	-	FL218	UC218G2	-	-	96,00	71,50	10,9	90
-	120,0	M10x1	-	-	FL218	EX218G2	-	-	96,00	71,50	11,4	
120,0	-	M10x1	-	-	FL318	UC318G2	-	-	143,00	108,00	17,0	
-	133,0	M10x1	-	-	FL318	EX318G2	-	-	143,00	108,00	18,3	
-	130,0	M10x1	-	-	FL320	UK320G2H	-	-	171,60	140,00	25,9	
126,5	-	M10x1	-	-	FL319	UC319G2	-	-	156,00	122,00	21,3	95
-	140,0	M10x1	-	-	FL319	EX319G2	-	-	156,00	122,00	22,8	
134,5	-	M10x1	-	-	FL320	UC320G2	-	-	171,60	140,00	26,1	100
-	146,0	M10x1	-	-	FL320	EX320G2	-	-	171,60	140,00	27,9	
-	145,0	M10x1	-	-	FL322	UK322G2H	-	-	205,00	178,00	35,9	
140,5	-	M10x1	-	-	FL321	UC321G2	-	-	182,00	155,00	25,0	105
149,0	-	M10x1	-	-	FL322	UC322G2	-	-	205,00	178,00	32,6	110
-	155,0	M10x1	-	-	FL324	UK324G2H	-	-	228,00	208,00	47,7	
-	165,0	M10x1	-	-	FL326	UK326G2H	-	-	252,00	242,00	61,3	115
163,0	-	M10x1	-	-	FL324	UC324G2	-	-	228,00	208,00	45,0	120
-	180,0	M10x1	-	-	FL328	UK328G2H	-	-	275,00	272,00	83,6	125
177,0	-	M10x1	-	-	FL326	UC326G2	-	-	252,00	242,00	56,4	130
190,0	-	M10x1	-	-	FL328	UC328G2	-	-	275,00	272,00	77,6	140

→ Two-bolt piloted flange unit

FLZ200

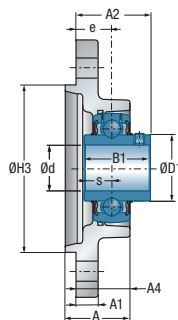
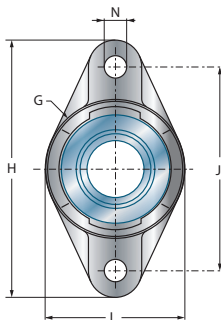
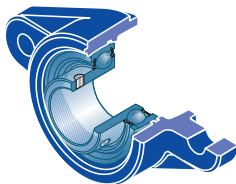

UCFLZ200

Shaft diameter		Unit		Main dimensions [mm]								
d mm		L	H	J	A	A1	A2	A4	H3 h8	e	N	s1
12	UCFLZ201	60,5	112,5	90,0	32,0	10,0	37,3	28,5	55	19	11,5	-
	USFLZ201	60,5	112,5	90,0	32,0	8,0	35,0	28,5	55	19	11,5	-
	ESFLZ201	60,5	112,5	90,0	32,0	8,0	41,1	28,5	55	19	11,5	-
	EXFLZ201	60,5	112,5	90,0	32,0	10,0	45,5	28,5	55	19	11,5	-
15	UCFLZ202	60,5	112,5	90,0	32,0	10,0	37,3	28,5	55	19	11,5	-
	USFLZ202	60,5	112,5	90,0	32,0	8,0	35,0	28,5	55	19	11,5	-
	ESFLZ202	60,5	112,5	90,0	32,0	8,0	41,1	28,5	55	19	11,5	-
	EXFLZ202	60,5	112,5	90,0	32,0	10,0	45,5	28,5	55	19	11,5	-
17	UCFLZ203	60,5	112,5	90,0	32,0	10,0	37,3	28,5	55	19	11,5	-
	USFLZ203	60,5	112,5	90,0	32,0	8,0	35,0	28,5	55	19	11,5	-
	ESFLZ203	60,5	112,5	90,0	32,0	8,0	41,1	28,5	55	19	11,5	-
	EXFLZ203	60,5	112,5	90,0	32,0	10,0	45,5	28,5	55	19	11,5	-
20	UCFLZ204	60,5	112,5	90,0	32,0	10,0	37,3	28,5	55	19	11,5	-
	USFLZ204	60,5	112,5	90,0	32,0	10,0	37,0	28,5	55	19	11,5	-
	ESFLZ204	60,5	112,5	90,0	32,0	10,0	42,4	28,5	55	19	11,5	-
	EXFLZ204	60,5	112,5	90,0	32,0	10,0	45,5	28,5	55	19	11,5	-
	UKFLZ205H	70,0	124,0	99,0	32,5	12,0	37,5	29,0	60	19	11,5	18,5
25	UCFLZ205	70,0	124,0	99,0	32,5	12,0	38,7	29,0	60	19	11,5	-
	USFLZ205	70,0	124,0	99,0	32,5	12,0	38,5	29,0	60	19	11,5	-
	ESFLZ205	70,0	124,0	99,0	32,5	12,0	42,4	29,0	60	19	11,5	-
	EXFLZ205	70,0	124,0	99,0	32,5	12,0	45,9	29,0	60	19	11,5	-
	UKFLZ206H	83,0	142,0	116,5	30,0	12,0	37,5	27,0	80	17	11,5	20,5
30	UCFLZ206	83,0	142,0	116,5	30,0	12,0	39,2	27,0	80	17	11,5	-
	USFLZ206	83,0	142,0	116,5	30,0	12,0	39,0	27,0	80	17	11,5	-
	ESFLZ206	83,0	142,0	116,5	30,0	12,0	43,7	27,0	80	17	11,5	-
	EXFLZ206	83,0	142,0	116,5	30,0	12,0	47,1	27,0	80	17	11,5	-
	UKFLZ207H	94,0	155,0	130,0	32,5	12,5	39,5	28,5	90	17	14,0	22,5
35	UCFLZ207	94,0	155,0	130,0	32,5	12,5	42,4	28,5	90	17	14,0	-
	USFLZ207	94,0	155,0	130,0	32,5	12,5	40,5	28,5	90	17	14,0	-
	ESFLZ207	94,0	155,0	130,0	32,5	12,5	46,4	28,5	90	17	14,0	-
	EXFLZ207	94,0	155,0	130,0	32,5	12,5	49,3	28,5	90	17	14,0	-
	UKFLZ208H	105,0	172,0	143,5	36,0	13,0	44,5	32,0	100	20	14,0	24,5

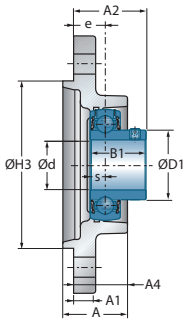

USFLZ200

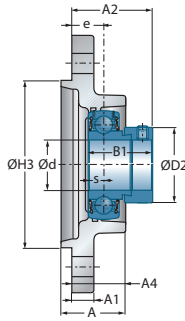

ESFLZ200

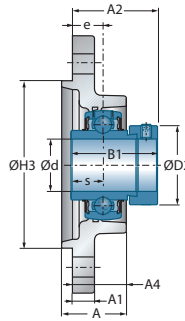

EXFLZ200

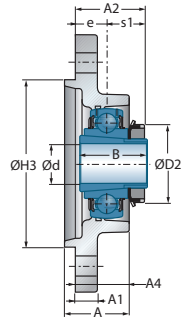

UKFLZ200H

Main dimensions [mm]

Main dimensions [mm]						Housing	Bearing insert	Dynamic load rating		Static load rating	Weight	Shaft diameter
B	B1	s	D1	D2	G			C_r [kN]	C_{Or} [kN]		kg	d mm
-	31,0	12,7	29,0	-	R1/8"	FLZ204	UC201G2	12,80	6,65	0,5		12
-	22,0	6,0	24,6	-	R1/8"	FLZ203	US201G2	9,55	4,78	0,4		
-	28,6	6,5	-	28,6	R1/8"	FLZ203	ES201G2	9,55	4,78	0,4		
-	43,5	17,0	-	33,3	R1/8"	FLZ204	EX201G2	12,80	6,65	0,6		
-	31,0	12,7	29,0	-	R1/8"	FLZ204	UC202G2	12,80	6,65	0,5		15
-	22,0	6,0	24,6	-	R1/8"	FLZ203	US202G2	9,55	4,78	0,4		
-	28,6	6,5	-	28,6	R1/8"	FLZ203	ES202G2	9,55	4,78	0,4		
-	43,5	17,0	-	33,3	R1/8"	FLZ204	EX202G2	12,80	6,65	0,6		
-	31,0	12,7	29,0	-	R1/8"	FLZ204	UC203G2	12,80	6,65	0,5		17
-	22,0	6,0	24,6	-	R1/8"	FLZ203	US203G2	9,55	4,78	0,4		
-	28,6	6,5	-	28,6	R1/8"	FLZ203	ES203G2	9,55	4,78	0,4		
-	43,5	17,0	-	33,3	R1/8"	FLZ204	EX203G2	12,80	6,65	0,6		
-	31,0	12,7	29,0	-	R1/8"	FLZ204	UC204G2	12,80	6,65	0,5		20
-	25,0	7,0	29,0	-	R1/8"	FLZ204	US204G2	12,80	6,65	0,4		
-	30,9	7,5	-	33,3	R1/8"	FLZ204	ES204G2	12,80	6,65	0,5		
-	43,5	17,0	-	33,3	R1/8"	FLZ204	EX204G2	12,80	6,65	0,5		
35,0	-	-	-	38,0	R1/8"	FLZ205	UK205G2H	14,00	7,88	0,7		
-	34,0	14,3	34,0	-	R1/8"	FLZ205	UC205G2	14,00	7,88	0,7		25
-	27,0	7,5	34,0	-	R1/8"	FLZ205	US205G2	14,00	7,88	0,6		
-	30,9	7,5	-	38,1	R1/8"	FLZ205	ES205G2	14,00	7,88	0,7		
-	44,3	17,4	-	38,1	R1/8"	FLZ205	EX205G2	14,00	7,88	0,7		
38,0	-	-	-	45,0	R1/8"	FLZ206	UK206G2H	19,50	11,20	1,0		
-	38,1	15,9	40,3	-	R1/8"	FLZ206	UC206G2	19,50	11,20	0,9		
-	30,0	8,0	40,3	-	R1/8"	FLZ206	US206G2	19,50	11,20	0,9		
-	35,7	9,0	-	44,5	R1/8"	FLZ206	ES206G2	19,50	11,20	0,9		
-	48,3	18,2	-	44,5	R1/8"	FLZ206	EX206G2	19,50	11,20	1,0		
43,0	-	-	-	52,0	R1/8"	FLZ207	UK207G2H	25,70	15,20	1,2		
-	42,9	17,5	48,0	-	R1/8"	FLZ207	UC207G2	25,70	15,20	1,2		35
-	32,0	8,5	48,0	-	R1/8"	FLZ207	US207G2	25,70	15,20	1,1		
-	38,9	9,5	-	55,6	R1/8"	FLZ207	ES207G2	25,70	15,20	1,2		
-	51,1	18,8	-	55,6	R1/8"	FLZ207	EX207G2	25,70	15,20	1,3		
46,0	-	-	-	58,0	R1/8"	FLZ208	UK208G2H	29,60	18,20	1,7		



→ Two-bolt piloted flange unit

FLZ200

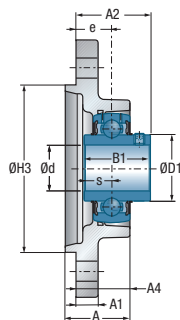
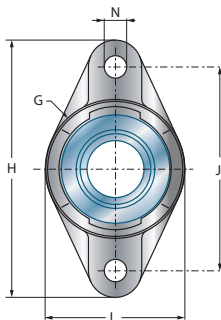
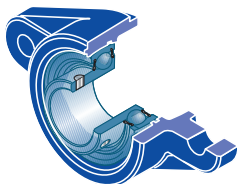

UCFLZ200

Shaft diameter		Unit		Main dimensions [mm]								
d mm		L	H	J	A	A1	A2	A4	H3 h8	e	N	s1
40	UCFLZ208	105,0	172,0	143,5	36,0	13,0	50,2	32,0	100	20	14,0	-
	USFLZ208	105,0	172,0	143,5	36,0	13,0	45,0	32,0	100	20	14,0	-
	ESFLZ208	105,0	172,0	143,5	36,0	13,0	52,7	32,0	100	20	14,0	-
	EXFLZ208	105,0	172,0	143,5	36,0	13,0	54,9	32,0	100	20	14,0	-
	UKFLZ209H	111,0	180,0	148,5	36,5	13,0	46,0	32,5	105	20	14,0	26,0
45	UCFLZ209	111,0	180,0	148,5	36,5	13,0	50,2	32,5	105	20	14,0	-
	USFLZ209	111,0	180,0	148,5	36,5	13,0	51,0	32,5	105	20	14,0	-
	ESFLZ209	111,0	180,0	148,5	36,5	13,0	52,7	32,5	105	20	14,0	-
	EXFLZ209	111,0	180,0	148,5	36,5	13,0	54,9	32,5	105	20	14,0	-
	UKFLZ210H	116,0	190,0	157,0	41,0	13,0	51,5	37,0	105	24	14,0	27,5
50	UCFLZ210	116,0	190,0	157,0	41,0	13,0	56,6	37,0	105	24	14,0	-
	USFLZ210	116,0	190,0	157,0	41,0	13,0	56,6	37,0	105	24	14,0	-
	ESFLZ210	116,0	190,0	157,0	41,0	13,0	56,7	37,0	105	24	14,0	-
	EXFLZ210	116,0	190,0	157,0	41,0	13,0	62,1	37,0	105	24	14,0	-
55	UKFLZ212H	138,0	238,0	202,0	49,0	16,0	61,0	45,0	130	30	18,0	31,0
60	UCFLZ212	138,0	238,0	202,0	49,0	16,0	69,7	45,0	130	30	18,0	-
	USFLZ212	138,0	238,0	202,0	49,0	16,0	68,8	45,0	130	30	18,0	-
	ESFLZ212	138,0	238,0	202,0	49,0	16,0	67,3	45,0	130	30	18,0	-
	EXFLZ212	138,0	238,0	202,0	49,0	16,0	76,8	45,0	130	30	18,0	-

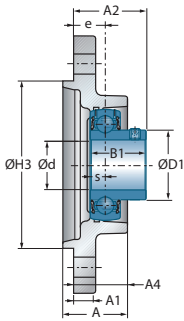

USFLZ200

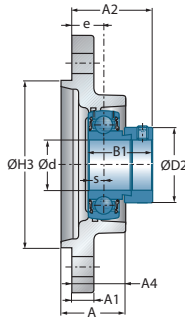

ESFLZ200

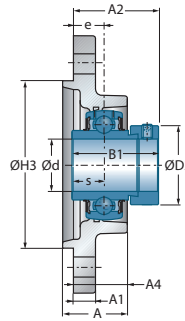

EXFLZ200

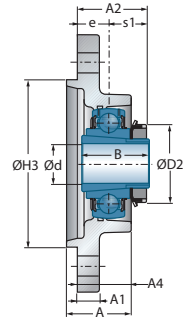

UKFLZ200H

Main dimensions [mm]

Main dimensions [mm]						Housing	Bearing insert	Dynamic load rating	Static load rating	Weight	Shaft diameter
B	B1	s	D1	D2	G			C_r [kN]	C_{0r} [kN]	kg	d mm
-	49,2	19,0	53,0	-	R1/8"	FLZ208	UC208G2	29,60	18,20	1,6	40
-	34,0	9,0	53,0	-	R1/8"	FLZ208	US208G2	29,60	18,20	1,6	
-	43,7	11,0	-	60,3	R1/8"	FLZ208	ES208G2	29,60	18,20	1,6	
-	56,3	21,4	-	60,3	R1/8"	FLZ208	EX208G2	29,60	18,20	1,8	
50,0	-	-	-	65,0	R1/8"	FLZ209	UK209G2H	31,85	20,80	1,9	
-	49,2	19,0	57,2	-	R1/8"	FLZ209	UC209G2	31,85	20,80	1,8	45
-	41,2	10,2	57,2	-	R1/8"	FLZ209	US209G2	31,85	20,80	1,8	
-	43,7	11,0	-	63,5	R1/8"	FLZ209	ES209G2	31,85	20,80	1,8	
-	56,3	21,4	-	63,5	R1/8"	FLZ209	EX209G2	31,85	20,80	2,0	
55,0	-	-	-	70,0	R1/8"	FLZ210	UK210G2H	35,10	23,20	2,3	
-	51,6	19,0	61,8	-	R1/8"	FLZ210	UC210G2	35,10	23,20	2,2	50
-	43,5	10,9	61,8	-	R1/8"	FLZ210	US210G2	35,10	23,20	2,1	
-	43,7	11,0	-	69,9	R1/8"	FLZ210	ES210G2	35,10	23,20	2,2	
-	62,7	24,6	-	69,9	R1/8"	FLZ210	EX210G2	35,10	23,20	2,4	
62,0	-	-	-	80,0	R1/8"	FLZ212	UK212G2H	52,50	32,80	3,5	55
-	65,1	25,4	74,9	-	R1/8"	FLZ212	UC212G2	52,50	32,80	3,5	60
-	53,7	14,9	74,9	-	R1/8"	FLZ212	US212G2	52,50	32,80	3,3	
-	49,3	12,0	-	84,2	R1/8"	FLZ212	ES212G2	52,50	32,80	3,2	
-	77,7	30,9	-	84,2	R1/8"	FLZ212	EX212G2	52,50	32,80	3,9	



→ Two-bolt flanged unit

FD200

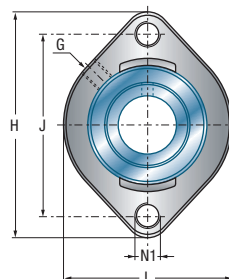
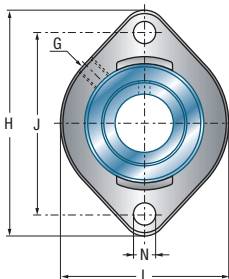
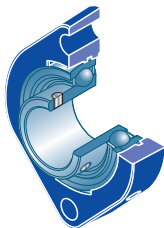

Shaft diameter		Unit		Main dimensions [mm]							
d mm		L	H	J	A	A2	e	N1*	N	B1	
12	USFD201	58,7	81,0	63,5	15,0	24,4	8,4	M6	6,5	22,0	
	ESFD201	58,7	81,0	63,5	15,0	30,5	8,4	M6	6,5	28,6	
15	USFD202	58,7	81,0	63,5	15,0	24,4	8,4	M6	6,5	22,0	
	ESFD202	58,7	81,0	63,5	15,0	30,5	8,4	M6	6,5	28,6	
17	USFD203	58,7	81,0	63,5	15,0	24,4	8,4	M6	6,5	22,0	
	ESFD203	58,7	81,0	63,5	15,0	30,5	8,4	M6	6,5	28,6	
20	USFD204	66,5	90,5	71,4	17,0	27,5	9,5	M10	9,0	25,0	
	ESFD204	66,5	90,5	71,4	17,0	32,9	9,5	M10	9,0	30,9	
25	USFD205	71,0	97,0	76,2	17,5	29,4	9,9	M12	9,0	27,0	
	ESFD205	71,0	97,0	76,2	17,5	33,3	9,9	M12	9,0	30,9	
30	USFD206	84,0	112,5	90,5	20,5	33,4	11,4	M12	11,0	30,0	
	ESFD206	84,0	112,5	90,5	20,5	38,1	11,4	M12	11,0	35,7	
35	USFD207	94,0	126,0	100,0	22,0	35,9	12,4	M12	11,0	32,0	
	ESFD207	94,0	126,0	100,0	22,0	41,8	12,4	M12	11,0	38,9	
40	USFD208	104,0	148,0	119,0	24,0	37,1	12,05	M12	14,0	34,0	
	ESFD208	104,0	148,0	119,0	24,0	44,8	12,05	M12	14,0	43,7	

* Type code for the execution with mounting thread : e.g. : USFD204M10

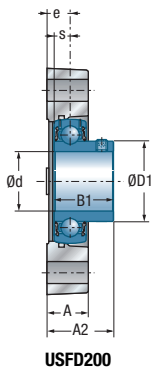

USFD200

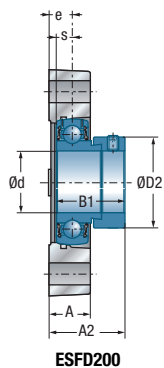

ESFD200

Main dimensions [mm]

Main dimensions [mm]				Housing	Bearing insert	Dynamic load rating	Static load rating	Weight	Shaft diameter
s	D1	D2	G			C_r [kN]	C_{0r} [kN]	kg	d mm
6,0	24,6	-	M6x1	FD203	US201G2	9,55	4,78	0,3	12
6,5	-	28,6	M6x1	FD203	ES201G2	9,55	4,78	0,3	
6,0	24,6	-	M6x1	FD203	US202G2	9,55	4,78	0,3	14
6,5	-	28,6	M6x1	FD203	ES202G2	9,55	4,78	0,3	
6,0	24,6	-	M6x1	FD203	US203G2	9,55	4,78	0,3	17
6,5	-	28,6	M6x1	FD203	ES203G2	9,55	4,78	0,3	
7,0	29,0	-	M6x1	FD204	US204G2	12,80	6,65	0,4	20
7,5	-	33,3	M6x1	FD204	ES204G2	12,80	6,65	0,4	
7,5	34,0	-	M6x1	FD205	US205G2	14,00	7,88	0,5	25
7,5	-	38,1	M6x1	FD205	ES205G2	14,00	7,88	0,5	
8,0	40,3	-	R1/8"	FD206	US206G2	19,50	11,20	0,7	30
9,0	-	44,5	R1/8"	FD206	ES206G2	19,50	11,20	0,7	
8,5	48,0	-	R1/8"	FD207	US207G2	25,70	15,20	1,0	35
9,5	-	55,6	R1/8"	FD207	ES207G2	25,70	15,20	1,0	
9,0	53,0	-	R1/8"	FD208	US208G2	29,60	18,20	1,3	40
11,0	-	60,3	R1/8"	FD208	ES208G2	29,60	18,20	1,3	



→ Adjustable two-bolt flanged unit

FAE200

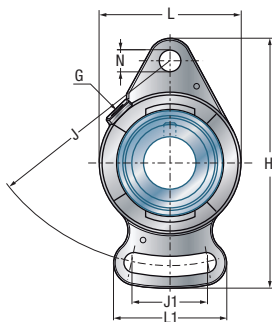
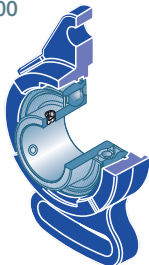

Shaft diameter		Unit		Main dimensions [mm]									
d mm		L	H	J	J1	A	A1	A2	L1	w +0,2	H3 +0,2	e	N
20	USFAE204	61	112	90	30,0	20,0	10,0	28,5	52	2,0	50,8	10,5	11,5
	ESFAE204	61	112	90	30,0	20,0	10,0	33,9	52	2,0	50,8	10,5	11,5
25	USFAE205	70	124	99	37,5	22,5	11,0	32,0	63	3,5	63,5	12,5	11,5
	ESFAE205	70	124	99	37,5	22,5	11,0	35,9	63	3,5	63,5	12,5	11,5
30	USFAE206	80	142	117	40,0	24,0	12,0	35,0	65	3,0	73,0	13,0	11,5
	ESFAE206	80	142	117	40,0	24,0	12,0	39,7	65	3,0	73,0	13,0	11,5
35	USFAE207	90	155	128	45,0	26,5	12,5	38,5	75	4,5	82,5	15,0	14,0
	ESFAE207	90	155	128	45,0	26,5	12,5	44,4	75	4,5	82,5	15,0	14,0

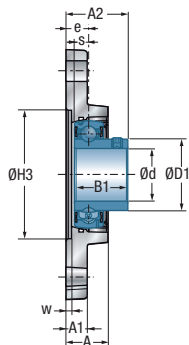

USFAE200

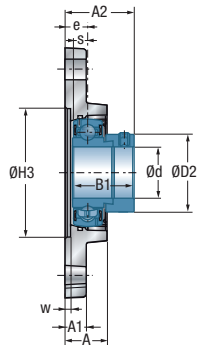

ESFAE200

Main dimensions [mm]

					Housing	Bearing insert	Dynamic load rating	Static load rating	Weight	Shaft diameter
B1	s	D1	D2	G			C_r [kN]	C_{0r} [kN]	kg	d mm
25,0	7,0	29,0	-	R1/8"	FAE204	US204G2	12,80	6,65	0,4	20
30,9	7,5	-	33,3	R1/8"	FAE204	ES204G2	12,80	6,65	0,5	
27,0	7,5	34,0	-	R1/8"	FAE205	US205G2	14,00	7,88	0,5	25
30,9	7,5	-	38,1	R1/8"	FAE205	ES205G2	14,00	7,88	0,5	
30,0	8,0	40,3	-	R1/8"	FAE206	US206G2	19,50	11,20	0,8	30
35,7	9,0	-	44,5	R1/8"	FAE206	ES206G2	19,50	11,20	0,8	
32,0	8,5	48,0	-	R1/8"	FAE207	US207G2	25,70	15,20	1,1	35
38,9	9,5	-	55,6	R1/8"	FAE207	ES207G2	25,70	15,20	1,2	



→ Adjustable two bolt flanged unit

FA200

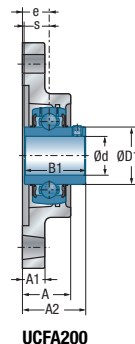
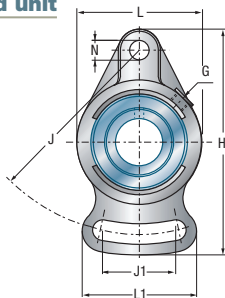
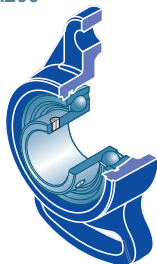

UCFA200

Shaft diameter		Unit		Main dimensions [mm]												
d mm		L	H	J	J1	A	A1	A2	L1	e	N	s1	B	B1	s	
12	UCFA201	60	102	78	40	25,5	12	33,3	54	15	10	-	-	31,0	12,7	
	USFA201	57	95	75	37	22,0	9	29,0	47	13	10	-	-	22,0	6,0	
	ESFA201	57	95	75	37	22,0	9	35,1	47	13	10	-	-	28,6	6,5	
	EXFA201	60	102	78	40	25,5	12	41,5	54	15	10	-	-	43,5	17,0	
15	UCFA202	60	102	78	40	25,5	12	33,3	54	15	10	-	-	31,0	12,7	
	USFA202	57	95	75	37	22,0	9	29,0	47	13	10	-	-	22,0	6,0	
	ESFA202	57	95	75	37	22,0	9	35,1	47	13	10	-	-	28,6	6,5	
	EXFA202	60	102	78	40	25,5	12	41,5	54	15	10	-	-	43,5	17,0	
17	UCFA203	60	102	78	40	25,5	12	33,3	54	15	10	-	-	31,0	12,7	
	USFA203	57	95	75	37	22,0	9	29,0	47	13	10	-	-	22,0	6,0	
	ESFA203	57	95	75	37	22,0	9	35,1	47	13	10	-	-	28,6	6,5	
	EXFA203	60	102	78	40	25,5	12	41,5	54	15	10	-	-	43,5	17,0	
20	UCFA204	60	102	78	40	25,5	12	33,3	54	15	10	-	-	31,0	12,7	
	USFA204	60	102	78	40	25,5	12	33,0	54	15	10	-	-	25,0	7,0	
	ESFA204	60	102	78	40	25,5	12	38,4	54	15	10	-	-	30,9	7,5	
	EXFA204	60	102	78	40	25,5	12	41,5	54	15	10	-	-	43,5	17,0	
	UKFA205H	68	125	98	51	27,0	14	34,5	65	16	12	18,5	35,0	-	-	
25	UCFA205	68	125	98	51	27,0	14	35,7	65	16	12	-	-	34,0	14,3	
	USFA205	68	125	98	51	27,0	14	35,5	65	16	12	-	-	27,0	7,5	
	ESFA205	68	125	98	51	27,0	14	39,4	65	16	12	-	-	30,9	7,5	
	EXFA205	68	125	98	51	27,0	14	42,9	65	16	12	-	-	44,3	17,4	
	UKFA206H	80	144	117	58	31,0	14	38,5	72	18	12	20,5	38,0	-	-	
30	UCFA206	80	144	117	58	31,0	14	40,2	72	18	12	-	-	38,1	15,9	
	USFA206	80	144	117	58	31,0	14	40,0	72	18	12	-	-	30,0	8,0	
	ESFA206	80	144	117	58	31,0	14	44,7	72	18	12	-	-	35,7	9,0	
	EXFA206	80	144	117	58	31,0	14	48,1	72	18	12	-	-	48,3	18,2	
	UKFA207H	90	161	130	66	34,0	16	41,5	82	19	15	22,5	43,0	-	-	
35	UCFA207	90	161	130	66	34,0	16	44,4	82	19	15	-	-	42,9	17,5	
	USFA207	90	161	130	66	34,0	16	42,5	82	19	15	-	-	32,0	8,5	
	ESFA207	90	161	130	66	34,0	16	48,4	82	19	15	-	-	38,9	9,5	
	EXFA207	90	161	130	66	34,0	16	51,3	82	19	15	-	-	51,1	18,8	
	UKFA208H	100	175	144	71	36,0	16	45,5	87	21	15	24,5	46,0	-	-	

* = equipped with one open protective cap for passing shafts; suffix CO or COE
 ** = equipped with one closed protective cap for shaft ends; suffix CC or CCE

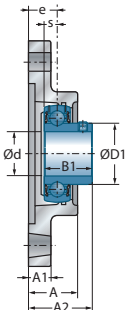

USFA200

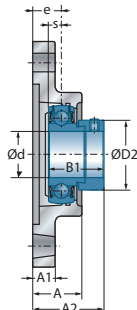

ESFA200

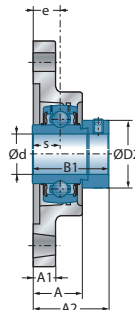

EXFA200

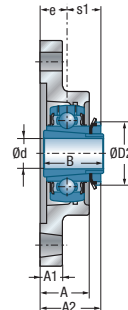

UKFA200H

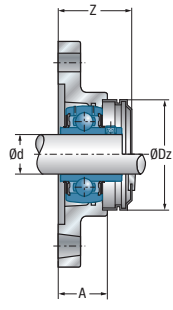

UCFA200CO(CC)

Main dimensions [mm]

Main dimensions [mm]					Housing	Bearing insert	Open protective cap**	Closed protective cap**	Dynamic load rating	Static load rating	Weight	Shaft diameter
D1	D2	G	Z	Dz					C_r [kN]	C_{Or} [kN]	kg	d mm
29,0	-	M6x1	36,5	54,0	FA204	UC201G2	CO	CC	12,80	6,65	0,5	12
24,6	-	M6x1	33,0	46,0	FA203	US201G2	CO	CC	9,55	4,78	0,4	
-	28,6	M6x1	39,7	46,0	FA203	ES201G2	COE	CCE	9,55	4,78	0,5	
-	33,3	M6x1	45,7	54,0	FA204	EX201G2	COE	CCE	12,80	6,65	0,6	
29,0	-	M6x1	36,5	54,0	FA204	UC202G2	CO	CC	12,80	6,65	0,6	15
24,6	-	M6x1	33,0	46,0	FA203	US202G2	CO	CC	9,55	4,78	0,4	
-	28,6	M6x1	39,7	46,0	FA203	ES202G2	COE	CCE	9,55	4,78	0,5	
-	33,3	M6x1	45,7	54,0	FA204	EX202G2	COE	CCE	12,80	6,65	0,6	
29,0	-	M6x1	33,0	54,0	FA204	UC203G2	CO	CC	12,80	6,65	0,5	17
24,6	-	M6x1	33,0	46,0	FA203	US203G2	CO	CC	9,55	4,78	0,5	
-	28,6	M6x1	39,7	46,0	FA203	ES203G2	COE	CCE	9,55	4,78	0,5	
-	33,3	M6x1	45,7	54,0	FA204	EX203G2	COE	CCE	12,80	6,65	0,6	
29,0	-	M6x1	36,5	54,0	FA204	UC204G2	CO	CC	12,80	6,65	0,5	20
29,0	-	M6x1	36,5	54,0	FA204	US204G2	CO	CC	12,80	6,65	0,5	
-	33,3	M6x1	45,7	54,0	FA204	ES204G2	COE	CCE	12,80	6,65	0,6	
-	33,3	M6x1	45,7	54,0	FA204	EX204G2	COE	CCE	12,80	6,65	0,6	
-	38,0	M6x1	39,1	60,0	FA205	UK205G2H	CO	CC	14,00	7,88	0,7	
34,0	-	M6x1	39,1	60,0	FA205	UC205G2	CO	CC	14,00	7,88	0,7	25
34,0	-	M6x1	39,1	60,0	FA205	US205G2	CO	CC	14,00	7,88	0,7	
-	38,1	M6x1	47,7	60,0	FA205	ES205G2	COE	CCE	14,00	7,88	0,7	
-	38,1	M6x1	47,7	60,0	FA205	EX205G2	COE	CCE	14,00	7,88	0,8	
-	45,0	M6x1	44,1	70,0	FA206	UK206G2H	CO	CC	19,50	11,20	1,2	
40,3	-	M6x1	44,1	70,0	FA206	UC206G2	CO	CC	19,50	11,20	1,2	30
40,3	-	M6x1	44,1	70,0	FA206	US206G2	CO	CC	19,50	11,20	1,1	
-	44,5	M6x1	53,1	70,0	FA206	ES206G2	COE	CCE	19,50	11,20	1,2	
-	44,5	M6x1	53,1	70,0	FA206	EX206G2	COE	CCE	19,50	11,20	1,3	
-	52,0	M6x1	48,3	80,0	FA207	UK207G2H	CO	CC	25,70	15,20	1,6	
48,0	-	M6x1	48,3	80,0	FA207	UC207G2	CO	CC	25,70	15,20	1,6	35
48,0	-	M6x1	48,3	80,0	FA207	US207G2	CO	CC	25,70	15,20	1,5	
-	55,6	M6x1	57,6	80,0	FA207	ES207G2	COE	CCE	25,70	15,20	1,6	
-	55,6	M6x1	57,6	80,0	FA207	EX207G2	COE	CCE	25,70	15,20	1,7	
-	58,0	M6x1	55,1	88,0	FA208	UK208G2H	CO	CC	29,60	18,20	2,1	



→ Adjustable two bolt flanged unit

FA200

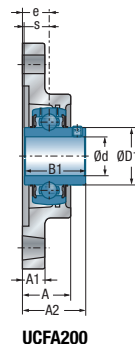
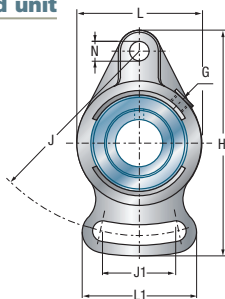
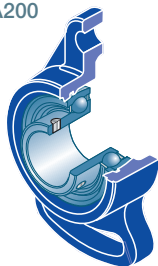

UCFA200

Shaft diameter		Unit		Main dimensions [mm]												
d mm		L	H	J	J1	A	A1	A2	L1	e	N	s1	B	B1	s	
40	UCFA208	100	175	144	71	36,0	16	51,2	87	21	15	-	-	49,2	19,0	
	USFA208	100	175	144	71	36,0	16	46,0	87	21	15	-	-	34,0	9,0	
	ESFA208	100	175	144	71	36,0	16	53,7	87	21	15	-	-	43,7	11,0	
	EXFA208	100	175	144	71	36,0	16	55,9	87	21	15	-	-	56,3	21,4	
	UKFA209H	108	181	148	72	38,0	18	48,0	90	22	15	26,0	50,0	-	-	
45	UCFA209	108	181	148	72	38,0	18	52,2	90	22	15	-	-	49,2	19,0	
	USFA209	108	181	148	72	38,0	18	53,0	90	22	15	-	-	41,2	10,2	
	ESFA209	108	181	148	72	38,0	18	54,7	90	22	15	-	-	43,7	11,0	
	EXFA209	108	181	148	72	38,0	18	56,9	90	22	15	-	-	56,3	21,4	
	UKFA210H	115	190	157	76	40,0	18	49,5	94	22	15	27,5	55,0	-	-	
50	UCFA210	115	190	157	76	40,0	18	54,6	94	22	15	-	-	51,6	19,0	
	USFA210	115	190	157	76	40,0	18	54,6	94	22	15	-	-	43,5	10,9	
	ESFA210	115	190	157	76	40,0	18	54,7	94	22	15	-	-	43,7	11,0	
	EXFA210	115	190	157	76	40,0	18	60,1	94	22	15	-	-	62,7	24,6	
	UKFA211H	130	219	184	86	43,0	20	54,0	104	25	16	29,0	59,0	-	-	
55	UCFA211	130	219	184	86	43,0	20	58,4	104	25	16	-	-	55,6	22,2	
	USFA211	130	219	184	86	43,0	20	58,5	104	25	16	-	-	45,3	11,8	
	ESFA211	130	219	184	86	43,0	20	61,4	104	25	16	-	-	48,4	12,0	
	EXFA211	130	219	184	86	43,0	20	68,6	104	25	16	-	-	71,3	27,7	
	UKFA212H	140	250	202	92	48,0	20	60,0	118	29	23	31,0	62,0	-	-	
60	UCFA212	140	250	202	92	48,0	20	68,7	118	29	23	-	-	65,1	25,4	
	USFA212	140	250	202	92	48,0	20	67,8	118	29	23	-	-	53,7	14,9	
	ESFA212	140	250	202	92	48,0	20	66,3	118	29	23	-	-	49,3	12,0	
	EXFA212	140	250	202	92	48,0	20	75,8	118	29	23	-	-	77,7	30,9	

* = equipped with one open protective cap for passing shafts; suffix CO or COE
 ** = equipped with one closed protective cap for shaft ends; suffix CC or CCE

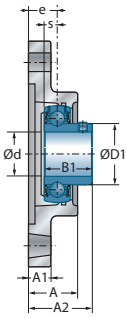

USFA200

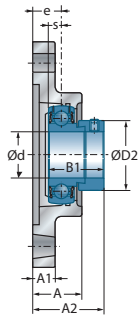

ESFA200

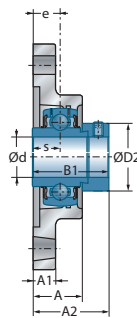

EXFA200

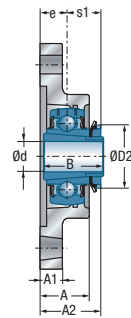

UKFA200H

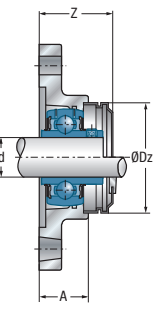

UCFA200CO(CC)

Main dimensions [mm]

Main dimensions [mm]					Housing	Bearing insert	Open protective cap**	Closed protective cap**	Dynamic load rating	Static load rating	Weight	Shaft diameter
D1	D2	G	Z	Dz					C_r [kN]	C_{0r} [kN]	kg	d mm
53,0	-	M6x1	55,1	88,0	FA208	UC208G2	CO	CC	29,60	18,20	2,0	40
53,0	-	M6x1	55,1	88,0	FA208	US208G2	CO	CC	29,60	18,20	2,0	
-	60,3	M6x1	61,2	88,0	FA208	ES208G2	COE	CCE	29,60	18,20	2,0	
-	60,3	M6x1	61,2	88,0	FA208	EX208G2	COE	CCE	29,60	18,20	2,1	
-	65,0	M6x1	56,3	95,0	FA209	UK209G2H	CO	CC	31,85	20,80	2,4	
57,2	-	M6x1	56,3	95,0	FA209	UC209G2	CO	CC	31,85	20,80	2,3	45
57,2	-	M6x1	56,3	95,0	FA209	US209G2	CO	CC	31,85	20,80	2,3	
-	63,5	M6x1	63,4	95,0	FA209	ES209G2	COE	CCE	31,85	20,80	2,3	
-	63,5	M6x1	63,4	95,0	FA209	EX209G2	COE	CCE	31,85	20,80	2,5	
-	70,0	M6x1	59,3	100,0	FA210	UK210G2H	CO	CC	35,10	23,20	2,9	
61,8	-	M6x1	59,3	100,0	FA210	UC210G2	CO	CC	35,10	23,20	2,7	50
61,8	-	M6x1	59,3	100,0	FA210	US210G2	CO	CC	35,10	23,20	2,7	
-	69,9	M6x1	67,0	100,0	FA210	ES210G2	COE	CCE	35,10	23,20	2,7	
-	69,9	M6x1	67,0	100,0	FA210	EX210G2	COE	CCE	35,10	23,20	2,9	
-	75,0	M6x1	62,8	110,0	FA211	UK211G2H	CO	CC	43,55	29,20	3,6	
69,0	-	M6x1	62,8	110,0	FA211	UC211G2	CO	CC	43,55	29,20	3,5	55
69,0	-	M6x1	62,8	110,0	FA211	US211G2	CO	CC	43,55	29,20	3,5	
-	76,2	M6x1	76,2	110,0	FA211	ES211G2	COE	CCE	43,55	29,20	3,3	
-	76,2	M6x1	76,2	110,0	FA211	EX211G2	COE	CCE	43,55	29,20	3,8	
-	80,0	M6x1	73,3	120,0	FA212	UK212G2H	CO	CC	52,50	32,80	4,2	
74,9	-	M6x1	73,3	120,0	FA212	UC212G2	CO	CC	52,50	32,80	4,2	60
74,9	-	M6x1	73,3	120,0	FA212	US212G2	CO	CC	52,50	32,80	4,0	
-	84,2	M6x1	83,9	120,0	FA212	ES212G2	COE	CCE	52,50	32,80	3,9	
-	84,2	M6x1	83,9	120,0	FA212	EX212G2	COE	CCE	52,50	32,80	4,6	



→ Take-up unit

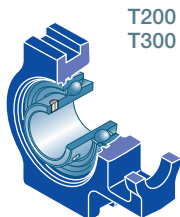

T200
T300

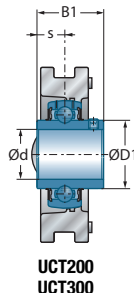
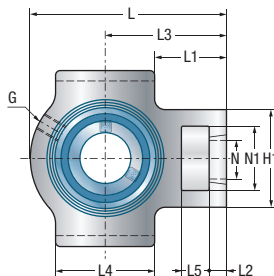
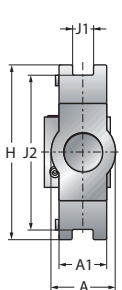

UCT200
UCT300

Shaft diameter		Unit		Main dimensions [mm]																		
d mm		L	H	J1	J2	A	A1	L1	L2	L3	L4	L5	H1	N	N1	s1	B	B1	s			
12	UCT201	94	89	12	76	32	21	35,5	10	61	51	16	51	19	32	-	-	31,0	12,7			
	EXT201	94	89	12	76	32	21	35,5	10	61	51	16	51	19	32	-	-	43,5	17,0			
15	UCT202	94	89	12	76	32	21	35,5	10	61	51	16	51	19	32	-	-	31,0	12,7			
	EXT202	94	89	12	76	32	21	35,5	10	61	51	16	51	19	32	-	-	43,5	17,0			
17	UCT203	94	89	12	76	32	21	35,5	10	61	51	16	51	19	32	-	-	31,0	12,7			
	EXT203	94	89	12	76	32	21	35,5	10	61	51	16	51	19	32	-	-	43,5	17,0			
20	UCT204	94	89	12	76	32	21	35,5	10	61	51	16	51	19	32	-	-	31,0	12,7			
	UST204	94	89	12	76	32	21	35,5	10	61	51	16	51	19	32	-	-	25,0	7,0			
	EST204	94	89	12	76	32	21	35,5	10	61	51	16	51	19	32	-	-	30,9	7,5			
	EXT204	94	89	12	76	32	21	35,5	10	61	51	16	51	19	32	-	-	43,5	17,0			
	UKT205H	97	89	12	76	32	24	36,5	10	62	51	16	51	19	32	18,5	35	-	-			
	UKT305H	122	89	12	80	36	26	43,5	14	76	65	16	62	26	36	21,5	35	-	-			
25	UCT205	97	89	12	76	32	24	36,5	10	62	51	16	51	19	32	-	-	34,0	14,3			
	UST205	97	89	12	76	32	24	36,5	10	62	51	16	51	19	32	-	-	27,0	7,5			
	EST205	97	89	12	76	32	24	36,5	10	62	51	16	51	19	32	-	-	30,9	7,5			
	EXT205	97	89	12	76	32	24	36,5	10	62	51	16	51	19	32	-	-	44,3	17,4			
	UKT206H	113	102	12	89	37	28	41,5	10	70	57	16	56	22	37	20,5	38	-	-			
	UCT305	122	89	12	80	36	26	43,5	14	76	65	16	62	26	36	-	-	38,0	15,0			
	EXT305	122	89	12	80	36	26	43,5	14	76	65	16	62	26	36	-	-	46,8	16,7			
	UKT306H	137	100	16	90	41	28	48,0	16	85	74	18	70	28	41	23,0	38	-	-			
30	UCT206	113	102	12	89	37	28	41,5	10	70	57	16	56	22	37	-	-	38,1	15,9			
	UST206	113	102	12	89	37	28	41,5	10	70	57	16	56	22	37	-	-	30,0	8,0			
	EST206	113	102	12	89	37	28	41,5	10	70	57	16	56	22	37	-	-	35,7	9,0			
	EXT206	113	102	12	89	37	28	41,5	10	70	57	16	56	22	37	-	-	48,3	18,2			
	UKT207H	129	102	12	89	37	30	46,0	13	78	64	16	64	22	37	22,5	43	-	-			
	UCT306	137	100	16	90	41	28	48,0	16	85	74	18	70	28	41	-	-	43,0	17,0			
	EXT306	137	100	16	90	41	28	48,0	16	85	74	18	70	28	41	-	-	50,0	17,5			
	UKT307H	150	111	16	100	45	32	54,0	17	94	80	20	75	30	45	25,5	43	-	-			

* = equipped with two open protective caps for passing shafts; suffix CO or COE
 ** = equipped with one open and one closed protective cap for shaft ends; suffix CC or CCE

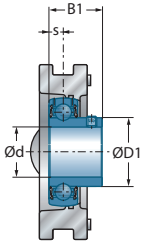

UST200

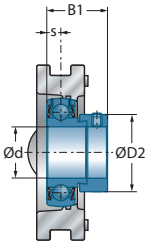

EST200

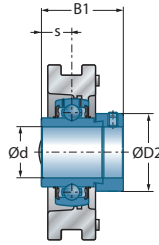

EXT200
EXT300

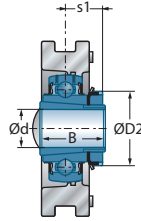

UKT200H
UKT300H

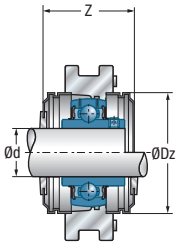

UCT200C0(C)

Main dimensions [mm]

Main dimensions [mm]					Housing	Bearing insert	Open protective cap**	Closed protective cap**	Dynamic load rating	Static load rating	Weight	Shaft diameter
D1	D2	G	Z	Dz					C_r [kN]	C_{Or} [kN]	kg	d mm
29,0	-	M6x1	43,7	54,0	T204	UC201G2	CO	CC	12,80	6,65	0,8	12
-	33,3	M6x1	57,1	54,0	T204	EX201G2	COE	CCE	12,80	6,65	0,9	
29,0	-	M6x1	43,7	54,0	T204	UC202G2	CO	CC	12,80	6,65	0,8	15
-	33,3	M6x1	57,1	54,0	T204	EX202G2	COE	CCE	12,80	6,65	0,8	
29,0	-	M6x1	43,7	54,0	T204	UC203G2	CO	CC	12,80	6,65	0,7	17
-	33,3	M6x1	57,1	54,0	T204	EX203G2	COE	CCE	12,80	6,65	0,8	
29,0	-	M6x1	43,7	54,0	T204	UC204G2	CO	CC	12,80	6,65	0,7	20
29,0	-	M6x1	43,7	54,0	T204	US204G2	CO	CC	12,80	6,65	0,7	
-	33,3	M6x1	62,1	54,0	T204	ES204G2	COE	CCE	12,80	6,65	0,7	
-	33,3	M6x1	62,1	54,0	T204	EX204G2	COE	CCE	12,80	6,65	0,8	
-	38,0	M6x1	47,5	60,0	T205	UK205G2H	CO	CC	14,00	7,88	0,8	
-	38,0	M6x1	-	-	T305	UK305G2H	-	-	22,36	11,50	1,4	
34,0	-	M6x1	47,5	60,0	T205	UC205G2	CO	CC	14,00	7,88	0,8	25
34,0	-	M6x1	47,5	60,0	T205	US205G2	CO	CC	14,00	7,88	0,8	
-	38,1	M6x1	64,7	60,0	T205	ES205G2	COE	CCE	14,00	7,88	0,8	
-	38,1	M6x1	64,7	60,0	T205	EX205G2	COE	CCE	14,00	7,88	0,9	
-	45,0	M6x1	52,5	70,0	T206	UK206G2H	CO	CC	19,50	11,20	1,3	
35,4	-	M6x1	-	-	T305	UC305G2	-	-	22,36	11,50	1,3	
-	42,8	M6x1	-	-	T305	EX305G2	-	-	22,36	11,50	1,3	
-	45,0	M6x1	-	-	T306	UK306G2H	-	-	27,00	15,20	1,8	
40,3	-	M6x1	52,5	70,0	T206	UC206G2	CO	CC	19,50	11,20	1,2	30
40,3	-	M6x1	52,5	70,0	T206	US206G2	CO	CC	19,50	11,20	1,2	
-	44,5	M6x1	70,7	70,0	T206	ES206G2	COE	CCE	19,50	11,20	1,2	
-	44,5	M6x1	70,7	70,0	T206	EX206G2	COE	CCE	19,50	11,20	1,3	
-	52,0	M6x1	59,1	80,0	T207	UK207G2H	CO	CC	25,70	15,20	1,6	
44,6	-	M6x1	-	-	T306	UC306G2	-	-	27,00	15,20	1,8	
-	50,0	M6x1	-	-	T306	EX306G2	-	-	27,00	15,20	1,9	
-	52,0	M6x1	-	-	T307	UK307G2H	-	-	33,50	19,20	2,5	

→ Take-up unit

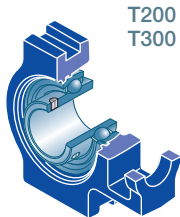

T200
T300

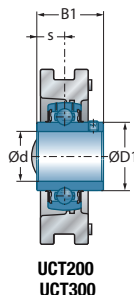
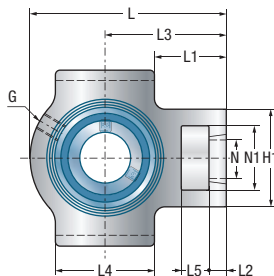
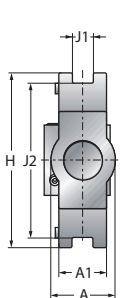

UCT200
UCT300

Shaft diameter		Unit		Main dimensions [mm]																			
d mm		L	H	J1	J2	A	A1	L1	L2	L3	L4	L5	H1	N	N1	s1	B	B1	s				
35	UCT207	129	102	12	89	37	30	46,0	13	78	64	16	64	22	37	-	-	42,9	17,5				
	UST207	129	102	12	89	37	30	46,0	13	78	64	16	64	22	37	-	-	32,0	8,5				
	EST207	129	102	12	89	37	30	46,0	13	78	64	16	64	22	37	-	-	38,9	9,5				
	EXT207	129	102	12	89	37	30	46,0	13	78	64	16	64	22	37	-	-	51,1	18,8				
	UKT208H	144	114	16	102	49	33	46,5	16	88	83	19	83	29	49	24,5	46	-	-				
	UCT307	150	111	16	100	45	32	54,0	17	94	80	20	75	30	45	-	-	48,0	19,0				
	EXT307	150	111	16	100	45	32	54,0	17	94	80	20	75	30	45	-	-	51,6	18,3				
	UKT308H	162	124	18	112	50	34	55,5	19	100	89	22	83	32	50	27,5	46	-	-				
40	UCT208	144	114	16	102	49	33	46,5	16	88	83	19	83	29	49	-	-	49,2	19,0				
	UST208	144	114	16	102	49	33	46,5	16	88	83	19	83	29	49	-	-	34,0	9,0				
	EST208	144	114	16	102	49	33	46,5	16	88	83	19	83	29	49	-	-	43,7	11,0				
	EXT208	144	114	16	102	49	33	46,5	16	88	83	19	83	29	49	-	-	56,3	21,4				
	UKT209H	144	117	16	102	49	35	45,5	16	87	83	19	83	29	49	26,0	50	-	-				
	UCT308	162	124	18	112	50	34	55,5	19	100	89	22	83	32	50	-	-	52,0	19,0				
	EXT308	162	124	18	112	50	34	55,5	19	100	89	22	83	32	50	-	-	57,1	19,8				
	UKT309H	178	138	18	125	55	38	61,5	20	110	97	24	90	34	55	30,0	50	-	-				
45	UCT209	144	117	16	102	49	35	45,5	16	87	83	19	83	29	49	-	-	49,2	19,0				
	UST209	144	117	16	102	49	35	45,5	16	87	83	19	83	29	49	-	-	41,2	10,2				
	EST209	144	117	16	102	49	35	45,5	16	87	83	19	83	29	49	-	-	43,7	11,0				
	EXT209	144	117	16	102	49	35	45,5	16	87	83	19	83	29	49	-	-	56,3	21,4				
	UKT210H	149	117	16	102	49	37	47,0	16	90	86	19	83	29	49	27,5	55	-	-				
	UCT309	178	138	18	125	55	38	61,5	20	110	97	24	90	34	55	-	-	57,0	22,0				
	EXT309	178	138	18	125	55	38	61,5	20	110	97	24	90	34	55	-	-	58,7	19,8				
	UKT310H	192	151	20	140	61	40	65,0	22	118	106	27	98	37	61	32,0	55	-	-				
50	UCT210	149	117	16	102	49	37	47,0	16	90	86	19	83	29	49	-	-	51,6	19,0				
	UST210	149	117	16	102	49	37	47,0	16	90	86	19	83	29	49	-	-	43,5	10,9				
	EST210	149	117	16	102	49	37	47,0	16	90	86	19	83	29	49	-	-	43,7	11,0				
	EXT210	149	117	16	102	49	37	47,0	16	90	86	19	83	29	49	-	-	62,7	24,6				
	UKT211H	171	146	22	130	64	38	58,5	19	106	95	25	102	35	64	29,0	59	-	-				
	UCT310	192	151	20	140	61	40	65,0	22	118	106	27	98	37	61	-	-	61,0	22,0				
	EXT310	192	151	20	140	61	40	65,0	22	118	106	27	98	37	61	-	-	66,6	24,6				
	UKT311H	207	163	22	150	66	44	69,5	23	127	115	29	105	39	66	34,0	59	-	-				

* = equipped with two open protective caps for passing shafts; suffix CO or COE
 ** = equipped with one open and one closed protective cap for shaft ends; suffix CC or CCE

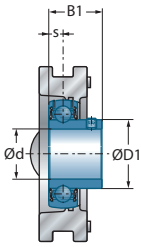

UST200

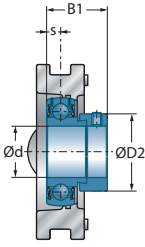

EST200

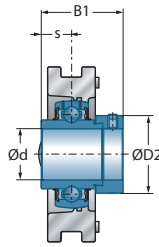

EXT200
EXT300

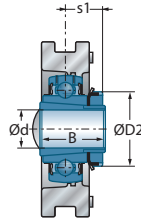

UKT200H
UKT300H

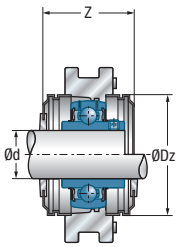

UCT200CO(CC)

Main dimensions [mm]

Main dimensions [mm]					Housing	Bearing insert	Open protective cap**	Closed protective cap**	Dynamic load rating	Static load rating	Weight	Shaft diameter
D1	D2	G	Z	Dz					C _r [kN]	C _{0r} [kN]	kg	d mm
48,0	-	M6x1	59,1	80,0	T207	UC207G2	CO	CC	25,70	15,20	1,6	35
48,0	-	M6x1	59,1	80,0	T207	US207G2	CO	CC	25,70	15,20	1,5	
-	55,6	M6x1	77,7	80,0	T207	ES207G2	COE	CCE	25,70	15,20	1,6	
-	55,6	M6x1	77,7	80,0	T207	EX207G2	COE	CCE	25,70	15,20	1,7	
-	58,0	M6x1	68,6	88,0	T208	UK208G2H	CO	CC	29,60	18,20	2,4	
48,9	-	M6x1	-	-	T307	UC307G2	-	-	33,50	19,20	2,3	
-	55,0	M6x1	-	-	T307	EX307G2	-	-	33,50	19,20	2,4	
-	58,0	M6x1	-	-	T308	UK308G2H	-	-	40,56	24,00	3,0	
53,0	-	M6x1	68,6	88,0	T208	UC208G2	CO	CC	29,60	18,20	2,3	40
53,0	-	M6x1	68,6	88,0	T208	US208G2	CO	CC	29,60	18,20	2,3	
-	60,3	M6x1	80,8	88,0	T208	ES208G2	COE	CCE	29,60	18,20	2,3	
-	60,3	M6x1	80,8	88,0	T208	EX208G2	COE	CCE	29,60	18,20	2,5	
-	65,0	M6x1	68,6	95,0	T209	UK209G2H	CO	CC	31,85	20,80	2,5	
56,5	-	M6x1	-	-	T308	UC308G2	-	-	40,56	24,00	3,0	
-	63,5	M6x1	-	-	T308	EX308G2	-	-	40,56	24,00	3,1	
-	65,0	M6x1	-	-	T309	UK309G2H	-	-	53,00	31,80	4,2	
57,2	-	M6x1	68,6	95,0	T209	UC209G2	CO	CC	31,85	20,80	2,3	45
57,2	-	M6x1	68,6	95,0	T209	US209G2	CO	CC	31,85	20,80	2,3	
-	63,5	M6x1	82,8	95,0	T209	ES209G2	COE	CCE	31,85	20,80	2,4	
-	63,5	M6x1	82,8	95,0	T209	EX209G2	COE	CCE	31,85	20,80	2,5	
-	70,0	M6x1	74,1	100,0	T210	UK210G2H	CO	CC	35,10	23,20	2,7	
61,8	-	M6x1	-	-	T309	UC309G2	-	-	53,00	31,80	4,0	
-	70,0	M6x1	-	-	T309	EX309G2	-	-	53,00	31,80	4,2	
-	70,0	M6x1	-	-	T310	UK310G2H	-	-	62,00	37,80	4,1	
61,8	-	M6x1	74,1	100,0	T210	UC210G2	CO	CC	35,10	23,20	2,5	50
61,8	-	M6x1	74,1	100,0	T210	US210G2	CO	CC	35,10	23,20	2,5	
-	69,9	M6x1	89,5	100,0	T210	ES210G2	COE	CCE	35,10	23,20	2,5	
-	69,9	M6x1	89,5	100,0	T210	EX210G2	COE	CCE	35,10	23,20	2,7	
-	75,0	M6x1	75,6	110,0	T211	UK211G2H	CO	CC	43,55	29,20	4,0	
68,7	-	M6x1	-	-	T310	UC310G2	-	-	62,00	37,80	4,0	
-	76,2	M6x1	-	-	T310	EX310G2	-	-	62,00	37,80	4,2	
-	75,0	M6x1	-	-	T311	UK311G2H	-	-	71,50	44,80	6,4	



→ Take-up unit

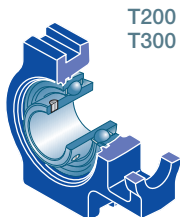

T200
T300

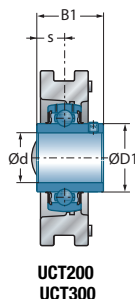
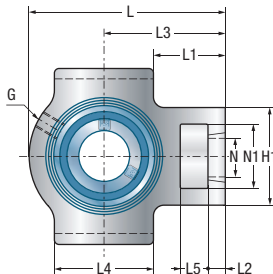
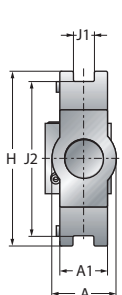

UCT200
UCT300

Shaft diameter		Unit		Main dimensions [mm]																									
d mm		L	H	J1	J2	A	A1	L1	L2	L3	L4	L5	H1	N	N1	s1	B	B1	s										
55	UCT211	171	146	22	130	64	38	58,5	19	106	95	25	102	35	64	-	-	55,6	22,2										
	UST211	171	146	22	130	64	38	58,5	19	106	95	25	102	35	64	-	-	45,3	11,8										
	EST211	171	146	22	130	64	38	58,5	19	106	95	25	102	35	64	-	-	48,4	12,0										
	EXT211	171	146	22	130	64	38	58,5	19	106	95	25	102	35	64	-	-	71,3	27,7										
	UKT212H	194	146	22	130	64	42	68,0	19	119	102	32	102	35	64	31,0	62	-	-										
	UCT311	207	163	22	150	66	44	69,5	23	127	115	29	105	39	66	-	-	66,0	25,0										
	EXT311	207	163	22	150	66	44	69,5	23	127	115	29	105	39	66	-	-	73,0	27,8										
	UKT312H	220	178	22	160	71	46	73,5	25	135	123	31	113	41	71	36,5	62	-	-										
60	UCT212	194	146	22	130	64	42	68,0	19	119	102	32	102	35	64	-	-	65,1	25,4										
	UST212	194	146	22	130	64	42	68,0	19	119	102	32	102	35	64	-	-	53,7	14,9										
	EST212	194	146	22	130	64	42	68,0	19	119	102	32	102	35	64	-	-	49,3	12,0										
	EXT212	194	146	22	130	64	42	68,0	19	119	102	32	102	35	64	-	-	77,7	30,9										
	UKT213H	224	167	26	151	70	44	76,5	21	137	121	32	111	41	70	32,0	65	-	-										
	UCT312	220	178	22	160	71	46	73,5	25	135	123	31	113	41	71	-	-	71,0	26,0										
	EXT312	220	178	22	160	71	46	73,5	25	135	123	31	113	41	71	-	-	79,4	31,0										
	UKT313H	238	190	26	170	80	50	79,0	27	146	134	32	116	43	70	38,5	65	-	-										
65	UCT213	224	167	26	151	70	44	76,5	21	137	121	32	111	41	70	-	-	65,1	25,4										
	EXT213	224	167	26	151	70	44	76,5	21	137	121	32	111	41	70	-	-	85,7	34,1										
	UKT215H	232	167	26	151	70	48	79,5	21	140	121	32	111	41	70	35,5	73	-	-										
	UCT313	238	190	26	170	80	50	79,0	27	146	134	32	116	43	70	-	-	75,0	30,0										
	EXT313	238	190	26	170	80	50	79,0	27	146	134	32	116	43	70	-	-	85,7	32,5										
	UKT315H	262	216	26	192	90	55	85,0	27	160	150	36	132	46	85	42,5	73	-	-										
70	UCT214	224	167	26	151	70	46	76,5	21	137	121	32	111	41	70	-	-	74,6	30,2										
	EXT214	224	167	26	151	70	46	76,5	21	137	121	32	111	41	70	-	-	85,7	34,1										
	UKT216H	235	184	26	165	70	51	79,5	21	140	121	32	111	41	70	39,0	78	-	-										
	UCT314	252	202	26	180	90	52	85,0	27	155	140	36	130	46	85	-	-	78,0	33,0										
	EXT314	252	202	26	180	90	52	85,0	27	155	140	36	130	46	85	-	-	92,1	34,2										
	UKT316H	282	230	30	204	102	60	94,0	30	174	160	42	150	53	98	44,5	78	-	-										

* = equipped with two open protective caps for passing shafts; suffix CO or COE
 ** = equipped with one open and one closed protective cap for shaft ends; suffix CC or CCE

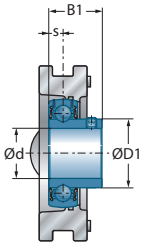

UST200

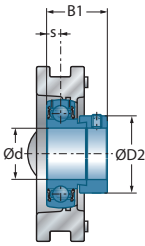

EST200

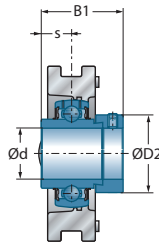

EXT200
EXT300

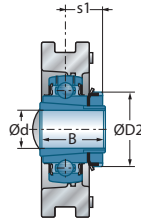

UKT200H
UKT300H

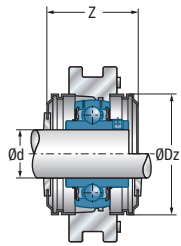

UCT200CO(CC)

Main dimensions [mm]

Main dimensions [mm]					Housing	Bearing insert	Open protective cap**	Closed protective cap**	Dynamic load rating	Static load rating	Weight	Shaft diameter	
D1	D2	G	Z	Dz					C_r [kN]	C_{0r} [kN]	kg	d mm	
69,0	-	M6x1	75,6	110,0	T211	UC211G2	CO	CC	43,55	29,20	3,9	55	
69,0	-	M6x1	75,6	110,0	T211	US211G2	CO	CC	43,55	29,20	3,8		
-	76,2	M6x1	102,4	110,0	T211	ES211G2	COE	CCE	43,55	29,20	3,6		
-	76,2	M6x1	102,4	110,0	T211	EX211G2	COE	CCE	43,55	29,20	4,2		
-	80,0	M6x1	88,6	120,0	T212	UK212G2H	CO	CC	52,50	32,80	4,7		
74,9	-	M6x1	-	-	T311	UC311G2	-	-	71,50	44,80	6,1		
-	83,0	M6x1	-	-	T311	EX311G2	-	-	71,50	44,80	6,5		
-	80,0	M6x1	-	-	T312	UK312G2H	-	-	81,60	51,80	7,5		
-	80,0	M6x1	-	-	T312	UK312G2H	-	-	81,60	51,80	7,5		
74,9	-	M6x1	88,6	120,0	T212	UC212G2	CO	CC	52,50	32,80	4,7	60	
74,9	-	M6x1	88,6	120,0	T212	US212G2	CO	CC	52,50	32,80	4,5		
-	84,2	M6x1	109,8	120,0	T212	ES212G2	COE	CCE	52,50	32,80	4,4		
-	84,2	M6x1	109,8	120,0	T212	EX212G2	COE	CCE	52,50	32,80	5,1		
-	85,0	M6x1	88,6	132,0	T213	UK213G2H	CO	CC	57,20	40,00	6,8		
81,0	-	M6x1	-	-	T312	UC312G2	-	-	81,60	51,80	7,6		
-	89,0	M6x1	-	-	T312	EX312G2	-	-	81,60	51,80	7,9		
-	85,0	M6x1	-	-	T313	UK313G2H	-	-	93,86	60,50	9,5		
-	85,0	M6x1	-	-	T313	UK313G2H	-	-	93,86	60,50	9,5		
82,0	-	M6x1	88,6	132,0	T213	UC213G2	CO	CC	57,20	40,00	6,8	65	
-	86,0	M6x1	117,8	132,0	T213	EX213G2	COE	CCE	57,20	40,00	7,3		
-	98,0	M10x1	-	-	T215	UK215G2H	-	-	66,00	49,50	7,6		
87,5	-	M6x1	-	-	T313	UC313G2	-	-	93,86	60,50	9,5		
-	97,0	M6x1	-	-	T313	EX313G2	-	-	93,86	60,50	9,9		
-	98,0	M10x1	-	-	T315	UK315G2H	-	-	113,36	76,80	13,2		
-	98,0	M10x1	-	-	T315	UK315G2H	-	-	113,36	76,80	13,2		
86,5	-	M10x1	-	-	T214	UC214G2	-	-	62,00	45,00	6,9		70
-	96,8	M10x1	-	-	T214	EX214G2	-	-	62,00	45,00	7,4		
-	105,0	M10x1	-	-	T216	UK216G2H	-	-	72,50	54,20	8,7		
94,0	-	M10x1	-	-	T314	UC314G2	-	-	104,26	68,00	11,1		
-	102,0	M10x1	-	-	T314	EX314G2	-	-	104,26	68,00	11,7		
-	105,0	M10x1	-	-	T316	UK316G2H	-	-	122,85	86,50	16,2		
-	105,0	M10x1	-	-	T316	UK316G2H	-	-	122,85	86,50	16,2		

→ Take-up unit

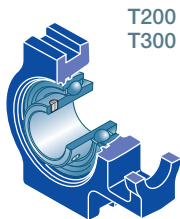

T200
T300

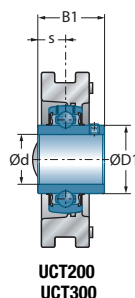
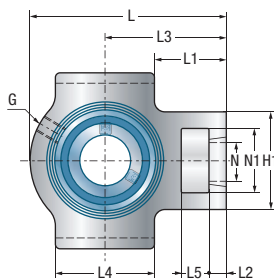
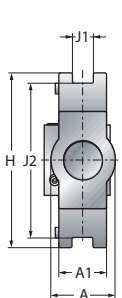

UCT200
UCT300

Shaft diameter		Unit		Main dimensions [mm]																			
d mm		L	H	J1	J2	A	A1	L1	L2	L3	L4	L5	H1	N	N1	s1	B	B1	s				
75	UCT215	232	167	26	151	70	48	79,5	21	140	121	32	111	41	70	-	-	77,8	33,3				
	EXT215	232	167	26	151	70	48	79,5	21	140	121	32	111	41	70	-	-	92,1	37,3				
	UKT217H	260	198	30	173	73	54	83,5	29	162	157	38	124	48	73	40,0	82	-	-				
	UCT315	262	216	26	192	90	55	85,0	27	160	150	36	132	46	85	-	-	82,0	32,0				
	EXT315	262	216	26	192	90	55	85,0	27	160	150	36	132	46	85	-	-	100,0	37,3				
	UKT317H	298	240	32	214	102	64	98,0	32	183	170	42	152	53	98	48,0	82	-	-				
80	UCT216	235	184	26	165	70	51	79,5	21	140	121	32	111	41	70	-	-	82,6	33,3				
	EXT216	235	184	26	165	70	51	79,5	21	140	121	32	111	41	70	-	-	95,2	37,3				
	UCT316	282	230	30	204	102	60	94,0	30	174	160	42	150	53	98	-	-	86,0	34,0				
	EXT316	282	230	30	204	102	60	94,0	30	174	160	42	150	53	98	-	-	106,4	40,5				
	UKT318H	312	255	32	228	110	66	104,5	32	192	175	46	160	57	106	48,0	86	-	-				
	85	UCT217	260	198	30	173	73	54	83,5	29	162	157	38	124	48	73	-	-	85,7	34,1			
EXT217		260	198	30	173	73	54	83,5	29	162	157	38	124	48	73	-	-	73,2	23,4				
UCT317		298	240	32	214	102	64	98,0	32	183	170	42	152	53	98	-	-	96,0	40,0				
EXT317		298	240	32	214	102	64	98,0	32	183	170	42	152	53	98	-	-	109,5	42,0				
UKT319H		322	270	35	240	110	72	107,0	33	197	180	46	165	57	106	52,0	90	-	-				
90		UCT318	312	255	32	228	110	66	104,5	32	192	175	46	160	57	106	-	-	96,0	40,0			
	EXT318	312	255	32	228	110	66	104,5	32	192	175	46	160	57	106	-	-	115,9	43,6				
	UKT320H	345	290	35	260	120	75	110,0	34	210	200	48	175	59	115	54,0	97	-	-				
95	UCT319	322	270	35	240	110	72	107,0	33	197	180	46	165	57	106	-	-	103,0	41,0				
	EXT319	322	270	35	240	110	72	107,0	33	197	180	46	165	57	106	-	-	122,3	46,8				
100	UCT320	345	290	35	260	120	75	110,0	34	210	200	48	175	59	115	-	-	108,0	42,0				
	EXT320	345	290	35	260	120	75	110,0	34	210	200	48	175	59	115	-	-	128,6	50,0				
	UKT322H	385	320	38	285	130	80	127,5	40	235	215	52	185	65	125	61,0	105	-	-				
105	UCT321	347	290	35	260	120	75	112,0	34	212	200	48	175	59	115	-	-	112,0	44,0				
110	UCT322	385	320	38	285	130	80	127,5	40	235	215	52	185	65	125	-	-	117,0	46,0				
	UKT324H	432	355	45	320	140	90	152,0	44	267	230	60	210	70	140	65,0	112	-	-				

* = equipped with two open protective caps for passing shafts; suffix C0 or COE
 ** = equipped with one open and one closed protective cap for shaft ends; suffix CC or CCE

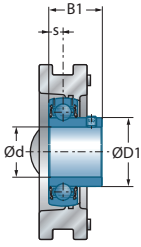

UST200

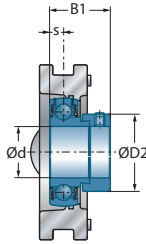

EST200

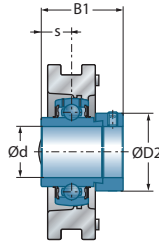

EXT200
EXT300

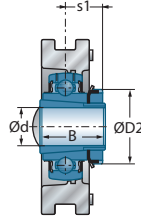

UKT200H
UKT300H

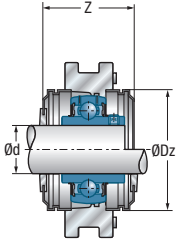

UCT200C0(CC)

Main dimensions [mm]

Main dimensions [mm]					Housing	Bearing insert	Open protective cap**	Closed protective cap**	Dynamic load rating	Static load rating	Weight	Shaft diameter
D1	D2	G	Z	Dz					C_r [kN]	C_{0r} [kN]	kg	d mm
91,5	-	M10x1	-	-	T215	UC215G2	-	-	66,00	49,50	7,2	75
-	102,0	M10x1	-	-	T215	EX215G2	-	-	66,00	49,50	7,9	
-	110,0	M10x1	-	-	T217	UK217G2H	-	-	83,20	63,80	11,2	
100,5	-	M10x1	-	-	T315	UC315G2	-	-	113,36	76,80	12,5	80
-	113,0	M10x1	-	-	T315	EX315G2	-	-	113,36	76,80	13,5	
-	110,0	M10x1	-	-	T317	UK317G2H	-	-	132,60	96,50	19,0	
98,0	-	M10x1	-	-	T216	UC216G2	-	-	72,50	54,20	8,2	85
-	110,0	M10x1	-	-	T216	EX216G2	-	-	72,50	54,20	8,6	
107,9	-	M10x1	-	-	T316	UC316G2	-	-	122,85	86,50	16,0	
-	119,0	M10x1	-	-	T316	EX316G2	-	-	122,85	86,50	17,1	
-	120,0	M10x1	-	-	T318	UK318G2H	-	-	143,00	108,00	21,6	
105,1	-	M10x1	-	-	T217	UC217G2	-	-	83,20	63,80	10,8	90
-	119,0	M10x1	-	-	T217	EX217G2	-	-	83,20	63,80	11,1	
114,0	-	M10x1	-	-	T317	UC317G2	-	-	132,60	96,50	18,9	
-	127,0	M10x1	-	-	T317	EX317G2	-	-	132,60	96,50	20,0	
-	125,0	M10x1	-	-	T319	UK319G2H	-	-	156,00	122,00	26,2	
120,0	-	M10x1	-	-	T318	UC318G2	-	-	143,00	108,00	21,5	95
-	133,0	M10x1	-	-	T318	EX318G2	-	-	143,00	108,00	22,7	
-	130,0	M10x1	-	-	T320	UK320G2H	-	-	171,60	140,00	30,4	
126,5	-	M10x1	-	-	T319	UC319G2	-	-	156,00	122,00	25,9	100
-	140,0	M10x1	-	-	T319	EX319G2	-	-	156,00	122,00	27,4	
134,5	-	M10x1	-	-	T320	UC320G2	-	-	171,60	140,00	30,6	105
-	146,0	M10x1	-	-	T320	EX320G2	-	-	171,60	140,00	32,4	
-	145,0	M10x1	-	-	T322	UK322G2H	-	-	205,00	178,00	41,9	
140,5	-	M10x1	-	-	T321	UC321G2	-	-	182,00	155,00	31,6	110
149,0	-	M10x1	-	-	T322	UC322G2	-	-	205,00	178,00	38,6	
-	155,0	M10x1	-	-	T324	UK324G2H	-	-	228,00	208,00	56,6	



→ Take-up unit

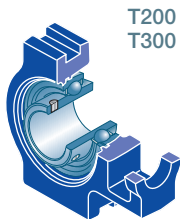

T200
T300

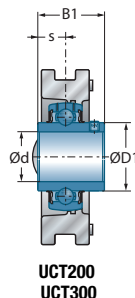
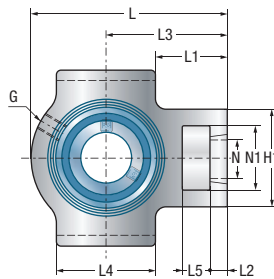
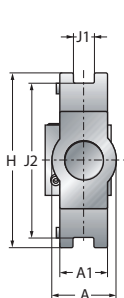

UCT200
UCT300

Shaft diameter		Unit		Main dimensions [mm]																	
d mm		L	H	J1	J2	A	A1	L1	L2	L3	L4	L5	H1	N	N1	s1	B	B1	s		
115	UKT326H	465	385	50	350	150	100	165,0	47	285	240	65	220	75	150	69,0	121	-	-		
120	UCT324	432	355	45	320	140	90	152,0	44	267	230	60	210	70	140	-	-	126,0	51,0		
125	UKT328H	515	415	50	380	155	100	187,5	52	315	255	70	230	80	160	73,0	131	-	-		
130	UCT326	465	385	50	350	150	100	165,0	47	285	240	65	220	75	150	-	-	135,0	54,0		
140	UCT328	515	415	50	380	155	100	187,5	52	315	255	70	230	80	160	-	-	145,0	59,0		

* = equipped with two open protective caps for passing shafts: suffix CO or COE
 ** = equipped with one open and one closed protective cap for shaft ends: suffix CC or CCE

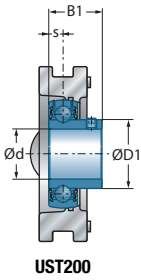

UST200

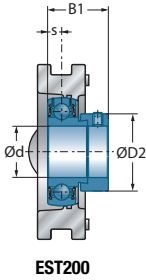

EST200

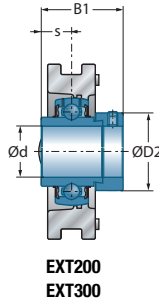

EXT200
EXT300

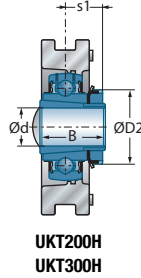

UKT200H
UKT300H

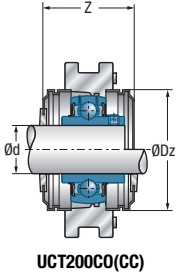

UCT200CO(CC)

Main dimensions [mm]

Main dimensions [mm]					Housing	Bearing insert	Open protective cap**	Closed protective cap**	Dynamic load rating	Static load rating	Weight	Shaft diameter
D1	D2	G	Z	Dz					C_r [kN]	C_{0r} [kN]	kg	d mm
176,1	165,0	M10x1	-	-	T326	UK326G2H	-	-	252,00	242,00	72,7	115
163,0	-	M10x1	-	-	T324	UC324G2	-	-	228,00	208,00	53,9	120
-	180,0	M10x1	-	-	T328	UK328G2H	-	-	275,00	272,00	89,2	125
177,0	-	M10x1	-	-	T326	UC326G2	-	-	252,00	242,00	67,8	130
190,0	-	M10x1	-	-	T328	UC328G2	-	-	275,00	272,00	83,2	140



→ Take-up unit with frame

T200 + WB

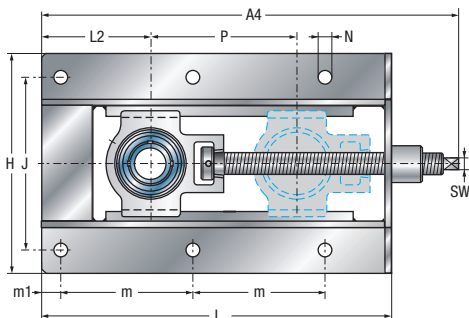
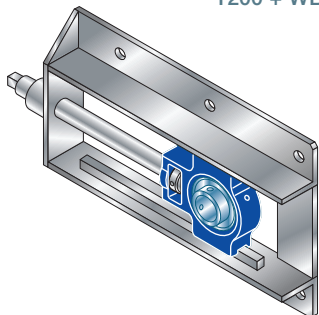

Trapezoidal screw thread

T201-T205 : TR 16x4

T206 : TR 20x4

T207-T210 : TR 24x5

T211-T213 : TR 30x6

Main dimensions [mm]

d mm	Unit	Main dimensions [mm]																	
		L	H	J	m	m1	A	A2	A4	L2	P	T	e	N	SW	s1	B	B1	
12	UCT201+WB	317	199	154	117	19	50	47,3	367	83	150	6	29	12	11	-	-	31,0	
	EXT201+WB	317	199	154	117	19	50	55,5	367	83	150	6	29	12	11	-	-	43,5	
15	UCT202+WB	317	199	154	117	19	50	47,3	367	83	150	6	29	12	11	-	-	31,0	
	EXT202+WB	317	199	154	117	19	50	55,5	367	83	150	6	29	12	11	-	-	43,5	
17	UCT203+WB	317	199	154	117	19	50	47,3	367	83	150	6	29	12	11	-	-	31,0	
	EXT203+WB	317	199	154	117	19	50	55,5	367	83	150	6	29	12	11	-	-	43,5	
20	UCT204+WB	317	199	154	117	19	50	47,3	367	83	150	6	29	12	11	-	-	31,0	
	UST204+WB	317	199	154	117	19	50	47,0	367	83	150	6	29	12	11	-	-	25,0	
	EST204+WB	317	199	154	117	19	50	52,4	367	83	150	6	29	12	11	-	-	30,9	
	EXT204+WB	317	199	154	117	19	50	55,5	367	83	150	6	29	12	11	-	-	43,5	
	UKT205H+WB	317	199	154	117	19	50	47,5	368	83	150	6	29	12	11	18,5	35,0	-	
25	UCT205+WB	317	199	154	117	19	50	48,7	368	83	150	6	29	12	11	-	-	34,0	
	UST205+WB	317	199	154	117	19	50	48,5	368	83	150	6	29	12	11	-	-	27,0	
	EST205+WB	317	199	154	117	19	50	52,4	368	83	150	6	29	12	11	-	-	30,9	
	EXT205+WB	317	199	154	117	19	50	55,9	368	83	150	6	29	12	11	-	-	44,3	
	UKT206H+WB	337	212	166	127	19	50	50,5	396	95	150	6	30	12	11	20,5	38,0	-	
30	UCT206+WB	337	212	166	127	19	50	52,2	396	95	150	6	30	12	11	-	-	38,1	
	UST206+WB	337	212	166	127	19	50	52,0	396	95	150	6	30	12	11	-	-	30,0	
	EST206+WB	337	212	166	127	19	50	56,7	396	95	150	6	30	12	11	-	-	35,7	
	EXT206+WB	337	212	166	127	19	50	60,1	396	95	150	6	30	12	11	-	-	48,3	
	UKT207H+WB	429	212	166	173	19	50	52,5	490	99	230	6	30	12	12	22,5	43,0	-	
35	UCT207+WB	429	212	166	173	19	50	55,4	490	99	230	6	30	12	12	-	-	42,9	
	UST207+WB	429	212	166	173	19	50	53,5	490	99	230	6	30	12	12	-	-	32,0	
	EST207+WB	429	212	166	173	19	50	59,4	490	99	230	6	30	12	12	-	-	38,9	
	EXT207+WB	429	212	166	173	19	50	62,3	490	99	230	6	30	12	12	-	-	51,1	
	UKT208H+WB	520	233	192	219	22	50	54,5	591	108	300	6	30	15	15	24,5	46,0	-	

* = equipped with two open protective caps for passing shafts; suffix CO or COE
 ** = equipped with one open and one closed protective cap for shaft ends; suffix CC or CCE

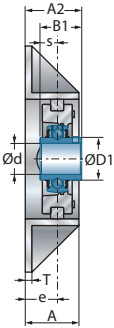

UCT200+WB

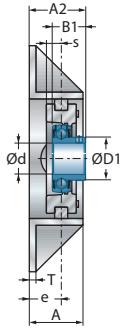

UST200+WB

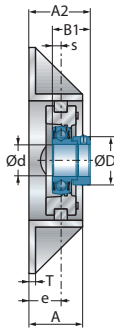

EST200+WB

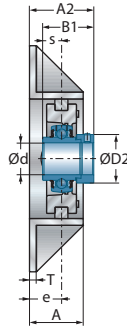

EXT200+WB

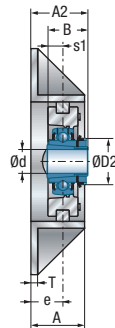

UKT200H+WB

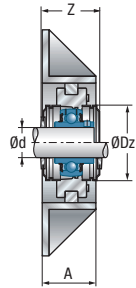

UCT 200C0(CC)+WB

Main dimensions [mm]

Main dimensions [mm]					Housing	Bearing insert	Stretcher frame	Open protective cap**	Closed protective cap**	Dynamic load rating	Static load rating	Weight	Shaft diameter
s	D1	D2	Z	Dz						C _r [kN]	C _{0r} [kN]	kg	d mm
12,7	29,0	-	43,7	54,0	T204	UC201G2	WB205	CO	CC	12,80	6,65	5,2	12
17,0	-	33,3	57,1	54,0	T204	EX201G2	WB205	COE	CCE	12,80	6,65	5,3	
12,7	29,0	-	43,7	54,0	T204	UC202G2	WB205	CO	CC	12,80	6,65	5,2	15
17,0	-	33,3	57,1	54,0	T204	EX202G2	WB205	COE	CCE	12,80	6,65	5,3	
12,7	29,0	-	43,7	54,0	T204	UC203G2	WB205	CO	CC	12,80	6,65	5,2	17
17,0	-	33,3	57,1	54,0	T204	EX203G2	WB205	COE	CCE	12,80	6,65	5,3	
12,7	29,0	-	43,7	54,0	T204	UC204G2	WB205	CO	CC	12,80	6,65	5,2	20
7,0	29,0	-	43,7	54,0	T204	US204G2	WB205	CO	CC	12,80	6,65	5,1	
7,5	-	33,3	62,1	54,0	T204	ES204G2	WB205	COE	CCE	12,80	6,65	5,2	
17,0	-	33,3	62,1	54,0	T204	EX204G2	WB205	COE	CCE	12,80	6,65	5,2	
-	-	38,0	47,5	60,0	T205	UK205G2H	WB205	CO	CC	14,00	7,88	5,2	
14,3	34,0	-	47,5	60,0	T205	UC205G2	WB205	CO	CC	14,00	7,88	5,2	25
7,5	34,0	-	47,5	60,0	T205	US205G2	WB205	CO	CC	14,00	7,88	5,2	
7,5	-	38,1	64,7	60,0	T205	ES205G2	WB205	COE	CCE	14,00	7,88	5,2	
17,4	-	38,1	64,7	60,0	T205	EX205G2	WB205	COE	CCE	14,00	7,88	5,3	
-	-	45,0	52,5	70,0	T206	UK206G2H	WB206	CO	CC	19,50	11,20	6,3	
15,9	40,3	-	52,5	70,0	T206	UC206G2	WB206	CO	CC	19,50	11,20	6,2	30
8,0	40,3	-	52,5	70,0	T206	US206G2	WB206	CO	CC	19,50	11,20	6,2	
9,0	-	44,5	70,7	70,0	T206	ES206G2	WB206	COE	CCE	19,50	11,20	6,2	
18,2	-	44,5	70,7	70,0	T206	EX206G2	WB206	COE	CCE	19,50	11,20	6,3	
-	-	52,0	59,1	80,0	T207	UK207G2H	WB207	CO	CC	25,70	15,20	8,4	
17,5	48,0	-	59,1	80,0	T207	UC207G2	WB207	CO	CC	25,70	15,20	8,4	35
8,5	48,0	-	59,1	80,0	T207	US207G2	WB207	CO	CC	25,70	15,20	8,3	
9,5	-	55,6	77,7	80,0	T207	ES207G2	WB207	COE	CCE	25,70	15,20	8,4	
18,8	-	55,6	77,7	80,0	T207	EX207G2	WB207	COE	CCE	25,70	15,20	8,5	
-	-	58,0	68,6	88,0	T208	UK208G2H	WB210	CO	CC	29,60	18,20	11,8	



→ Take-up unit with frame

T200 + WB

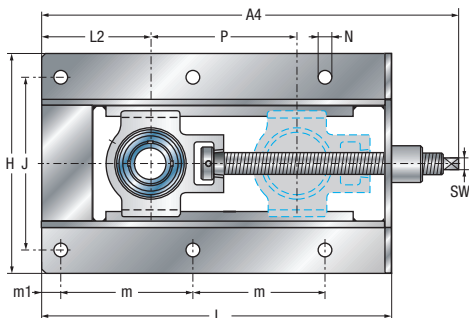
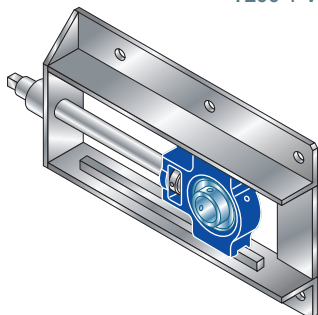

Trapezoidal screw thread

T201-T205	: TR 16x4
T206	: TR 20x4
T207-T210	: TR 24x5
T211-T213	: TR 30x6

Main dimensions [mm]

d mm	Unit	Main dimensions [mm]																	
		L	H	J	m	m1	A	A2	A4	L2	P	T	e	N	SW	s1	B	B1	
40	UCT208+WB	520	233	192	219	22	50	60,2	591	108	300	6	30	15	15	-	-	49,2	
	UST208+WB	520	233	192	219	22	50	55,0	591	108	300	6	30	15	15	-	-	34,0	
	EST208+WB	520	233	192	219	22	50	62,7	591	108	300	6	30	15	15	-	-	43,7	
	EXT208+WB	520	233	192	219	22	50	64,9	591	108	300	6	30	15	15	-	-	56,3	
	UKT209H+WB	520	233	192	219	22	50	56,0	590	108	300	6	30	15	15	26,0	50,0	-	
45	UCT209+WB	520	233	192	219	22	50	60,2	590	108	300	6	30	15	15	-	-	49,2	
	UST209+WB	520	233	192	219	22	50	61,0	590	108	300	6	30	15	15	-	-	41,2	
	EST209+WB	520	233	192	219	22	50	62,7	590	108	300	6	30	15	15	-	-	43,7	
	EXT209+WB	520	233	192	219	22	50	64,9	590	108	300	6	30	15	15	-	-	56,3	
	UKT210H+WB	520	233	192	219	22	50	57,5	593	108	300	6	30	15	15	27,5	55,0	-	
50	UCT210+WB	520	233	192	219	22	50	62,6	593	108	300	6	30	15	15	-	-	51,6	
	UST210+WB	520	233	192	219	22	50	62,6	593	108	300	6	30	15	15	-	-	43,5	
	EST210+WB	520	233	192	219	22	50	62,7	593	108	300	6	30	15	15	-	-	43,7	
	EXT210+WB	520	233	192	219	22	50	68,1	593	108	300	6	30	15	15	-	-	62,7	
	UKT211H+WB	542	301	240	230	22	65	67,0	631	114	300	6	38	15	19	29,0	59,0	-	
55	UCT211+WB	542	301	240	230	22	65	71,4	631	114	300	6	38	15	19	-	-	55,6	
	UST211+WB	542	301	240	230	22	65	71,5	631	114	300	6	38	15	19	-	-	45,3	
	EST211+WB	542	301	240	230	22	65	74,4	631	114	300	6	38	15	19	-	-	48,4	
	EXT211+WB	542	301	240	230	22	65	81,6	631	114	300	6	38	15	19	-	-	71,3	
	UKT212H+WB	568	301	240	243	22	65	69,0	651	127	300	6	38	15	19	31,0	62,0	-	
60	UCT212+WB	568	301	240	243	22	65	77,7	651	127	300	6	38	15	19	-	-	65,1	
	UST212+WB	568	301	240	243	22	65	76,8	651	127	300	6	38	15	19	-	-	53,7	
	EST212+WB	568	301	240	243	22	65	75,3	651	127	300	6	38	15	19	-	-	49,3	
	EXT212+WB	568	301	240	243	22	65	84,8	651	127	300	6	38	15	19	-	-	77,7	
	UKT213H+WB	606	322	260	260	22	65	70,0	699	144	300	6	38	15	24	32,0	65,0	-	
65	UCT213+WB	606	322	260	260	22	65	77,7	699	144	300	6	38	15	24	-	-	65,1	
	EXT213+WB	606	322	260	260	22	65	89,6	699	144	300	6	38	15	24	-	-	85,7	

* = equipped with two open protective caps for passing shafts; suffix CO or COE
 ** = equipped with one open and one closed protective cap for shaft ends; suffix CC or CCE

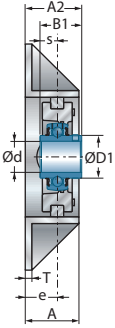

UCT200+WB

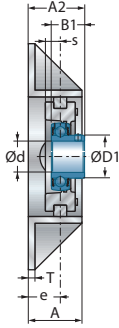

UST200+WB

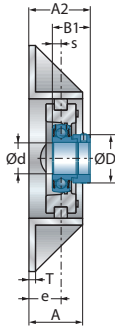

EST200+WB

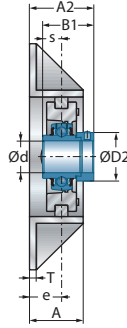

EXT200+WB

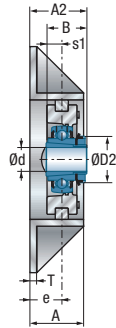

UKT200H+WB

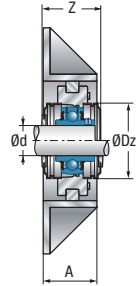

UCT 200C(CC)+WB

Main dimensions [mm]

Main dimensions [mm]					Housing	Bearing insert	Stretcher frame	Open protective cap**	Closed protective cap**	Dynamic load rating	Static load rating	Weight	Shaft diameter
s	D1	D2	Z	Dz						C_r [kN]	C_{0r} [kN]	kg	d mm
19,0	53,0	-	68,6	88,0	T208	UC208G2	WB210	CO	CC	29,60	18,20	11,7	40
9,0	53,0	-	68,6	88,0	T208	US208G2	WB210	CO	CC	29,60	18,20	11,7	
11,0	-	60,3	80,8	88,0	T208	ES208G2	WB210	COE	CCE	29,60	18,20	11,8	
21,4	-	60,3	80,8	88,0	T208	EX208G2	WB210	COE	CCE	29,60	18,20	11,9	
-	-	65,0	68,6	95,0	T209	UK209G2H	WB210	COE	CC	31,85	20,80	11,9	
19,0	57,2	-	68,6	95,0	T209	UC209G2	WB210	CO	CC	31,85	20,80	11,8	45
10,2	57,2	-	68,6	95,0	T209	US209G2	WB210	CO	CC	31,85	20,80	11,8	
11,0	-	63,5	82,8	95,0	T209	ES209G2	WB210	COE	CCE	31,85	20,80	11,8	
21,4	-	63,5	82,8	95,0	T209	EX209G2	WB210	COE	CCE	31,85	20,80	12,0	
-	-	70,0	74,1	100,0	T210	UK210G2H	WB210	CO	CC	35,10	23,20	12,2	
19,0	61,8	-	74,1	100,0	T210	UC210G2	WB210	CO	CC	35,10	23,20	12,0	50
10,9	61,8	-	74,1	100,0	T210	US210G2	WB210	CO	CC	35,10	23,20	12,0	
11,0	-	69,9	89,5	100,0	T210	ES210G2	WB210	COE	CCE	35,10	23,20	12,0	
24,6	-	69,9	89,5	100,0	T210	EX210G2	WB210	COE	CCE	35,10	23,20	12,2	
-	-	75,0	75,6	110,0	T211	UK211G2H	WB211	CO	CC	43,55	29,20	18,5	
22,2	69,0	-	75,6	110,0	T211	UC211G2	WB211	CO	CC	43,55	29,20	18,4	55
11,8	69,0	-	75,6	110,0	T211	US211G2	WB211	CO	CC	43,55	29,20	18,4	
12,0	-	76,2	102,4	110,0	T211	ES211G2	WB211	COE	CCE	43,55	29,20	18,2	
27,7	-	76,2	102,4	110,0	T211	EX211G2	WB211	COE	CCE	43,55	29,20	18,7	
-	-	80,0	88,6	120,0	T212	UK212G2H	WB212	CO	CC	52,50	32,80	20,2	
25,4	74,9	-	88,6	120,0	T212	UC212G2	WB212	CO	CC	52,50	32,80	20,2	60
14,9	74,9	-	88,6	120,0	T212	US212G2	WB212	CO	CC	52,50	32,80	20,0	
12,0	-	84,2	109,8	120,0	T212	ES212G2	WB212	COE	CCE	52,50	32,80	19,9	
30,9	-	84,2	109,8	120,0	T212	EX212G2	WB212	COE	CCE	52,50	32,80	20,6	
-	-	85,0	88,6	132,0	T213	UK213G2H	WB213	CO	CC	57,20	40,00	25,3	
25,4	82,0	-	88,6	132,0	T213	UC213G2	WB213	CO	CC	57,20	40,00	25,3	65
34,1	-	86,0	117,8	132,0	T213	EX213G2	WB213	COE	CCE	57,20	40,00	25,8	



→ Conveyor belt tensioner unit

SP200

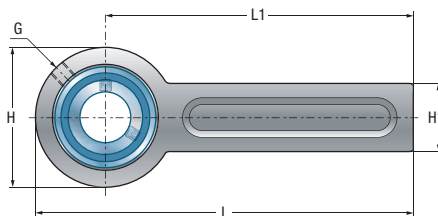
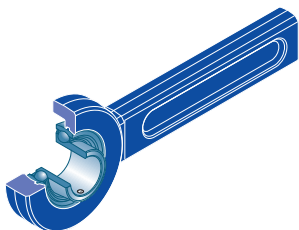

Shaft diameter		Unit		Main dimensions [mm]													
d mm		L	H	L1	H1	A	s1	B	B1	s	D1	D2	G	Z	Dz		
12	UCSP201	264	78	225	41	21	-	-	31,0	12,7	29,0	-	R1/8"	48,8	60,0		
	USSP201	264	78	225	41	21	-	-	22,0	6,0	24,6	-	R1/8"	48,8	60,0		
	ESSP201	264	78	225	41	21	-	-	28,6	6,5	-	28,6	R1/8"	66,0	60,0		
	EXSP201	264	78	225	41	21	-	-	43,5	17,0	-	33,3	R1/8"	66,0	60,0		
15	UCSP202	264	78	225	41	21	-	-	31,0	12,7	29,0	-	R1/8"	48,8	60,0		
	USSP202	264	78	225	41	21	-	-	22,0	6,0	24,6	-	R1/8"	48,8	60,0		
	ESSP202	264	78	225	41	21	-	-	28,6	6,5	-	28,6	R1/8"	66,0	60,0		
	EXSP202	264	78	225	41	21	-	-	43,5	17,0	-	33,3	R1/8"	66,0	60,0		
17	UCSP203	264	78	225	41	21	-	-	31,0	12,7	29,0	-	R1/8"	48,8	60,0		
	USSP203	264	78	225	41	21	-	-	22,0	6,0	24,6	-	R1/8"	48,8	60,0		
	ESSP203	264	78	225	41	21	-	-	28,6	6,5	-	28,6	R1/8"	66,0	60,0		
	EXSP203	264	78	225	41	21	-	-	43,5	17,0	-	33,3	R1/8"	66,0	60,0		
20	UCSP204	264	78	225	41	21	-	-	31,0	12,7	29,0	-	R1/8"	48,8	60,0		
	USSP204	264	78	225	41	21	-	-	25,0	7,0	29,0	-	R1/8"	48,8	60,0		
	ESSP204	264	78	225	41	21	-	-	30,9	7,5	-	33,3	R1/8"	66,0	60,0		
	EXSP204	264	78	225	41	21	-	-	43,5	17,0	-	33,3	R1/8"	66,0	60,0		
	UKSP205H	264	78	225	41	21	18,5	35,0	-	-	-	38,0	R1/8"	48,8	60,0		
25	UCSP205	264	78	225	41	21	-	-	34,0	14,3	34,0	-	R1/8"	48,8	60,0		
	USSP205	264	78	225	41	21	-	-	27,0	7,5	34,0	-	R1/8"	48,8	60,0		
	ESSP205	264	78	225	41	21	-	-	30,9	7,5	-	38,1	R1/8"	66,0	60,0		
	EXSP205	264	78	225	41	21	-	-	44,3	17,4	-	38,1	R1/8"	66,0	60,0		
	UKSP206H	274	98	225	41	21	20,5	38,0	-	-	-	45,0	R1/8"	58,4	80,0		
30	UCSP206	274	98	225	41	21	-	-	38,1	15,9	40,3	-	R1/8"	58,4	80,0		
	USSP206	274	98	225	41	21	-	-	30,0	8,0	40,3	-	R1/8"	58,4	80,0		
	ESSP206	274	98	225	41	21	-	-	35,7	9,0	-	44,5	R1/8"	77,0	80,0		
	EXSP206	274	98	225	41	21	-	-	48,3	18,2	-	44,5	R1/8"	77,0	80,0		
	UKSP207H	274	98	225	41	21	22,5	43,0	-	-	-	52,0	R1/8"	58,4	80,0		
35	UCSP207	274	98	225	41	21	-	-	42,9	17,5	48,0	-	R1/8"	58,4	80,0		
	USSP207	274	98	225	41	21	-	-	32,0	8,5	48,0	-	R1/8"	58,4	80,0		
	ESSP207	274	98	225	41	21	-	-	38,9	9,5	-	55,6	R1/8"	77,0	80,0		
	EXSP207	274	98	225	41	21	-	-	51,1	18,8	-	55,6	R1/8"	77,0	80,0		
	UKSP208H	320	120	260	61	31	24,5	46,0	-	-	-	58,0	R1/8"	75,6	100,0		

* = equipped with two open protective caps for passing shafts; suffix CO or COE
 ** = equipped with one open and one closed protective cap for shaft ends; suffix CC or CCE

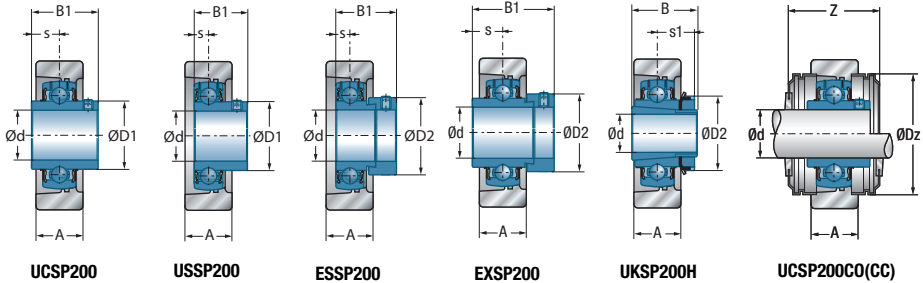

UCSP200

USSP200

ESSP200

EXSP200

UKSP200H

UCSP200C(CC)

Housing

Bearing insert

Stretcher frame
must be ordered
separately
(see p. 542/543)

Open protective
cap**

Closed protective
cap**

Dynamic load rating

Static load rating

Weight

Shaft
diameter

									C_r [kN]	C_{Or} [kN]		d mm
SP203-205/47	UC201G2	SPR1	SPR11	SPR12	SPR14	CO	CC	12,80	6,65	1,7	12	
SP203-205/40	US201G2	SPR1	SPR11	SPR12	SPR14	CO	CC	9,55	4,78	1,6		
SP203-205/40	ES201G2	SPR1	SPR11	SPR12	SPR14	COE	CCE	9,55	4,78	1,6		
SP203-205/47	EX201G2	SPR1	SPR11	SPR12	SPR14	COE	CCE	12,80	6,65	1,8		
SP203-205/47	UC202G2	SPR1	SPR11	SPR12	SPR14	CO	CC	12,80	6,65	1,7	15	
SP203-205/40	US202G2	SPR1	SPR11	SPR12	SPR14	CO	CC	9,55	4,78	1,6		
SP203-205/40	ES202G2	SPR1	SPR11	SPR12	SPR14	COE	CCE	9,55	4,78	1,6		
SP203-205/47	EX202G2	SPR1	SPR11	SPR12	SPR14	COE	CCE	12,80	6,65	1,8		
SP203-205/47	UC203G2	SPR1	SPR11	SPR12	SPR14	CO	CC	12,80	6,65	1,7	17	
SP203-205/40	US203G2	SPR1	SPR11	SPR12	SPR14	CO	CC	9,55	4,78	1,6		
SP203-205/40	ES203G2	SPR1	SPR11	SPR12	SPR14	COE	CCE	9,55	4,78	1,6		
SP203-205/47	EX203G2	SPR1	SPR11	SPR12	SPR14	COE	CCE	12,80	6,65	1,8		
SP203-205/47	UC204G2	SPR1	SPR11	SPR12	SPR14	CO	CC	12,80	6,65	1,7	20	
SP203-205/40	US204G2	SPR1	SPR11	SPR12	SPR14	CO	CC	12,80	6,65	1,6		
SP203-205/40	ES204G2	SPR1	SPR11	SPR12	SPR14	COE	CCE	12,80	6,65	1,7		
SP203-205/47	EX204G2	SPR1	SPR11	SPR12	SPR14	COE	CCE	12,80	6,65	1,7		
SP203-205/52	UK205G2H	SPR1	SPR11	SPR12	SPR14	CO	CC	14,00	7,88	1,7		
SP203-205/52	UC205G2	SPR1	SPR11	SPR12	SPR14	CO	CC	14,00	7,88	1,7	25	
SP203-205/52	US205G2	SPR1	SPR11	SPR12	SPR14	CO	CC	14,00	7,88	1,7		
SP203-205/52	ES205G2	SPR1	SPR11	SPR12	SPR14	COE	CCE	14,00	7,88	1,7		
SP203-205/52	EX205G2	SPR1	SPR11	SPR12	SPR14	COE	CCE	14,00	7,88	1,8		
SP206-207/62	UK206G2H	SPR1	SPR11	SPR12	SPR14	CO	CC	19,50	11,20	2,0		
SP206-207/62	UC206G2	SPR1	SPR11	SPR12	SPR14	CO	CC	19,50	11,20	1,9	30	
SP206-207/62	US206G2	SPR1	SPR11	SPR12	SPR14	CO	CC	19,50	11,20	1,9		
SP206-207/62	ES206G2	SPR1	SPR11	SPR12	SPR14	COE	CCE	19,50	11,20	1,9		
SP206-207/62	EX206G2	SPR1	SPR11	SPR12	SPR14	COE	CCE	19,50	11,20	2,0		
SP206-207/72	UK207G2H	SPR1	SPR11	SPR12	SPR14	CO	CC	25,70	15,20	2,1		
SP206-207/72	UC207G2	SPR1	SPR11	SPR12	SPR14	CO	CC	25,70	15,20	2,1	35	
SP206-207/72	US207G2	SPR1	SPR11	SPR12	SPR14	CO	CC	25,70	15,20	2,0		
SP206-207/72	ES207G2	SPR1	SPR11	SPR12	SPR14	COE	CCE	25,70	15,20	2,1		
SP206-207/72	EX207G2	SPR1	SPR11	SPR12	SPR14	COE	CCE	25,70	15,20	2,2		
SP208-210/80	UK208G2H	SPR2	SPR21	SPR22	SPR24	CO	CC	29,60	18,20	4,3		

→ Conveyor belt tensioner unit

SP200

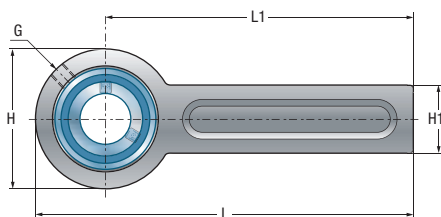
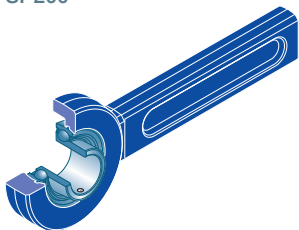

Shaft diameter		Unit		Main dimensions [mm]												
d mm		L	H	L1	H1	A	s1	B	B1	s	D1	D2	G	Z	Dz	
40	UCSP208	320	120	260	61	31	-	-	49,2	19,0	53,0	-	R1/8"	75,6	100,0	
	USSP208	320	120	260	61	31	-	-	34,0	9,0	53,0	-	R1/8"	75,6	100,0	
	ESSP208	320	120	260	61	31	-	-	43,7	11,0	-	60,3	R1/8"	91,0	100,0	
	EXSP208	320	120	260	61	31	-	-	56,3	21,4	-	60,3	R1/8"	91,0	100,0	
	UKSP209H	320	120	260	61	31	26,0	50,0	-	-	-	65,0	R1/8"	75,6	100,0	
45	UCSP209	320	120	260	61	31	-	-	49,2	19,0	57,2	-	R1/8"	75,6	100,0	
	USSP209	320	120	260	61	31	-	-	41,2	10,2	57,2	-	R1/8"	75,6	100,0	
	ESSP209	320	120	260	61	31	-	-	43,7	11,0	-	63,5	R1/8"	91,0	100,0	
	EXSP209	320	120	260	61	31	-	-	56,3	21,4	-	63,5	R1/8"	91,0	100,0	
	UKSP210H	320	120	260	61	31	27,5	55,0	-	-	-	70,0	R1/8"	75,6	100,0	
50	UCSP210	320	120	260	61	31	-	-	51,6	19,0	61,8	-	R1/8"	75,6	100,0	
	USSP210	320	120	260	61	31	-	-	43,5	10,9	61,8	-	R1/8"	75,6	100,0	
	ESSP210	320	120	260	61	31	-	-	43,7	11,0	-	69,9	R1/8"	91,0	100,0	
	EXSP210	320	120	260	61	31	-	-	62,7	24,6	-	69,9	R1/8"	91,0	100,0	

* = equipped with two open protective caps for passing shafts; suffix CO or COE
 ** = equipped with one open and one closed protective cap for shaft ends; suffix CC or CCE

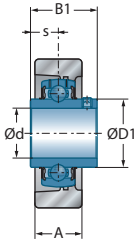

UCSP200

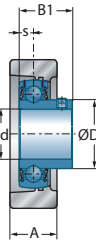

USSP200

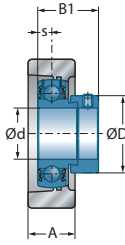

ESSP200

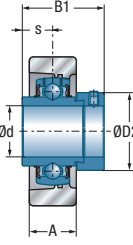

EXSP200

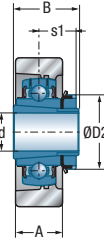

UKSP200H

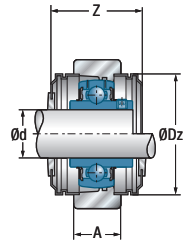

UCSP200CO(CC)

Housing

Bearing insert

Stretcher frame must be ordered separately (see p. 542/543)

Open protective cap**

Closed protective cap**

Dynamic load rating

Static load rating

Weight

Shaft diameter

									C_r [kN]	C_{0r} [kN]		d mm
SP208-210/80	UC208G2	SPR2	SPR21	SPR22	SPR24	CO	CC	29,60	18,20	4,2	40	
SP208-210/80	US208G2	SPR2	SPR21	SPR22	SPR24	CO	CC	29,60	18,20	4,2		
SP208-210/80	ES208G2	SPR2	SPR21	SPR22	SPR24	COE	CCE	29,60	18,20	4,2		
SP208-210/80	EX208G2	SPR2	SPR21	SPR22	SPR24	COE	CCE	29,60	18,20	4,3		
SP208-210/85	UK209G2H	SPR2	SPR21	SPR22	SPR24	CO	CC	31,85	20,80	4,3		
SP208-210/85	UC209G2	SPR2	SPR21	SPR22	SPR24	CO	CC	31,85	20,80	4,2	45	
SP208-210/85	US209G2	SPR2	SPR21	SPR22	SPR24	CO	CC	31,85	20,80	4,2		
SP208-210/85	ES209G2	SPR2	SPR21	SPR22	SPR24	COE	CCE	31,85	20,80	4,2		
SP208-210/85	EX209G2	SPR2	SPR21	SPR22	SPR24	COE	CCE	31,85	20,80	4,4		
SP208-210/90	UK210G2H	SPR2	SPR21	SPR22	SPR24	CO	CC	35,10	23,20	4,4		
SP208-210/90	UC210G2	SPR2	SPR21	SPR22	SPR24	CO	CC	35,10	23,20	4,2	50	
SP208-210/90	US210G2	SPR2	SPR21	SPR22	SPR24	CO	CC	35,10	23,20	4,2		
SP208-210/90	ES210G2	SPR2	SPR21	SPR22	SPR24	COE	CCE	35,10	23,20	4,2		
SP208-210/90	EX210G2	SPR2	SPR21	SPR22	SPR24	COE	CCE	35,10	23,20	4,4		



→ Stretcher frame

SPR

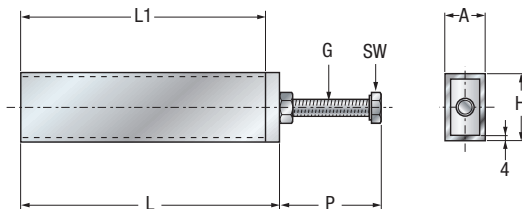
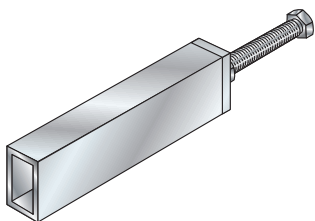

SPR1+2

d	Unit	Housing	Main dimensions [mm]					
			L	L1	H	H2	m	m1
	SPR1	SP203-207	190	180	50	-	-	-
	SPR2	SP208-210	225	210	70	-	-	-
	SPR11	SP203-207	190	180	50	100	130	80
	SPR21	SP208-210	225	210	70	140	160	100
	SPR12	SP203-207	190	180	48	100	65	75
	SPR22	SP208-210	225	210	68	130	80	100
	SPR14	SP203-207	190	180	48	103	140	80
	SPR24	SP208-210	235	220	68	130	180	100

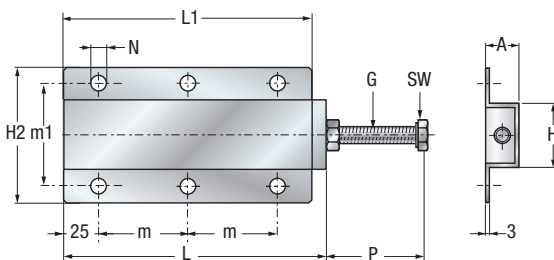
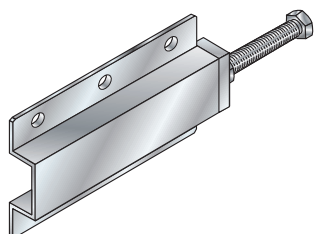

SPR12+22

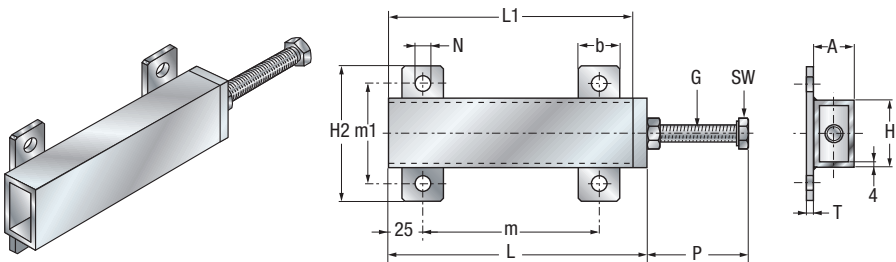

SPR11+21

Main dimensions [mm]

A	b	T	P _{max}	G	N	SW
30	-	-	85	M12x90	-	18
40	-	-	105	M16x110	-	24
30	30	5	85	M12x90	11,0	18
40	40	6	105	M16x110	14,0	24
25	-	-	85	M12x90	10,0	18
35	-	-	105	M16x110	12,0	24
25	-	-	97	M12x100	11,5	18
35	-	-	111	M16x120	14,0	24

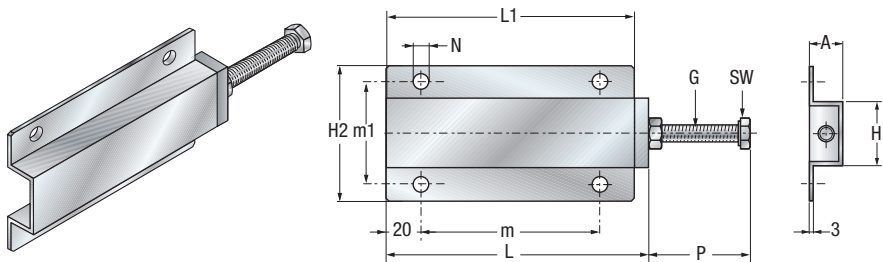

SPR14+24

→ Cartridge unit

C200
C300

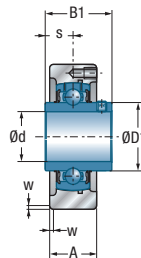
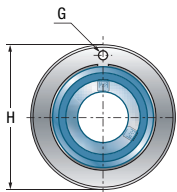
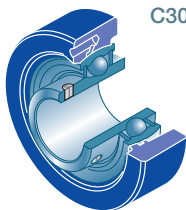

UCC200
UCC300

Main dimensions [mm]								
Shaft diameter	Unit	H h7	A	w	s1	B	B1	s
12	UCC201	72	20	1,5	-	-	31,0	12,7
	USC201	67	20	1,5	-	-	22,0	6,0
	ESC201	67	20	1,5	-	-	28,6	6,5
	EXC201	72	20	1,5	-	-	43,5	17,0
15	UCC202	72	20	1,5	-	-	31,0	12,7
	USC202	67	20	1,5	-	-	22,0	6,0
	ESC202	67	20	1,5	-	-	28,6	6,5
	EXC202	72	20	1,5	-	-	43,5	17,0
17	UCC203	72	20	1,5	-	-	31,0	12,7
	USC203	67	20	1,5	-	-	22,0	6,0
	ESC203	67	20	1,5	-	-	28,6	6,5
	EXC203	72	20	1,5	-	-	43,5	17,0
20	UCC204	72	20	1,5	-	-	31,0	12,7
	USC204	72	20	1,5	-	-	25,0	7,0
	ESC204	72	20	1,5	-	-	30,9	7,5
	EXC204	72	20	1,5	-	-	43,5	17,0
	UKC205H	80	22	1,5	18,5	35,0	-	-
	UKC305H	90	26	2,5	21,5	35,0	-	-
25	UCC205	80	22	1,5	-	-	34,0	14,3
	USC205	80	22	1,5	-	-	27,0	7,5
	ESC205	80	22	1,5	-	-	30,9	7,5
	EXC205	80	22	1,5	-	-	44,3	17,4
	UKC206H	85	27	1,5	20,5	38,0	-	-
	UCC305	90	26	2,5	-	-	38,0	15,0
	EXC305	90	26	2,5	-	-	46,8	16,7
	UKC306H	100	28	2,5	23,0	38,0	-	-
	UCC306	100	28	2,5	-	-	43,0	17,0
30	UCC206	85	27	1,5	-	-	38,1	15,9
	USC206	85	27	1,5	-	-	30,0	8,0
	ESC206	85	27	1,5	-	-	35,7	9,0
	EXC206	85	27	1,5	-	-	48,3	18,2
	UKC207H	90	28	2,0	22,5	43,0	-	-
	UCC306	100	28	2,5	-	-	43,0	17,0

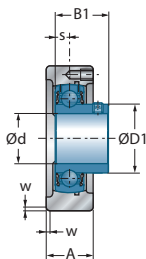

USC200

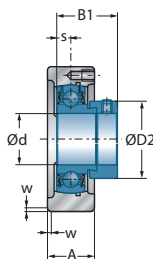

ESC200

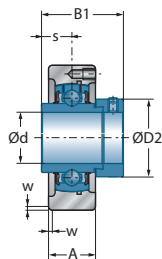

**EXC200
EXC300**

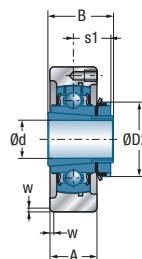

**UKC200H
UKC300H**

Main dimensions [mm]

Main dimensions [mm]			Housing	Bearing insert	Dynamic load rating		Static load rating	Weight	Shaft diameter
D1	D2	G			C_r [kN]	C_{0r} [kN]	kg	d mm	
29,0	-	M6x1	C204	UC201G2	12,80	6,65	0,5	12	
24,6	-	M6x1	C203	US201G2	9,55	4,78	0,4		
-	28,6	M6x1	C203	ES201G2	9,55	4,78	0,4		
-	33,3	M6x1	C204	EX201G2	12,80	6,65	0,6		
29,0	-	M6x1	C204	UC202G2	12,80	6,65	0,5	15	
24,6	-	M6x1	C203	US202G2	9,55	4,78	0,4		
-	28,6	M6x1	C203	ES202G2	9,55	4,78	0,4		
-	33,3	M6x1	C204	EX202G2	12,80	6,65	0,6		
29,0	-	M6x1	C204	UC203G2	12,80	6,65	0,5	17	
24,6	-	M6x1	C203	US203G2	9,55	4,78	0,4		
-	28,6	M6x1	C203	ES203G2	9,55	4,78	0,4		
-	33,3	M6x1	C204	EX203G2	12,80	6,65	0,6		
29,0	-	M6x1	C204	UC204G2	12,80	6,65	0,5	20	
29,0	-	M6x1	C204	US204G2	12,80	6,65	0,5		
-	33,3	M6x1	C204	ES204G2	12,80	6,65	0,5		
-	33,3	M6x1	C204	EX204G2	12,80	6,65	0,5		
-	38,0	M6x1	C205	UK205G2H	14,00	7,88	0,7		
35,4	38,0	M6x1	C305	UK305G2H	22,36	11,50	1,5		
34,0	-	M6x1	C205	UC205G2	14,00	7,88	0,7	25	
34,0	-	M6x1	C205	US205G2	14,00	7,88	0,7		
-	38,1	M6x1	C205	ES205G2	14,00	7,88	0,7		
-	38,1	M6x1	C205	EX205G2	14,00	7,88	0,7		
-	45,0	M6x1	C206	UK206G2H	19,50	11,20	1,0		
35,4	-	M6x1	C305	UC305G2	22,36	11,50	1,4		
-	42,8	M6x1	C305	EX305G2	22,36	11,50	1,4		
-	45,0	M6x1	C306	UK306G2H	27,00	15,20	1,7		
40,3	-	M6x1	C206	UC206G2	19,50	11,20	1,0	30	
40,3	-	M6x1	C206	US206G2	19,50	11,20	0,9		
-	44,5	M6x1	C206	ES206G2	19,50	11,20	1,0		
-	44,5	M6x1	C206	EX206G2	19,50	11,20	1,1		
-	52,0	M6x1	C207	UK207G2H	25,70	15,20	1,1		
44,6	-	M6x1	C306	UC306G2	27,00	15,20	1,7		



→ Cartridge unit

C200
C300

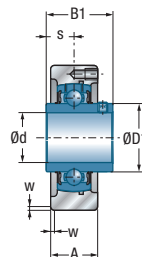
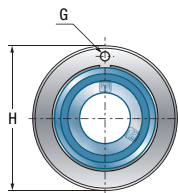
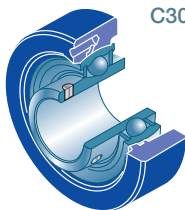

UCC200
UCC300

Shaft diameter		Main dimensions [mm]						
d mm	Unit	H h7	A	w	s1	B	B1	s
30	EXC306	100	28	2,5	-	-	50,0	17,5
	UKC307H	110	32	3,0	25,5	43,0	-	-
35	UCC207	90	28	2,0	-	-	42,9	17,5
	USC207	90	28	2,0	-	-	32,0	8,5
	ESC207	90	28	2,0	-	-	38,9	9,5
	EXC207	90	28	2,0	-	-	51,1	18,8
	UKC208H	100	30	2,0	24,5	46,0	-	-
	UCC307	110	32	3,0	-	-	48,0	19,0
	EXC307	110	32	3,0	-	-	51,6	18,3
	UKC308H	120	34	3,0	27,5	46,0	-	-
40	UCC208	100	30	2,0	-	-	49,2	19,0
	USC208	100	30	2,0	-	-	34,0	9,0
	ESC208	100	30	2,0	-	-	43,7	11,0
	EXC208	100	30	2,0	-	-	56,3	21,4
	UKC209H	110	31	2,0	26,0	50,0	-	-
	UCC308	120	34	3,0	-	-	52,0	19,0
	EXC308	120	34	3,0	-	-	57,1	19,8
	UKC309H	130	38	3,5	30,0	50,0	-	-
45	UCC209	110	31	2,0	-	-	49,2	19,0
	USC209	110	31	2,0	-	-	41,2	10,2
	ESC209	110	31	2,0	-	-	43,7	11,0
	EXC209	110	31	2,0	-	-	56,3	21,4
	UKC210H	120	33	2,0	27,5	55,0	-	-
	UCC309	130	38	3,5	-	-	57,0	22,0
	EXC309	130	38	3,5	-	-	58,7	19,8
	UKC310H	140	40	3,5	32,0	55,0	-	-
50	UCC210	120	33	2,0	-	-	51,6	19,0
	USC210	120	33	2,0	-	-	43,5	10,9
	ESC210	120	33	2,0	-	-	43,7	11,0
	EXC210	120	33	2,0	-	-	62,7	24,6
	UKC211H	125	35	2,5	29,0	59,0	-	-
	UCC310	140	40	3,5	-	-	61,0	22,0

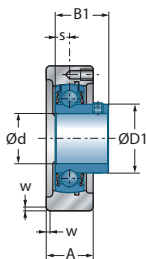

USC200

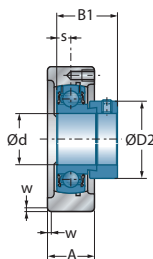

ESC200

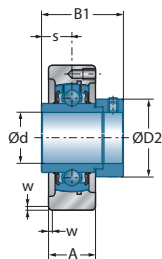

EXC200
EXC300

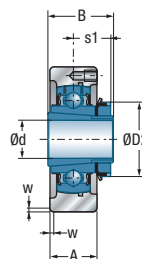

UKC200H
UKC300H

Main dimensions [mm]

Main dimensions [mm]			Housing	Bearing insert	Dynamic load rating	Static load rating	Weight	Shaft diameter
D1	D2	G			C_r [kN]	C_{0r} [kN]	kg	d mm
-	50,0	M6x1	C306	EX306G2	27,00	15,20	1,8	30
-	52,0	M6x1	C307	UK307G2H	33,50	19,20	1,9	
48,0	-	M6x1	C207	UC207G2	25,70	15,20	1,1	35
48,0	-	M6x1	C207	US207G2	25,70	15,20	1,0	
-	55,6	M6x1	C207	ES207G2	25,70	15,20	1,1	
-	55,6	M6x1	C207	EX207G2	25,70	15,20	1,2	
-	58,0	M6x1	C208	UK208G2H	29,60	18,20	1,4	
48,9	-	M6x1	C307	UC307G2	33,50	19,20	1,7	
-	55,0	M6x1	C307	EX307G2	33,50	19,20	1,8	
-	58,0	M6x1	C308	UK308G2H	40,56	24,00	2,1	
53,0	-	M6x1	C208	UC208G2	29,60	18,20	1,3	
53,0	-	M6x1	C208	US208G2	29,60	18,20	1,3	
-	60,3	M6x1	C208	ES208G2	29,60	18,20	1,4	
-	60,3	M6x1	C208	EX208G2	29,60	18,20	1,5	
-	65,0	M6x1	C209	UK209G2H	31,85	20,80	1,6	
56,5	-	M6x1	C308	UC308G2	40,56	24,00	2,1	
-	63,5	M6x1	C308	EX308G2	40,56	24,00	2,2	
-	65,0	M6x1	C309	UK309G2H	53,00	31,80	3,1	
57,2	-	M6x1	C209	UC209G2	31,85	20,80	1,5	45
57,2	-	M6x1	C209	US209G2	31,85	20,80	1,5	
-	63,5	M6x1	C209	ES209G2	31,85	20,80	1,5	
-	63,5	M6x1	C209	EX209G2	31,85	20,80	1,7	
-	70,0	M6x1	C210	UK210G2H	35,10	23,20	2,1	
61,8	-	M6x1	C309	UC309G2	53,00	31,80	2,9	
-	70,0	M6x1	C309	EX309G2	53,00	31,80	3,1	
-	70,0	M6x1	C310	UK310G2H	62,00	37,80	3,3	
61,8	-	M6x1	C210	UC210G2	35,10	23,20	1,9	
61,8	-	M6x1	C210	US210G2	35,10	23,20	1,9	
-	69,9	M6x1	C210	ES210G2	35,10	23,20	1,9	
-	69,9	M6x1	C210	EX210G2	35,10	23,20	2,1	
-	75,0	M6x1	C211	UK211G2H	43,55	29,20	2,3	
68,7	-	M6x1	C310	UC310G2	62,00	37,80	3,3	



→ Cartridge unit

C200
C300

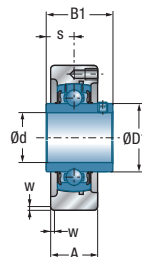
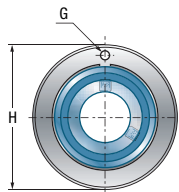
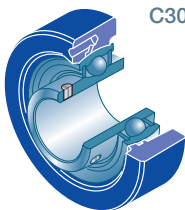

UCC200
UCC300

Shaft diameter		Main dimensions [mm]							
d mm	Unit	H h7	A	w	s1	B	B1	s	
50	EXC310	140	40	3,5	-	-	66,6	24,6	
	UKC311H	150	44	3,5	34,0	59,0	-	-	
55	UCC211	125	35	2,5	-	-	55,6	22,2	
	USC211	125	35	2,5	-	-	45,3	11,8	
	ESC211	125	35	2,5	-	-	48,4	12,0	
	EXC211	125	35	2,5	-	-	71,3	27,7	
	UKC212H	130	38	2,5	31,0	62,0	-	-	
	UCC311	150	44	3,5	-	-	66,0	25,0	
	EXC311	150	44	3,5	-	-	73,0	27,8	
	UKC312H	160	46	3,5	36,5	62,0	-	-	
60	UCC212	130	38	2,5	-	-	65,1	25,4	
	USC212	130	38	2,5	-	-	53,7	14,9	
	ESC212	130	38	2,5	-	-	49,3	12,0	
	EXC212	130	38	2,5	-	-	77,7	30,9	
	UKC213H	140	40	2,5	32,0	65,0	-	-	
	UCC312	160	46	3,5	-	-	71,0	26,0	
	EXC312	160	46	3,5	-	-	79,4	31,0	
	UKC313H	170	50	3,5	38,5	65,0	-	-	
65	UCC213	140	40	2,5	-	-	65,1	25,4	
	EXC213	140	40	2,5	-	-	85,7	34,1	
	UKC215H	160	44	2,0	35,5	73,0	-	-	
	UCC313	170	50	3,5	-	-	75,0	30,0	
	EXC313	170	50	3,5	-	-	85,7	32,5	
	UKC315H	190	55	4,0	42,5	73,0	-	-	
70	UCC214	150	44	2,0	-	-	74,6	30,2	
	EXC214	150	44	2,0	-	-	85,7	34,1	
	UKC216H	170	48	2,0	39,0	78,0	-	-	
	UCC314	180	52	4,0	-	-	78,0	33,0	
	EXC314	180	52	4,0	-	-	92,1	34,2	
	UKC316H	200	60	4,0	44,5	78,0	-	-	
75	UCC215	160	44	2,0	-	-	77,8	33,3	
	EXC215	160	44	2,0	-	-	92,1	37,3	

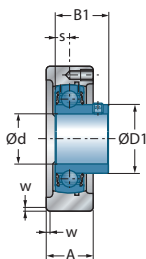

USC200

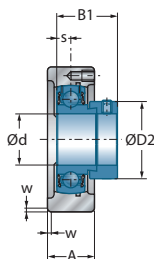

ESC200

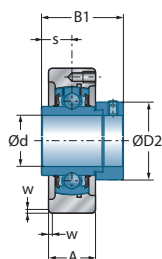

EXC200
EXC300

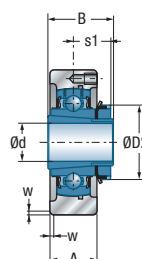

UKC200H
UKC300H

Main dimensions [mm]

Main dimensions [mm]			Housing	Bearing insert	Dynamic load rating	Static load rating	Weight	Shaft diameter
D1	D2	G			C_r [kN]	C_{0r} [kN]	kg	d mm
-	76,2	M6x1	C310	EX310G2	62,00	37,80	3,5	50
-	75,0	M6x1	C311	UK311G2H	71,50	44,80	4,2	
69,0	-	M6x1	C211	UC211G2	43,55	29,20	2,3	55
69,0	-	M6x1	C211	US211G2	43,55	29,20	2,2	
-	76,2	M6x1	C211	ES211G2	43,55	29,20	2,0	
-	76,2	M6x1	C211	EX211G2	43,55	29,20	2,5	
-	80,0	M6x1	C212	UK212G2H	52,50	32,80	2,7	
74,9	-	M6x1	C311	UC311G2	71,50	44,80	3,9	
-	83,0	M6x1	C311	EX311G2	71,50	44,80	4,3	
-	80,0	M6x1	C312	UK312G2H	81,60	51,80	4,6	
74,9	-	M6x1	C212	UC212G2	52,50	32,80	2,7	60
74,9	-	M6x1	C212	US212G2	52,50	32,80	2,5	
-	84,2	M6x1	C212	ES212G2	52,50	32,80	2,4	
-	84,2	M6x1	C212	EX212G2	52,50	32,80	3,1	
-	85,0	M6x1	C213	UK213G2H	57,20	40,00	3,2	
81,0	-	M6x1	C312	UC312G2	81,60	51,80	4,7	
-	89,0	M6x1	C312	EX312G2	81,60	51,80	5,0	
-	85,0	M6x1	C313	UK313G2H	93,86	60,50	5,7	
82,0	-	M6x1	C213	UC213G2	57,20	40,00	3,2	65
-	86,0	M6x1	C213	EX213G2	57,20	40,00	3,7	
-	98,0	M6x1	C215	UK215G2H	66,00	49,50	4,0	
87,5	-	M6x1	C313	UC313G2	93,86	60,50	5,7	
-	97,0	M6x1	C313	EX313G2	93,86	60,50	6,1	
-	98,0	M10x1	C315	UK315G2H	113,36	76,80	9,0	
-	98,0	M10x1	C315	UK315G2H	113,36	76,80	9,0	
86,5	-	M6x1	C214	UC214G2	62,00	45,00	5,3	70
-	96,8	M6x1	C214	EX214G2	62,00	45,00	5,8	
-	105,0	M6x1	C216	UK216G2H	72,50	54,20	6,8	
94,0	-	M10x1	C314	UC314G2	104,26	68,00	8,0	
-	102,0	M10x1	C314	EX314G2	104,26	68,00	8,5	
-	105,0	M10x1	C316	UK316G2H	122,85	86,50	9,8	
91,5	-	M6x1	C215	UC215G2	66,00	49,50	5,6	75
-	102,0	M6x1	C215	EX215G2	66,00	49,50	6,2	



→ Cartridge unit

C200
C300

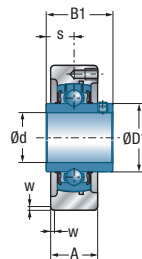
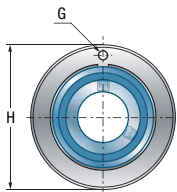
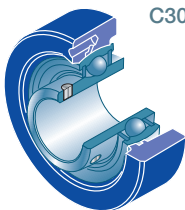

UCC200
UCC300

Shaft diameter		Main dimensions [mm]						
d mm	Unit	H h7	A	w	s1	B	B1	s
75	UCC315	190	55	4,0	-	-	82,0	32,0
	EXC315	190	55	4,0	-	-	100,0	37,3
	UKC317H	215	64	4,0	48,0	82,0	-	-
80	UCC216	170	48	2,0	-	-	82,6	33,3
	EXC216	170	48	2,0	-	-	95,2	37,3
	UCC316	200	60	4,0	-	-	86,0	34,0
	EXC316	200	60	4,0	-	-	106,4	40,5
85	UKC318H	225	66	4,0	48,0	86,0	-	-
	UCC317	215	64	4,0	-	-	96,0	40,0
	EXC317	215	64	4,0	-	-	109,5	42,0
90	UKC319H	240	72	4,0	52,0	90,0	-	-
	UCC318	225	66	4,0	-	-	96,0	40,0
	EXC318	225	66	4,0	-	-	115,9	43,6
95	UKC320H	260	75	4,0	54,0	97,0	-	-
	UCC319	240	72	4,0	-	-	103,0	41,0
	EXC319	240	72	4,0	-	-	122,3	46,8
100	UCC320	260	75	4,0	-	-	108,0	42,0
	EXC320	260	75	4,0	-	-	128,6	50,0
	UKC322H	300	80	5,0	61,0	105,0	-	-
105	UCC321	260	75	4,0	-	-	112,0	44,0
110	UCC322	300	80	5,0	-	-	117,0	46,0
	UKC324H	320	90	5,0	65,0	112,0	-	-
115	UKC326H	340	100	5,0	69,0	121,0	-	-
120	UCC324	320	90	5,0	-	-	126,0	51,0
125	UKC328H	360	100	5,0	73,0	131,0	-	-
130	UCC326	340	100	5,0	-	-	135,0	54,0
140	UCC328	360	100	5,0	-	-	145,0	59,0

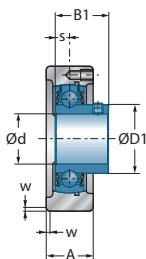

USC200

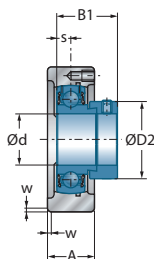

ESC200

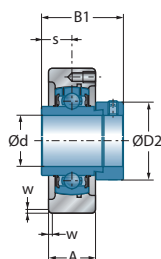

EXC200
EXC300

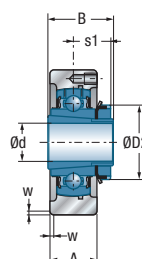

UKC200H
UKC300H

Main dimensions [mm]

Main dimensions [mm]			Housing	Bearing insert	Dynamic load rating	Static load rating	Weight	Shaft diameter
D1	D2	G			C_r [kN]	C_{0r} [kN]	kg	d mm
100,5	-	M10x1	C315	UC315G2	113,36	76,80	8,3	75
-	113,0	M10x1	C315	EX315G2	113,36	76,80	9,3	
-	110,0	M10x1	C317	UK317G2H	132,60	96,50	11,4	
98,0	-	M6x1	C216	UC216G2	72,50	54,20	6,4	80
-	110,0	M6x1	C216	EX216G2	72,50	54,20	6,7	
107,9	-	M10x1	C316	UC316G2	122,85	86,50	9,6	
-	119,0	M10x1	C316	EX316G2	122,85	86,50	10,7	
-	120,0	M10x1	C318	UK318G2H	143,00	108,00	12,9	
114,0	-	M10x1	C317	UC317G2	132,60	96,50	11,3	85
-	127,0	M10x1	C317	EX317G2	132,60	96,50	12,5	
-	125,0	M10x1	C319	UK319G2H	156,00	122,00	16,2	
120,0	-	M10x1	C318	UC318G2	143,00	108,00	12,9	90
-	133,0	M10x1	C318	EX318G2	143,00	108,00	14,1	
-	130,0	M10x1	C320	UK320G2H	171,60	140,00	19,0	
126,5	-	M10x1	C319	UC319G2	156,00	122,00	15,9	95
-	140,0	M10x1	C319	EX319G2	156,00	122,00	17,4	
134,5	-	M10x1	C320	UC320G2	171,60	140,00	19,2	100
-	146,0	M10x1	C320	EX320G2	171,60	140,00	21,0	
-	145,0	M10x1	C322	UK322G2H	205,00	178,00	31,6	
140,5	-	M10x1	C321	UC321G2	182,00	155,00	20,2	105
149,0	-	M10x1	C322	UC322G2	205,00	178,00	28,3	110
-	155,0	M10x1	C324	UK324G2H	228,00	208,00	36,2	
-	165,0	M10x1	C326	UK326G2H	252,00	242,00	43,9	115
163,0	-	M10x1	C324	UC324G2	228,00	208,00	33,5	120
-	180,0	M10x1	C328	UK328G2H	275,00	272,00	51,5	125
177,0	-	M10x1	C326	UC326G2	252,00	242,00	39,0	130
190,0	-	M10x1	C328	UC328G2	275,00	272,00	45,5	140



→ Hanger unit

EHE200

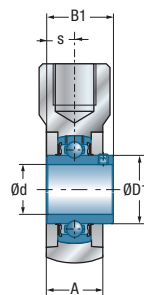
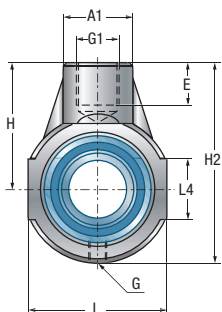
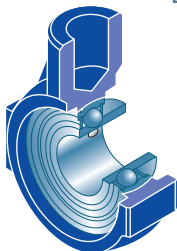

UCEHE200

Shaft diameter		Unit		Main dimensions [mm]										
d mm		H	L -0,5	H2	A	A1	L4	E	G1	s1	B	B1	s	
12	UCEHE201	58	65	91	25	30	38	21	M16	-	-	31,0	12,7	
	USEHE201	58	65	91	25	30	38	21	M16	-	-	22,0	6,0	
	ESEHE201	58	65	91	25	30	38	21	M16	-	-	28,6	6,5	
	EXEHE201	58	65	91	25	30	38	21	M16	-	-	43,5	17,0	
15	UCEHE202	58	65	91	25	30	38	21	M16	-	-	31,0	12,7	
	USEHE202	58	65	91	25	30	38	21	M16	-	-	22,0	6,0	
	ESEHE202	58	65	91	25	30	38	21	M16	-	-	28,6	6,5	
	EXEHE202	58	65	91	25	30	38	21	M16	-	-	43,5	17,0	
17	UCEHE203	58	65	91	25	30	38	21	M16	-	-	31,0	12,7	
	USEHE203	58	65	91	25	30	38	21	M16	-	-	22,0	6,0	
	ESEHE203	58	65	91	25	30	38	21	M16	-	-	28,6	6,5	
	EXEHE203	58	65	91	25	30	38	21	M16	-	-	43,5	17,0	
20	UCEHE204	58	65	91	25	30	38	21	M16	-	-	31,0	12,7	
	USEHE204	58	65	91	25	30	38	21	M16	-	-	25,0	7,0	
	ESEHE204	58	65	91	25	30	38	21	M16	-	-	30,9	7,5	
	EXEHE204	58	65	91	25	30	38	21	M16	-	-	43,5	17,0	
	UKEHE205H	64	70	99	28	35	38	22	M20	18,5	35,0	-	-	
25	UCEHE205	64	70	99	28	35	38	22	M20	-	-	34,0	14,3	
	USEHE205	64	70	99	28	35	38	22	M20	-	-	27,0	7,5	
	ESEHE205	64	70	99	28	35	38	22	M20	-	-	30,9	7,5	
	EXEHE205	64	70	99	28	35	38	22	M20	-	-	44,3	17,4	
	UKEHE206H	72	85	114	32	40	40	24	M24	20,5	38,0	-	-	
30	UCEHE206	72	85	114	32	40	40	24	M24	-	-	38,1	15,9	
	USEHE206	72	85	114	32	40	40	24	M24	-	-	30,0	8,0	
	ESEHE206	72	85	114	32	40	40	24	M24	-	-	35,7	9,0	
	EXEHE206	72	85	114	32	40	40	24	M24	-	-	48,3	18,2	
	UKEHE207H	76	90	122	32	40	40	24	M24	22,5	43,0	-	-	
35	UCEHE207	76	90	122	32	40	40	24	M24	-	-	42,9	17,5	
	USEHE207	76	90	122	32	40	40	24	M24	-	-	32,0	8,5	
	ESEHE207	76	90	122	32	40	40	24	M24	-	-	38,9	9,5	
	EXEHE207	76	90	122	32	40	40	24	M24	-	-	51,1	18,8	
	UKEHE208H	85	100	135	36	40	45	24	M24	24,5	46,0	-	-	

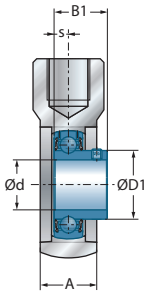

USEHE200

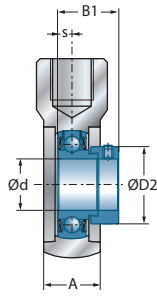

ESEHE200

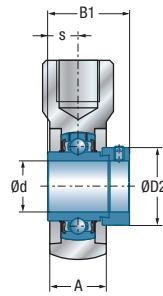

EXEHE200

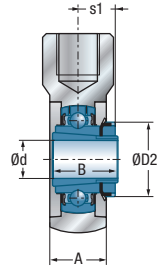

UKEHE200H

Main dimensions [mm]

Main dimensions [mm]			Housing	Bearing insert	Dynamic load rating	Static load rating	Weight	Shaft diameter
D1	D2	G			C_r [kN]	C_{0r} [kN]	kg	d mm
29,0	-	R1/8"	EHE204	UC201G2	12,80	6,65	0,8	12
24,6	-	M6x1	EHE203	US201G2	9,55	4,78	0,4	
-	28,6	M6x1	EHE203	ES201G2	9,55	4,78	0,5	
-	33,3	R1/8"	EHE204	EX201G2	12,80	6,65	0,8	
29,0	-	R1/8"	EHE204	UC202G2	12,80	6,65	0,8	15
24,6	-	M6x1	EHE203	US202G2	9,55	4,78	0,4	
-	28,6	M6x1	EHE203	ES202G2	9,55	4,78	0,5	
-	33,3	R1/8"	EHE204	EX202G2	12,80	6,65	0,8	
29,0	-	R1/8"	EHE204	UC203G2	12,80	6,65	0,5	17
24,6	-	M6x1	EHE203	US203G2	9,55	4,78	0,5	
-	28,6	M6x1	EHE203	ES203G2	9,55	4,78	0,5	
-	33,3	R1/8"	EHE204	EX203G2	12,80	6,65	0,8	
29,0	-	R1/8"	EHE204	UC204G2	12,80	6,65	0,7	20
29,0	-	R1/8"	EHE204	US204G2	12,80	6,65	0,7	
-	33,3	R1/8"	EHE204	ES204G2	12,80	6,65	0,7	
-	33,3	R1/8"	EHE204	EX204G2	12,80	6,65	0,8	
-	38,0	R1/8"	EHE205	UK205G2H	14,00	7,88	1,2	
34,0	-	R1/8"	EHE205	UC205G2	14,00	7,88	1,2	25
34,0	-	R1/8"	EHE205	US205G2	14,00	7,88	1,1	
-	38,1	R1/8"	EHE205	ES205G2	14,00	7,88	1,1	
-	38,1	R1/8"	EHE205	EX205G2	14,00	7,88	1,2	
-	45,0	R1/8"	EHE206	UK206G2H	19,50	11,20	1,4	
40,3	-	R1/8"	EHE206	UC206G2	19,50	11,20	1,3	30
40,3	-	R1/8"	EHE206	US206G2	19,50	11,20	1,3	
-	44,5	R1/8"	EHE206	ES206G2	19,50	11,20	1,3	
-	44,5	R1/8"	EHE206	EX206G2	19,50	11,20	1,4	
-	52,0	R1/8"	EHE207	UK207G2H	25,70	15,20	1,6	
48,0	-	R1/8"	EHE207	UC207G2	25,70	15,20	1,6	35
48,0	-	R1/8"	EHE207	US207G2	25,70	15,20	1,5	
-	55,6	R1/8"	EHE207	ES207G2	25,70	15,20	1,6	
-	55,6	R1/8"	EHE207	EX207G2	25,70	15,20	1,7	
-	58,0	R1/8"	EHE208	UK208G2H	29,60	18,20	1,9	



→ Hanger unit

EHE200

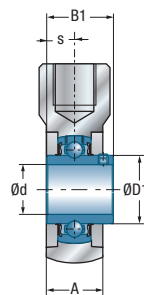
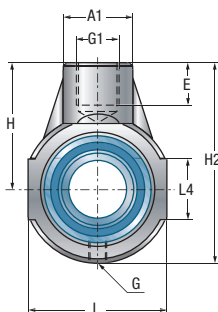
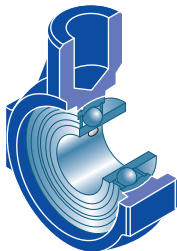

UCEHE200

Shaft diameter		Unit		Main dimensions [mm]									
d mm		H	L -0,5	H2	A	A1	L4	E	G1	s1	B	B1	s
40	UCEHE208	85	100	135	36	40	45	24	M24	-	-	49,2	19,0
	USEHE208	85	100	135	36	40	45	24	M24	-	-	34,0	9,0
	ESEHE208	85	100	135	36	40	45	24	M24	-	-	43,7	11,0
	EXEHE208	85	100	135	36	40	45	24	M24	-	-	56,3	21,4
	UKEHE209H	90	110	145	40	40	45	24	M24	26,0	50,0	-	-
45	UCEHE209	90	110	145	40	40	45	24	M24	-	-	49,2	19,0
	USEHE209	90	110	145	40	40	45	24	M24	-	-	41,2	10,2
	ESEHE209	90	110	145	40	40	45	24	M24	-	-	43,7	11,0
	EXEHE209	90	110	145	40	40	45	24	M24	-	-	56,3	21,4
	UKEHE210H	90	110	145	40	40	46	24	M24	27,5	55,0	-	-
50	UCEHE210	90	110	145	40	40	46	24	M24	-	-	51,6	19,0
	USEHE210	90	110	145	40	40	46	24	M24	-	-	43,5	10,9
	ESEHE210	90	110	145	40	40	46	24	M24	-	-	43,7	11,0
	EXEHE210	90	110	145	40	40	46	24	M24	-	-	62,7	24,6

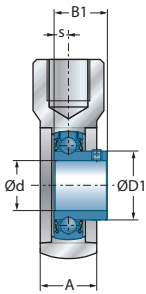

USEHE200

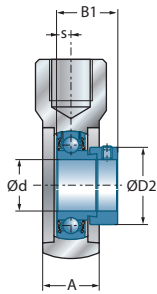

ESEHE200

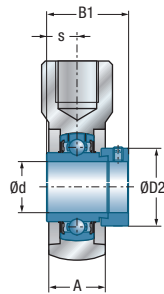

EXEHE200

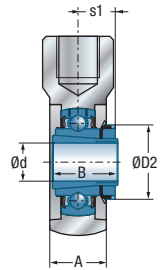

UKEHE200H

Main dimensions [mm]

Main dimensions [mm]			Housing	Bearing insert	Dynamic load rating	Static load rating	Weight	Shaft diameter
D1	D2	G			C_r [kN]	C_{0r} [kN]	kg	d mm
53,0	-	R1/8"	EHE208	UC208G2	29,60	18,20	1,8	40
53,0	-	R1/8"	EHE208	US208G2	29,60	18,20	1,8	
-	60,3	R1/8"	EHE208	ES208G2	29,60	18,20	1,9	
-	60,3	R1/8"	EHE208	EX208G2	29,60	18,20	2,0	
-	65,0	R1/8"	EHE209	UK209G2H	31,85	20,80	2,0	
57,2	-	R1/8"	EHE209	UC209G2	31,85	20,80	1,9	45
57,2	-	R1/8"	EHE209	US209G2	31,85	20,80	1,9	
-	63,5	R1/8"	EHE209	ES209G2	31,85	20,80	1,9	
-	63,5	R1/8"	EHE209	EX209G2	31,85	20,80	2,1	
-	70,0	R1/8"	EHE210	UK210G2H	35,10	23,20	2,2	
61,8	-	R1/8"	EHE210	UC210G2	35,10	23,20	2,0	50
61,8	-	R1/8"	EHE210	US210G2	35,10	23,20	2,0	
-	69,9	R1/8"	EHE210	ES210G2	35,10	23,20	2,0	
-	69,9	R1/8"	EHE210	EX210G2	35,10	23,20	2,2	



→ Pillow block unit

PP200

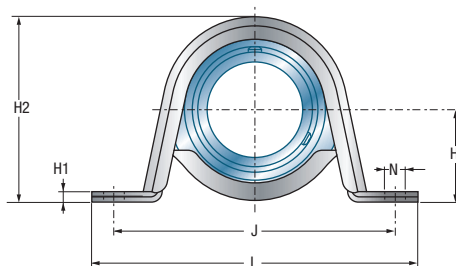
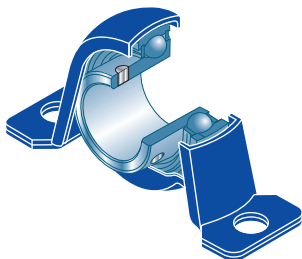

Shaft diameter		Unit		Main dimensions [mm]							
d mm		L	H	H1	H2	A	A1	J	N	B1	
12	USPP201	85,7	22,2	2,4	43,2	25,4	15,9	68	9	22,0	
	ESPP201	85,7	22,2	2,4	43,2	25,4	15,9	68	9	28,6	
15	USPP202	85,7	22,2	2,4	43,2	25,4	15,9	68	9	22,0	
	ESPP202	85,7	22,2	2,4	43,2	25,4	15,9	68	9	28,6	
17	USPP203	85,7	22,2	2,4	43,2	25,4	15,9	68	9	22,0	
	ESPP203	85,7	22,2	2,4	43,2	25,4	15,9	68	9	28,6	
20	USPP204	98,4	25,4	2,4	49,9	31,7	21,6	76	9	25,0	
	ESPP204	98,4	25,4	2,4	49,9	31,7	21,6	76	9	30,9	
25	USPP205	108,0	28,6	2,8	55,8	31,7	21,6	86	11	27,0	
	ESPP205	108,0	28,6	2,8	55,8	31,7	21,6	86	11	30,9	
30	USPP206	117,5	33,3	3,6	65,7	37,5	25,5	95	11	30,0	
	ESPP206	117,5	33,3	3,6	65,7	37,5	25,5	95	11	35,7	
35	USPP207	128,6	39,7	4,4	77,5	41,0	28,4	106	11	32,0	
	ESPP207	128,6	39,7	4,4	77,5	41,0	28,4	106	11	38,9	
40	USPP208	148,0	43,5	5,0	86,0	43,0	29,0	120	14	34,0	
	ESPP208	148,0	43,5	5,0	86,0	43,0	29,0	120	14	30,2	

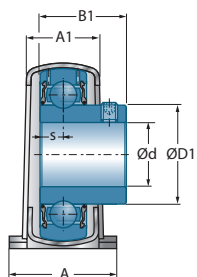

USPP200

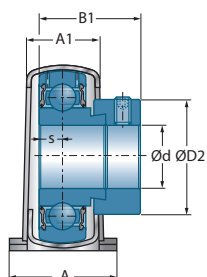

ESPP200

Main dimensions [mm]			Housing	Bearing insert	Dynamic load rating	Static load rating	Weight	Shaft diameter
s	D1	D2			C_r [kN]	C_{0r} [kN]	kg	d mm
6,0	24,6	-	PP203	US201G2	9,55	4,78	0,2	12
6,5	-	28,6	PP203	ES201G2	9,55	4,78	0,2	
6,0	24,6	-	PP203	US202G2	9,55	4,78	0,2	15
6,5	-	28,6	PP203	ES202G2	9,55	4,78	0,2	
6,0	24,6	-	PP203	US203G2	9,55	4,78	0,2	17
6,5	-	28,6	PP203	ES203G2	9,55	4,78	0,2	
7,0	29,0	-	PP204	US204G2	12,80	6,65	0,2	20
7,5	-	33,3	PP204	ES204G2	12,80	6,65	0,3	
7,5	34,0	-	PP205	US205G2	14,00	7,88	0,4	25
7,5	-	38,1	PP205	ES205G2	14,00	7,88	0,4	
8,0	40,3	-	PP206	US206G2	19,50	11,20	0,6	30
9,0	-	44,5	PP206	ES206G2	19,50	11,20	0,6	
8,5	48,0	-	PP207	US207G2	25,70	15,20	0,9	35
9,5	-	55,6	PP207	ES207G2	25,70	15,20	1,0	
9,0	53,0	-	PP208	US208G2	29,6	18,2	1,1	40
11,0	-	60,3	PP208	ES208G2	29,6	18,2	1,2	



→ Three-bolt flanged unit

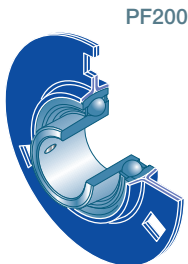

PF200

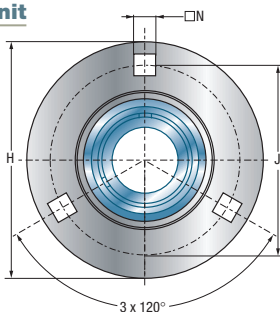

PF203...207

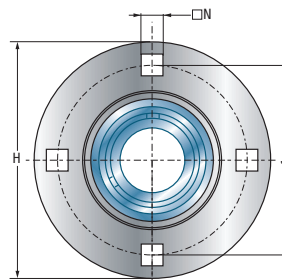

PF208...212

Shaft diameter		Unit		Main dimensions [mm]					
d mm		H	J	J2	A	A1	N	B1	
12	USPF201	81,0	63,5	49,0	6,7	4,0	7,1	22,0	
	ESPF201	81,0	63,5	49,0	6,7	4,0	7,1	28,6	
15	USPF202	81,0	63,5	49,0	6,7	4,0	7,1	22,0	
	ESPF202	81,0	63,5	49,0	6,7	4,0	7,1	28,6	
17	USPF203	81,0	63,5	49,0	6,7	4,0	7,1	22,0	
	ESPF203	81,0	63,5	49,0	6,7	4,0	7,1	28,6	
20	USPF204	90,5	71,5	55,0	7,7	4,0	8,7	25,0	
	ESPF204	90,5	71,5	55,0	7,7	4,0	8,7	30,9	
25	USPF205	95,2	76,0	60,0	8,7	4,0	8,7	27,0	
	ESPF205	95,2	76,0	60,0	8,7	4,0	8,7	30,9	
30	USPF206	112,7	90,5	71,0	9,0	5,0	10,5	30,0	
	ESPF206	112,7	90,5	71,0	9,0	5,0	10,5	35,7	
35	USPF207	122,2	100,0	81,0	10,0	5,0	10,5	32,0	
	ESPF207	122,2	100,0	81,0	10,0	5,0	10,5	38,9	
40	USPF208	147,8	119,0	91,0	10,0	7,0	13,5	34,0	
	ESPF208	147,8	119,0	91,0	10,0	7,0	13,5	43,7	
45	USPF209	149,2	120,5	97,0	10,0	7,0	13,5	41,2	
	ESPF209	149,2	120,5	97,0	10,0	7,0	13,5	43,7	
50	USPF210	155,6	127,0	102,0	10,5	8,0	13,5	43,5	
	ESPF210	155,6	127,0	102,0	10,5	8,0	13,5	43,7	
55	USPF211	166,6	138,0	113,0	10,7	8,0	13,5	45,3	
	ESPF211	166,6	138,0	113,0	10,7	8,0	13,5	48,4	
60	USPF212	176,2	147,6	122,0	11,9	8,0	13,5	53,7	
	ESPF212	176,2	147,6	122,0	11,9	8,0	13,5	49,3	

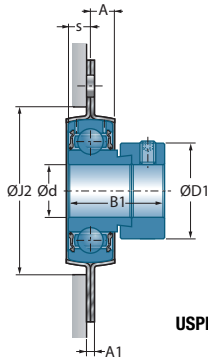

USPF200

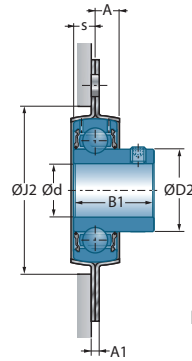

ESPF200

Main dimensions [mm]			Housing	Bearing insert	Dynamic load rating	Static load rating	Weight	Shaft diameter
s	D1	D2			C_r [kN]	C_{0r} [kN]	kg	d mm
6,0	24,6	-	PF203	US201G2	9,55	4,78	0,2	12
6,5	-	28,6	PF203	ES201G2	9,55	4,78	0,2	
6,0	24,6	-	PF203	US202G2	9,55	4,78	0,2	15
6,5	-	28,6	PF203	ES202G2	9,55	4,78	0,2	
6,0	24,6	-	PF203	US203G2	9,55	4,78	0,2	17
6,5	-	28,6	PF203	ES203G2	9,55	4,78	0,2	
7,0	29,0	-	PF204	US204G2	12,80	6,65	0,3	20
7,5	-	33,3	PF204	ES204G2	12,80	6,65	0,3	
7,5	34,0	-	PF205	US205G2	14,00	7,88	0,4	25
7,5	-	38,1	PF205	ES205G2	14,00	7,88	0,4	
8,0	40,3	-	PF206	US206G2	19,50	11,20	0,7	30
9,0	-	44,5	PF206	ES206G2	19,50	11,20	0,7	
8,5	48,0	-	PF207	US207G2	25,70	15,20	0,9	35
9,5	-	55,6	PF207	ES207G2	25,70	15,20	1,0	
9,0	53,0	-	PF208	US208G2	29,60	18,20	1,5	40
11,0	-	60,3	PF208	ES208G2	29,60	18,20	1,6	
10,2	57,2	-	PF209	US209G2	31,85	20,80	1,7	45
11,0	-	63,5	PF209	ES209G2	31,85	20,80	1,7	
10,9	61,8	-	PF210	US210G2	35,10	23,20	1,8	50
11,0	-	69,9	PF210	ES210G2	35,10	23,20	1,8	
11,8	69,0	-	PF211	US211G2	43,55	29,20	2,2	55
12,0	-	76,2	PF211	ES211G2	43,55	29,20	2,0	
14,9	74,9	-	PF212	US212G2	52,50	32,80	2,4	60
12,0	-	84,2	PF212	ES212G2	52,50	32,80	2,3	



→ Two-bolt flanged unit



PFL200

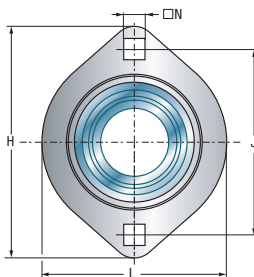

Shaft diameter		Unit		Main dimensions [mm]						
d mm		L	H	J	J2	A	A1	N	B1	
12	USPFL201	58,7	81,0	63,5	49,0	6,7	4,0	7,1	22,0	
	ESPFL201	58,7	81,0	63,5	49,0	6,7	4,0	7,1	28,6	
15	USPFL202	58,7	81,0	63,5	49,0	6,7	4,0	7,1	22,0	
	ESPFL202	58,7	81,0	63,5	49,0	6,7	4,0	7,1	28,6	
17	USPFL203	58,7	81,0	63,5	49,0	6,7	4,0	7,1	22,0	
	ESPFL203	58,7	81,0	63,5	49,0	6,7	4,0	7,1	28,6	
20	USPFL204	66,7	90,5	71,5	55,0	7,7	4,0	8,7	25,0	
	ESPFL204	66,7	90,5	71,5	55,0	7,7	4,0	8,7	30,9	
25	USPFL205	71,0	95,2	76,2	60,0	8,7	4,0	8,7	27,0	
	ESPFL205	71,0	95,2	76,2	60,0	8,7	4,0	8,7	30,9	
30	USPFL206	84,0	112,7	90,5	71,0	9,0	5,0	10,5	30,0	
	ESPFL206	84,0	112,7	90,5	71,0	9,0	5,0	10,5	35,7	
35	USPFL207	93,7	123,0	100,0	81,0	10,5	5,0	10,5	32,0	
	ESPFL207	93,7	123,0	100,0	81,0	10,5	5,0	10,5	38,9	
40	USPFL208	100,0	151,0	119,0	91,0	11,5	7,0	13,5	34,0	
	ESPFL208	100,0	151,0	119,0	91,0	11,5	7,0	13,5	43,7	

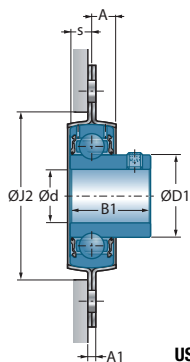

USPFL200

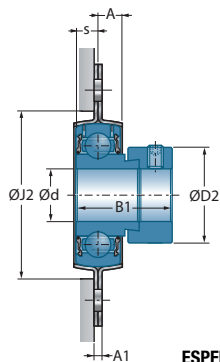

ESPFL200

Main dimensions [mm]			Housing	Bearing insert	Dynamic load rating	Static load rating	Weight	Shaft diameter
s	D1	D2			C_r [kN]	C_{0r} [kN]	kg	d mm
6,0	24,6	-	PFL203	US201G2	9,55	4,78	0,2	12
6,5	-	28,6	PFL203	ES201G2	9,55	4,78	0,2	
6,0	24,6	-	PFL203	US202G2	9,55	4,78	0,2	15
6,5	-	28,6	PFL203	ES202G2	9,55	4,78	0,2	
6,0	24,6	-	PFL203	US203G2	9,55	4,78	0,2	17
6,5	-	28,6	PFL203	ES203G2	9,55	4,78	0,2	
7,0	29,0	-	PFL204	US204G2	12,80	6,65	0,2	20
7,5	-	33,3	PFL204	ES204G2	12,80	6,65	0,3	
7,5	34,0	-	PFL205	US205G2	14,00	7,88	0,4	25
7,5	-	38,1	PFL205	ES205G2	14,00	7,88	0,4	
8,0	40,3	-	PFL206	US206G2	19,50	11,20	0,6	30
9,0	-	44,5	PFL206	ES206G2	19,50	11,20	0,6	
8,5	48,0	-	PFL207	US207G2	25,70	15,20	0,9	35
9,5	-	55,6	PFL207	ES207G2	25,70	15,20	1,0	
9,0	53,0	-	PFL208	US208G2	29,60	18,20	1,1	40
11,0	-	60,3	PFL208	ES208G2	29,60	18,20	1,2	



→ Three-bolt flanged unit-triangular

PFT200

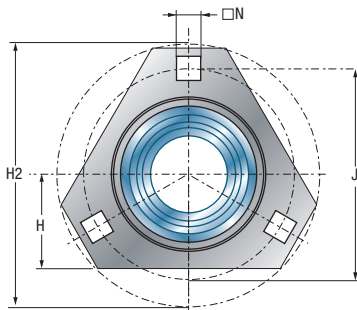
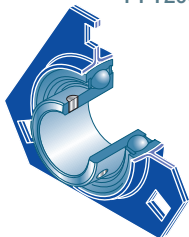

Shaft diameter		Unit		Main dimensions [mm]						
d mm		H	H2	J	J2	A	A1	N	B1	
20	USPFT204	33,3	90,5	71,5	55,0	7,2	4,0	8,7	25,0	
	ESPFT204	33,3	90,5	71,5	55,0	7,2	4,0	8,7	30,9	
25	USPFT205	34,2	95,2	76,0	60,0	8,7	4,0	8,7	27,0	
	ESPFT205	34,2	95,2	76,0	60,0	8,7	4,0	8,7	30,9	
30	USPFT206	40,2	112,7	90,5	71,0	10,5	5,0	10,5	30,0	
	ESPFT206	40,2	112,7	90,5	71,0	10,5	5,0	10,5	35,7	
35	USPFT207	44,2	122,2	100,0	81,0	10,5	5,0	10,5	32,0	
	ESPFT207	44,2	122,2	100,0	81,0	10,5	5,0	10,5	38,9	

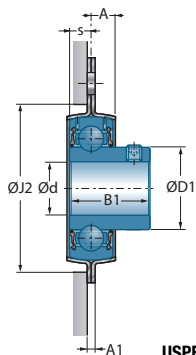

USPFT200

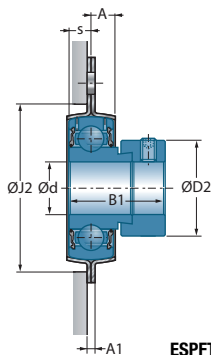

ESPFT200

Main dimensions [mm]			Housing	Bearing insert	Dynamic load rating	Static load rating	Weight	Shaft diameter
s	D1	D2			C_r [kN]	C_{0r} [kN]	kg	d mm
7,0	29,0	-	PFT204	US204G2	12,80	6,65	0,2	20
7,5	-	33,3	PFT204	ES204G2	12,80	6,65	0,3	
7,5	34,0	-	PFT205	US205G2	14,00	7,88	0,4	25
7,5	-	38,1	PFT205	ES205G2	14,00	7,88	0,4	
8,0	40,3	-	PFT206	US206G2	19,50	11,20	0,6	30
9,0	-	44,5	PFT206	ES206G2	19,50	11,20	0,6	
8,5	48,0	-	PFT207	US207G2	25,70	15,20	0,9	35
9,5	-	55,6	PFT207	ES207G2	25,70	15,20	1,0	



→ Take-up unit

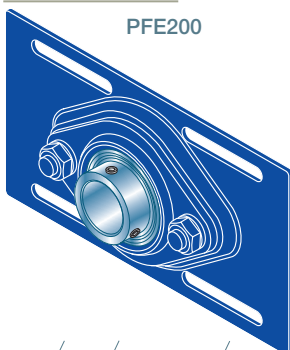

PFE200

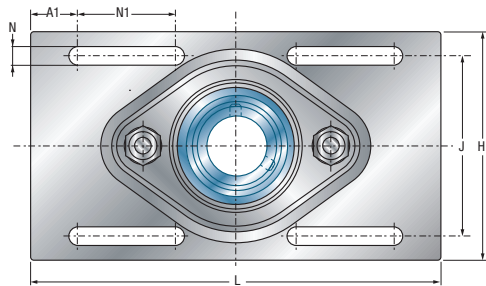

		Main dimensions [mm]										
Shaft diameter	Unit	L	H	J	A	A1	A2	e	N	N1	T	B1
25	USPFE205	203,2	104,8	80,2	19,0	23,4	29,8	10,3	8,7	48,5	2,0	27,0
	ESPFE205	203,2	104,8	80,2	19,0	23,4	33,7	10,3	8,7	48,5	2,0	30,9
30	USPFE206	203,2	114,3	89,2	21,1	23,4	34,1	12,1	8,7	48,5	2,5	30,0
	ESPFE206	203,2	114,3	89,2	21,1	23,4	38,8	12,1	8,7	48,5	2,5	35,7

The connecting bolts of the sheet metal parts are attached to the units

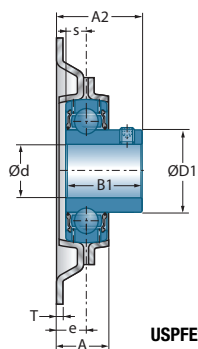

USPFE200

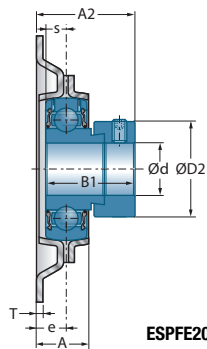

ESPFE200

Main dimensions [mm]			Housing	Bearing insert	Dynamic load rating	Static load rating	Weight	Shaft diameter
s	D1	D2			C_r [kN]	C_{0r} [kN]	kg	d mm
7,5	34,0	-	PFE205	US205G2	14,00	7,88	0,6	25
7,5	-	38,1	PFE205	ES205G2	14,00	7,88	0,6	
8,0	40,3	-	PFE206	US206G2	19,50	11,20	0,8	30
9,0	-	44,5	PFE206	ES206G2	19,50	11,20	0,9	



→ Bearing insert

with set screws
UC200

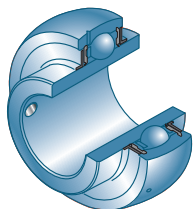

and extended sealing system
UC200L4

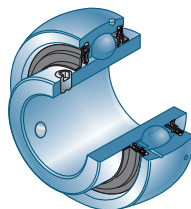

Shaft diameter	Bearing insert	Main dimensions [mm]					
		d mm	D	C	B1	s _{max}	D1
12	UC201G2	47,0	16,0	31,0	12,7	29,0	4,4
15	UC202G2	47,0	16,0	31,0	12,7	29,0	4,4
17	UC203G2	47,0	16,0	31,0	12,7	29,0	4,4
20	UC204G2	47,0	16,0	31,0	12,7	29,0	4,4
25	UC205G2	52,0	17,0	34,0	14,3	34,0	4,3
30	UC206G2	62,0	19,0	38,1	15,9	40,3	5,0
35	UC207G2	72,0	20,0	42,9	17,5	48,0	5,8
40	UC208G2	80,0	21,0	49,2	19,0	53,0	6,3
45	UC209G2	85,0	22,0	49,2	19,0	57,2	6,8
50	UC210G2	90,0	23,0	51,6	19,0	61,8	6,5
55	UC211G2	100,0	25,0	55,6	22,2	69,0	7,2
60	UC212G2	110,0	27,0	65,1	25,4	74,9	8,2
65	UC213G2	120,0	28,0	65,1	25,4	82,0	8,0
70	UC214G2	125,0	30,0	74,6	30,2	86,5	9,0
75	UC215G2	130,0	30,0	77,8	33,3	91,5	9,0
80	UC216G2	140,0	33,0	82,6	33,3	98,0	10,3
85	UC217G2	150,0	35,0	85,7	34,1	105,1	11,0
90	UC218G2	160,0	37,0	96,0	39,7	111,0	12,0

12	UC201G2L4	47,0	16,0	31,0	12,7	29,0	4,4
15	UC202G2L4	47,0	16,0	31,0	12,7	29,0	4,4
17	UC203G2L4	47,0	16,0	31,0	12,7	29,0	4,4
20	UC204G2L4	47,0	16,0	31,0	12,7	29,0	4,4
25	UC205G2L4	52,0	17,0	34,0	14,3	34,0	4,3
30	UC206G2L4	62,0	19,0	38,1	15,9	40,3	5,0
35	UC207G2L4	72,0	20,0	42,9	17,5	48,0	5,8
40	UC208G2L4	80,0	21,0	49,2	19,0	53,0	6,3
45	UC209G2L4	85,0	22,0	49,2	19,0	57,2	6,8
50	UC210G2L4	90,0	23,0	51,6	19,0	61,8	6,5

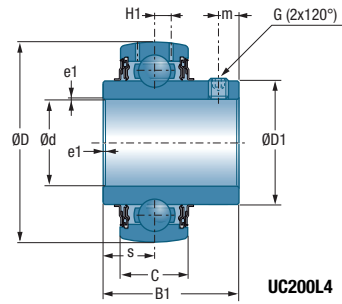
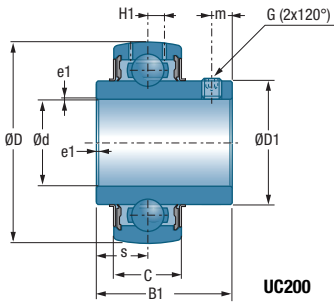

Main dimensions [mm]

Main dimensions [mm]				Dynamic load rating	Static load rating	Weight	Shaft diameter
m	G	a*	e1	C_r [kN]	C_{0r} [kN]	kg	d mm
4,7	M6x1	3,0	0,6	12,80	6,65	0,21	12
4,7	M6x1	3,0	0,6	12,80	6,65	0,20	15
4,7	M6x1	3,0	0,6	12,80	6,65	0,18	17
4,7	M6x1	3,0	0,6	12,80	6,65	0,17	20
5,5	M6x1	3,0	0,6	14,00	7,88	0,21	25
5,5	M6x1	3,0	0,6	19,50	11,20	0,32	30
6,5	M8x1	4,0	1,1	25,70	15,20	0,47	35
8,0	M8x1	4,0	1,1	29,60	18,20	0,64	40
8,0	M8x1	4,0	1,1	31,85	20,80	0,68	45
9,0	M10x1,25	5,0	1,1	35,10	23,20	0,80	50
9,0	M10x1,25	5,0	1,1	43,55	29,20	1,12	55
10,5	M10x1,25	5,0	1,1	52,50	32,80	1,53	60
12,0	M12x1,25	6,0	1,5	57,20	40,00	1,86	65
12,0	M12x1,25	6,0	2,0	62,00	45,00	2,05	70
12,0	M12x1,25	6,0	2,0	66,00	49,50	2,21	75
14,0	M12x1,25	6,0	2,0	72,50	54,20	2,79	80
14,0	M12x1,25	6,0	2,0	83,20	63,80	3,38	85
14,0	M12x1,25	6,0	2,0	96,00	71,50	4,45	90
5,0	M6x1	3,0	0,6	12,80	6,65	0,29	12
5,0	M6x1	3,0	0,6	12,80	6,65	0,27	15
5,0	M6x1	3,0	0,6	12,80	6,65	0,25	17
5,0	M6x1	3,0	0,6	12,80	6,65	0,22	20
5,0	M6x1	3,0	0,6	14,00	7,88	0,21	25
6,0	M6x1	3,0	0,6	19,50	11,20	0,32	30
6,5	M8x1	4,0	1,1	25,70	15,20	0,47	35
6,5	M8x1	4,0	1,1	29,60	18,20	0,64	40
6,5	M8x1	4,0	1,1	31,85	20,80	0,88	45
6,5	M8x1	4,0	1,1	35,10	23,20	0,15	50

* Width across flats (hexagon socket)



→ Bearing insert

with set screws
US200

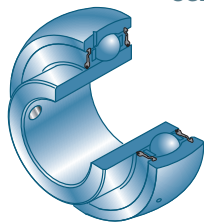

with tight fit
non-relubricatable
CS200

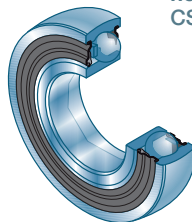

d mm	Bearing insert	Main dimensions [mm]					
		D	C	B1	s _{max}	D1	H1
12	US201G2	40,0	12,0	22,0	6,0	24,6	3,6
15	US202G2	40,0	12,0	22,0	6,0	24,6	3,6
17	US203G2	40,0	12,0	22,0	6,0	24,6	3,6
20	US204G2	47,0	14,0	25,0	7,0	29,0	4,0
25	US205G2	52,0	15,0	27,0	7,5	34,0	4,3
30	US206G2	62,0	16,0	30,0	8,0	40,3	5,0
35	US207G2	72,0	17,0	32,0	8,5	48,0	5,7
40	US208G2	80,0	18,0	34,0	9,0	53,0	6,2
45	US209G2	85,0	19,0	41,2	10,2	57,2	6,5
50	US210G2	90,0	20,0	43,5	10,9	61,8	6,5
55	US211G2	100,0	23,0	45,3	11,8	69,0	7,2
60	US212G2	110,0	24,0	53,7	14,9	74,9	8,0

12	CS201	40	12			24,6	
15	CS202	40	12			24,6	
17	CS203	40	12			24,6	
20	CS204	47	14			29,0	
25	CS205	52	15			34,0	
30	CS206	62	16			40,3	
35	CS207	72	17			48,0	
40	CS208	80	18			53,0	
45	CS209	85	19			57,2	
50	CS210	90	20			61,8	

Ød* : Inner ring bore according ISO 492 rather DIN 620-2

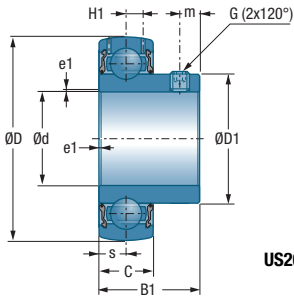

US200

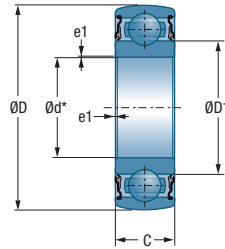

CS200

Main dimensions [mm]

Main dimensions [mm]				Dynamic load rating	Static load rating	Weight	Shaft diameter
m	G	a*	e1	C_r [kN]	C_{0r} [kN]	kg	d mm
4,0	M5x0,8	2,5	0,6	9,55	4,78	0,09	12
4,0	M5x0,8	2,5	0,6	9,55	4,78	0,08	15
4,0	M5x0,8	2,5	0,6	9,55	4,78	0,10	17
5,0	M6x1	3,0	0,6	12,80	6,65	0,13	20
5,5	M6x1	3,0	0,6	14,00	7,88	0,17	25
6,0	M6x1	3,0	0,6	19,50	11,20	0,27	30
6,5	M6x1	3,0	0,6	25,70	15,20	0,42	35
7,0	M8x1	4,0	1,1	29,60	18,20	0,60	40
8,2	M8x1	4,0	1,1	31,85	20,80	0,65	45
9,2	M8x1	4,0	1,1	35,10	23,20	0,76	50
9,8	M10x1,25	5,0	1,1	43,55	29,20	1,07	55
9,8	M10x1,25	5,0	1,1	52,50	32,80	1,30	60

* Width across flats (hexagon socket)

	0,6	9,58	4,78	0,065	12
	0,6	9,58	4,78	0,060	15
	0,6	9,58	4,78	0,050	17
	0,6	12,80	6,65	0,095	20
	0,6	14,00	7,88	0,110	25
	0,6	19,50	11,50	0,180	30
	0,6	25,50	15,20	0,250	35
	1,1	29,60	18,20	0,320	40
	1,1	31,50	20,80	0,370	45
	1,1	35,1	23,20	0,410	50



→ Bearing insert

with eccentric locking collar

ES200

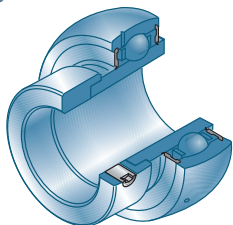

d mm	Bearing insert	Main dimensions [mm]						
		D	C	B1	J2	B	s _{max}	D2
12	ES201G2	40	12	19,1	13,5	28,6	6,5	27,2
15	ES202G2	40	12	19,1	13,5	28,6	6,5	27,2
17	ES203G2	40	12	19,1	13,5	28,6	6,5	27,2
20	ES204G2	47	14	21,4	13,5	30,9	7,5	32,4
25	ES205G2	52	15	21,4	13,5	30,9	7,5	37,4
30	ES206G2	62	16	23,8	15,9	35,7	9,0	44,1
35	ES207G2	72	17	25,4	17,5	38,9	9,5	51,1
40	ES208G2	80	18	30,2	18,3	43,7	11,0	58,0
45	ES209G2	85	19	30,2	18,3	43,7	11,0	63,5
50	ES210G2	90	20	30,2	18,3	43,7	11,0	67,2
55	ES211G2	100	24	32,5	20,7	48,4	12,0	74,5
60	ES212G2	110	24	33,4	22,3	49,3	12,0	82,0

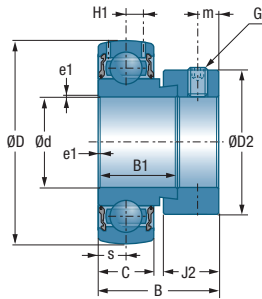

Main dimensions [mm]

Main dimensions [mm]					Dynamic load rating	Static load rating	Weight	Shaft diameter
H1	m	G	a*	e1	C_r [kN]	C_{0r} [kN]	kg	d mm
3,6	5,0	M6x1	3	0,6	9,55	4,78	0,14	12
3,6	5,0	M6x1	3	0,6	9,55	4,78	0,13	15
3,6	5,0	M6x1	3	0,6	9,55	4,78	0,13	17
4,0	5,0	M6x1	3	0,6	12,80	6,65	0,15	20
4,3	5,0	M6x1	3	0,6	14,00	7,88	0,19	25
5,0	6,0	M8x1	3	0,6	19,50	11,20	0,33	30
5,7	6,5	M8x1	4	1,1	25,70	15,20	0,50	35
6,2	6,5	M8x1	4	1,1	29,60	18,20	0,65	40
6,5	6,5	M8x1	4	1,1	31,85	20,80	0,69	45
6,5	6,5	M8x1	4	1,1	35,10	23,20	0,80	50
7,2	8,0	M10x1,25	5	1,1	43,55	29,20	0,87	55
8,0	8,0	M10x1,25	5	1,1	52,50	32,80	1,20	60

* Width across flats (hexagon socket)



→ Bearing insert

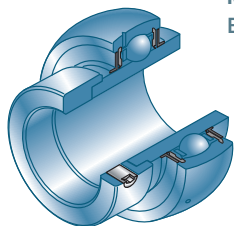

with eccentric locking collar
EX200

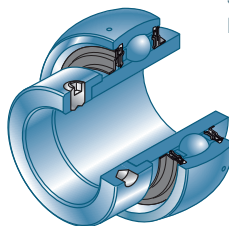

and extended sealing system
EX200L4

<div style="display: flex; flex-direction: column; align-items: center;"> Shaft diameter Bearing insert </div>		Main dimensions [mm]						
		D	C	B1	J2	B	s _{max}	D2
12	EX201G2	47	16	34,0	13,5	43,5	17,0	32,4
15	EX202G2	47	16	34,0	13,5	43,5	17,0	32,4
17	EX203G2	47	16	34,0	13,5	43,5	17,0	32,4
20	EX204G2	47	16	34,0	13,5	43,5	17,0	32,4
25	EX205G2	52	17	34,8	13,5	44,3	17,4	37,4
30	EX206G2	62	19	36,4	15,9	48,3	18,2	44,1
35	EX207G2	72	20	37,6	17,5	51,1	18,8	51,1
40	EX208G2	80	21	42,8	18,3	56,3	21,4	58,0
45	EX209G2	85	22	42,8	18,3	56,3	21,4	63,5
50	EX210G2	90	23	49,2	18,3	62,7	24,6	67,2
55	EX211G2	100	25	55,4	20,7	71,3	27,7	74,5
60	EX212G2	110	27	61,8	22,3	77,7	30,9	82,0
65	EX213G2	120	28	68,2	23,5	85,7	34,1	86,0
70	EX214G2	125	30	68,2	23,5	85,7	34,1	96,8
75	EX215G2	130	30	74,6	23,9	92,1	37,3	102,0
80	EX216G2	140	33	74,6	27,0	95,2	37,3	110,0
85	EX217G2	150	35	53,2	27,0	73,2	23,4	119,0
90	EX218G2	160	37	55,0	24,0	72,5	24,5	120,0

12	EX201G2L4	47	16	34,0	13,5	43,5	17,0	32,4
15	EX202G2L4	47	16	34,0	13,5	43,5	17,0	32,4
17	EX203G2L4	47	16	34,0	13,5	43,5	17,0	32,4
20	EX204G2L4	47	16	34,0	13,5	43,5	17,0	32,4
25	EX205G2L4	52	17	34,8	13,5	44,3	17,4	37,4
30	EX206G2L4	62	19	36,4	15,9	48,3	18,2	44,1
35	EX207G2L4	72	20	37,6	17,5	51,1	18,8	51,1
40	EX208G2L4	80	21	42,8	18,3	56,3	21,4	58,0
45	EX209G2L4	85	22	42,8	18,3	56,3	21,4	63,5
50	EX210G2L4	90	23	49,2	18,3	62,7	24,6	67,2

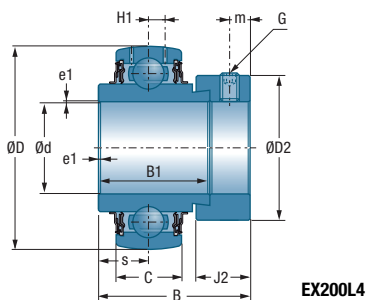
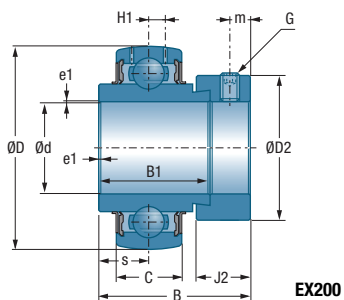

Main dimensions [mm]

Main dimensions [mm]					Dynamic load rating	Static load rating	Weight	Shaft diameter
H1	m	G	a*	e1	C_r [kN]	C_{0r} [kN]	kg	d mm
4,4	5,0	M6x1	3	0,6	12,80	6,65	0,29	12
4,4	5,0	M6x1	3	0,6	12,80	6,65	0,27	15
4,4	5,0	M6x1	3	0,6	12,80	6,65	0,25	17
4,4	5,0	M6x1	3	0,6	12,80	6,65	0,22	20
4,3	5,0	M6x1	3	0,6	14,00	7,88	0,25	25
5,0	6,0	M6x1	3	0,6	19,50	11,20	0,41	30
5,8	6,5	M8x1	4	1,1	25,70	15,20	0,60	35
6,3	6,5	M8x1	4	1,1	29,60	18,20	0,78	40
6,8	6,5	M8x1	4	1,1	31,85	20,80	0,87	45
6,5	6,5	M8x1	4	1,1	35,10	23,20	1,01	50
7,2	8,0	M10x1,25	5	1,5	43,55	29,20	1,39	55
8,2	8,0	M10x1,25	5	1,5	52,50	32,80	1,87	60
8,0	8,5	M10x1,25	5	1,5	57,20	40,00	2,41	65
9,0	8,5	M10x1,25	5	2,0	62,00	45,00	2,57	70
9,0	8,5	M10x1,25	5	2,0	66,00	49,50	2,84	75
10,3	10,3	M12x1,25	6	2,0	72,50	54,20	3,12	80
11,0	10,0	M12x1,25	6	2,0	83,20	63,80	3,72	85
12,0	9,5	M12x1,25	6	2,0	96,00	71,50	4,90	90
4,4	5,0	M6x1	3	0,6	12,80	6,65	0,31	12
4,4	5,0	M6x1	3	0,6	12,80	6,65	0,29	15
4,4	5,0	M6x1	3	0,6	12,80	6,65	0,27	17
4,4	5,0	M6x1	3	0,6	12,80	6,65	0,24	20
4,3	5,0	M6x1	3	0,6	14,00	7,88	0,27	25
5,0	6,0	M6x1	3	0,6	19,50	11,20	0,42	30
5,8	6,5	M8x1	4	1,1	25,70	15,20	0,63	35
6,3	6,5	M8x1	4	1,1	29,60	18,20	0,80	40
6,8	6,5	M8x1	4	1,1	31,85	20,80	0,90	45
6,5	6,5	M8x1	4	1,1	35,10	23,20	1,10	50

* Width across flats (hexagon socket)



→ Bearing insert

with adapter sleeve

UK200H

LK200H (light-weight design)

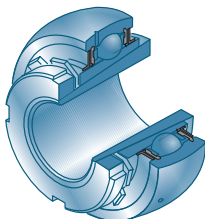

d mm	Shaft diameter	Bearing insert + adapter sleeve	Main dimensions [mm]							
			D	C	B1	c	B	d1	D1	D2
20	UK205G2H		52	17	21	8,0	35	25	34,0	38
25	UK206G2H		62	19	25	8,0	38	30	40,3	45
30	UK207G2H		72	20	27	9,0	43	35	48,0	52
35	UK208G2H		80	21	29	10,0	46	40	53,0	58
40	UK209G2H		85	22	30	11,0	50	45	57,2	65
45	UK210G2H		90	23	31	12,0	55	50	61,8	70
50	UK211G2H		100	25	33	12,5	59	55	69,0	75
55	UK212G2H		110	27	36	13,0	62	60	74,9	80
60	UK213G2H		120	28	36	14,0	65	65	82,0	85
65	UK215G2H		130	30	41	15,0	73	75	91,5	98
70	UK216G2H		140	33	44	17,0	78	80	98,0	105
75	UK217G2H		150	35	44	18,0	82	85	105,1	110
80	UK218G2H		160	37	48	18,0	86	90	111,0	120

20	LK204G2H		47	14	15	9,0	28		30,9	32
25	LK205G2H		52	15	15	9,2	28		35,7	38
30	LK206G2H		62	18	18	10,7	32		43,0	45
35	LK207G2H		72	19	19	11,2	34		48,6	52
40	LK208G2H		80	21	22	12,2	38		55,0	58
45	LK209G2H		85	22	22	12,2	38		59,2	64
50	LK210G2H		90	22	22	14,2	40		64,2	70

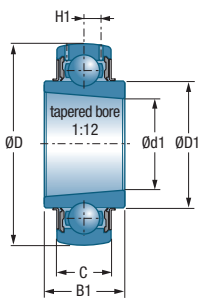

UK200 / LK200

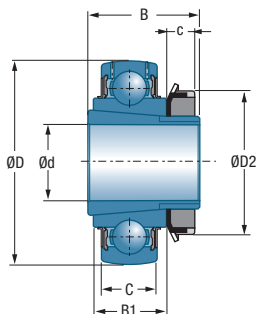

UK200H / LK200H

H1	Bearing insert	Adapter sleeve	Dynamic load rating C_r [kN]	Static load rating C_{Or} [kN]	Weight total of Bearing insert + adapter sleeve kg	Bearing insert weight kg	Shaft diameter d mm
4,3	UK205G2	H2305	14,00	7,88	0,24	0,15	20
5,0	UK206G2	H2306	19,50	11,20	0,38	0,25	25
5,8	UK207G2	H2307	25,70	15,20	0,54	0,37	30
6,3	UK208G2	H2308	29,60	18,20	0,70	0,48	35
6,8	UK209G2	H2309	31,85	20,80	0,81	0,53	40
6,5	UK210G2	H2310	35,10	23,20	0,95	0,59	45
7,2	UK211G2	H2311	43,55	29,20	1,19	0,77	50
8,2	UK212G2	H2312	52,50	32,80	1,51	1,03	55
8,0	UK213G2	H2313	57,20	40,00	1,92	1,36	60
9,0	UK215G2	H2315	66,00	49,50	2,72	1,67	65
10,3	UK216G2	H2316	72,50	54,20	3,24	1,96	70
11,0	UK217G2	H2317	83,20	63,80	3,87	2,42	75
12,0	UK218G2	H2318	96,00	71,50	4,69	3,00	80
4,0	LK204	HLK2304	12,70	6,60	0,14		20
4,3	LK205	HLK2305	13,60	7,80	0,17		25
5,0	LK206	HLK2306	18,90	11,30	0,28		30
5,7	LK207	HLK2307	24,90	15,30	0,40		35
6,2	LK208	HLK2308	29,50	19,80	0,54		40
6,5	LK209	HLK2309	31,85	19,80	0,57		45
6,5	LK210	HLK2310	33,00	19,90	0,68		50

For the size of the appropriate hook spanner refer on page 22 in our ball bearing catalogue (TC09).

→ Bearing insert

with rubber damping ring

ESR200, CESR200

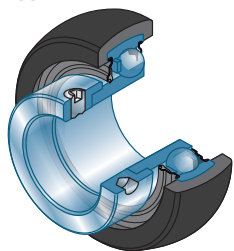

Form: spherical

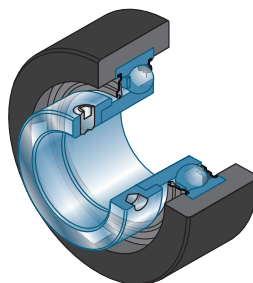

Form: cylindrical

d mm	Unit	Bearing insert	rubber damping ring	Form	Main dimensions [mm]			
					D	D3	C _D	C
12	ESR201B	ES201SRS	SRBB203	spherical	40	47,3	17,6	12,0
15	ESR202B	ES202SRS	SRBB203	spherical	40	47,3	17,6	12,0
20	ESR204B	ES204SRS	SRBB204	spherical	47	52,3	17,6	14,0
25	ESR205B	ES205SRS	SRBB205	spherical	52	62,2	20,8	15,0
30	ESR206B	ES206SRS	SRBB206	spherical	62	72,2	23,0	18,0
35	ESR207B	ES207SRS	SRBB207	spherical	72	80,2	24,0	19,0
40	ESR208B	ES208SRS	SRBB208	spherical	80	85,0	27,0	21,0
50	ESR210B	ES210SRS	SRBB210	spherical	90	100,2	30,0	22,0

15	CESR202A	CES202SRS	SRCA203	cylindrical	40	65,1	25,4	12,0
17	CESR203A	CES203SRS	SRCA203	cylindrical	40	65,1	25,4	12,0
20	CESR204A	CES204SRS	SRCA204	cylindrical	47	65,1	25,4	14,0
25	CESR205A	CES205SRS	SRCA205	cylindrical	52	65,1	25,4	15,0

- Rubber damping rings are intended to reduce noise and vibration
- Hardness of rubber: $70 \pm 5^\circ$ SHORE A / Material: NBR
- Filled with long life grease / non-relubricatable

- Reduced friction torque through optimised sealing lip
- Noise inspected
- Operating temperatures: -20°C up to $+85^\circ\text{C}$
- Inner- and eccentric ring zinc-plated

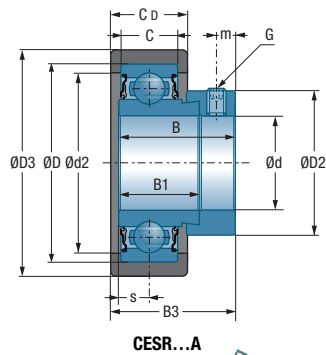
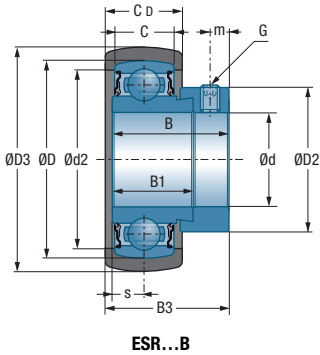

Main dimensions [mm]

Dynamic load rating
 Static load rating
 Weight unit
 Shaft diameter

B	B1	B3	D2	d2	s	m	G	C_r [kN]	C_{0r} [kN]	[kg]	d mm
28,6	19,0	30,9	27,2	33,5	6,5	5,0	M6x1	9,55	4,78	0,16	12
28,6	19,0	30,9	27,2	33,5	6,5	5,0	M6x1	9,55	4,78	0,15	15
31,0	21,4	32,3	32,4	39,0	7,5	5,0	M6x1	12,80	6,65	0,18	20
31,0	21,4	33,9	37,4	44,5	7,5	5,0	M6x1	14,00	7,88	0,22	25
35,7	23,8	38,2	44,1	54,0	9,0	6,0	M8x1	19,50	11,20	0,37	30
38,9	25,4	41,4	51,1	62,0	9,5	6,5	M8x1	25,70	15,20	0,54	35
43,7	30,2	46,2	58,0	70,0	11,0	6,5	M8x1	29,60	18,20	0,68	40
43,7	30,2	47,7	67,2	80,0	11,0	6,5	M8x1	35,10	23,20	0,88	50

28,6	19,0	34,8	27,2	35,0	6,5	5,0	M6x1	9,55	4,78	0,21	15
28,6	19,0	34,8	27,2	35,0	6,5	5,0	M6x1	9,55	4,78	0,20	17
31,0	21,4	36,2	32,4	40,0	7,5	5,0	M6x1	12,80	6,65	0,22	20
31,0	21,4	36,2	37,4	46,0	7,5	5,0	M6x1	14,00	7,88	0,26	25



→ Bearing insert

with set screws

UC300

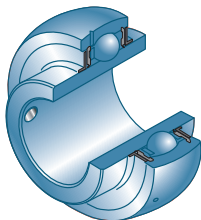

d mm	Bearing insert	Main dimensions [mm]					
		D	C	B1	s _{max}	D1	H1
25	UC305G2	62	21	38	15	35,4	6,2
30	UC306G2	72	24	43	17	44,6	6,5
35	UC307G2	80	25	48	19	48,9	7,2
40	UC308G2	90	28	52	19	56,5	8,5
45	UC309G2	100	30	57	22	61,8	9,0
50	UC310G2	110	32	61	22	68,7	9,9
55	UC311G2	120	34	66	25	74,9	10,6
60	UC312G2	130	36	71	26	81,0	11,3
65	UC313G2	140	38	75	30	87,5	12,1
70	UC314G2	150	40	78	33	94,0	12,8
75	UC315G2	160	42	82	32	100,5	13,5
80	UC316G2	170	44	86	34	107,9	14,5
85	UC317G2	180	46	96	40	114,0	15,5
90	UC318G2	190	48	96	40	120,0	16,5
95	UC319G2	200	50	103	41	126,5	16,7
100	UC320G2	215	54	108	42	134,5	19,0
105	UC321G2	225	57	112	44	140,5	20,0
110	UC322G2	240	60	117	46	149,0	21,0
120	UC324G2	260	64	126	51	163,0	22,0
130	UC326G2	280	68	135	54	177,0	23,0
140	UC328G2	300	73	145	59	190,0	25,0

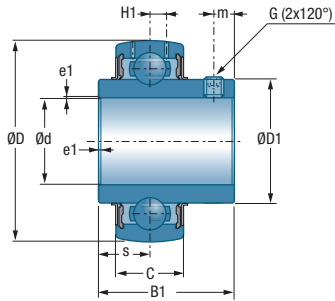

Main dimensions [mm]				Dynamic load rating	Static load rating	Weight	Shaft diameter
m	G	a*	e1	C _r [kN]	C _{0r} [kN]	kg	d mm
6,0	M6x1	3	1,5	22,36	11,50	0,35	25
6,0	M6x1	3	1,5	27,00	15,20	0,56	30
8,0	M8x1	4	2,0	33,50	19,20	0,71	35
10,0	M10x1,25	5	2,0	40,56	24,00	0,96	40
10,0	M10x1,25	5	2,0	53,00	31,80	1,28	45
12,0	M12x1,25	6	2,0	62,00	37,80	1,65	50
12,0	M12x1,25	6	2,0	71,50	44,80	1,90	55
12,0	M12x1,25	6	2,0	81,60	51,80	2,60	60
12,0	M12x1,25	6	2,0	93,86	60,50	3,25	65
12,0	M12x1,25	6	2,5	104,26	68,00	3,95	70
14,0	M14x1,5	6	2,5	113,36	76,80	4,33	75
14,0	M14x1,5	6	3,0	122,85	86,50	5,57	80
16,0	M16x1,5	8	3,0	132,60	96,50	6,84	85
16,0	M16x1,5	8	3,5	143,00	108,00	7,87	90
18,0	M16x1,5	8	3,0	156,00	122,00	8,91	95
18,0	M18x1,5	9	3,5	171,60	140,00	11,20	100
18,0	M18x1,5	9	3,0	182,00	155,00	12,20	105
18,0	M18x1,5	9	3,0	205,00	178,00	14,30	110
18,0	M18x1,5	9	3,0	228,00	208,00	18,50	120
20,0	M20x1,5	10	4,0	252,00	242,00	23,00	130
20,0	M20x1,5	10	4,0	275,00	272,00	28,50	140

* Width across flats (hexagon socket)



→ Bearing insert

with eccentric locking collar

EX300

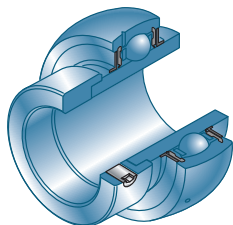

Shaft diameter		Bearing insert		Main dimensions [mm]					
d mm		D	C	B1	J2	B	s _{max}	D2	
25	EX305G2	62	21	34,9	15,9	46,8	16,7	42,8	
30	EX306G2	72	24	36,5	17,5	50,0	17,5	50,0	
35	EX307G2	80	25	38,1	17,5	51,6	18,3	55,0	
40	EX308G2	90	28	41,3	20,6	57,1	19,8	63,5	
45	EX309G2	100	30	42,9	20,6	58,7	19,8	70,0	
50	EX310G2	110	32	49,2	22,2	66,6	24,6	76,2	
55	EX311G2	120	34	55,6	22,2	73,0	27,8	83,0	
60	EX312G2	130	36	61,9	23,9	79,4	31,0	89,0	
65	EX313G2	140	38	65,1	27,0	85,7	32,5	97,0	
70	EX314G2	150	40	68,3	30,2	92,1	34,2	102,0	
75	EX315G2	160	42	74,6	31,8	100,0	37,3	113,0	
80	EX316G2	170	44	81,0	31,8	106,4	40,5	119,0	
85	EX317G2	180	46	84,1	31,8	109,5	42,0	127,0	
90	EX318G2	190	48	87,3	36,5	115,9	43,6	133,0	
95	EX319G2	200	50	93,7	36,5	122,3	46,8	140,0	
100	EX320G2	215	54	100,0	36,5	128,6	50,0	146,0	

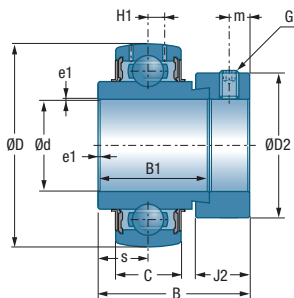

Main dimensions [mm]

Main dimensions [mm]					Dynamic load rating	Static load rating	Weight	Shaft diameter
H1	m	G	a*	e1	C_r [kN]	C_{0r} [kN]	kg	d mm
6,2	6,0	M8x1	4	1,5	22,36	11,50	0,43	25
6,5	6,7	M8x1	4	1,5	27,00	15,20	0,68	30
7,2	6,7	M8x1	4	2,0	33,50	19,20	0,80	35
8,5	8,0	M10x1,25	5	2,0	40,56	24,00	1,08	40
9,0	8,0	M10x1,25	5	2,0	53,00	31,80	1,45	45
9,9	8,7	M10x1,25	5	2,0	62,00	37,80	1,86	50
10,6	9,0	M10x1,25	5	2,0	71,50	44,80	2,30	55
11,3	9,0	M10x1,25	5	2,0	81,60	51,80	2,89	60
12,1	11,5	M12x1,25	6	2,0	93,86	60,50	3,66	65
12,8	12,0	M12x1,25	6	2,5	104,26	68,00	4,50	70
13,5	13,0	M16x1,5	8	2,5	113,36	76,80	5,34	75
14,5	13,0	M16x1,5	8	3,0	122,85	86,50	6,70	80
15,5	13,0	M16x1,5	8	3,0	132,60	96,50	7,96	85
16,5	14,5	M20x1,5	8	3,0	143,00	108,00	9,10	90
16,7	14,5	M20x1,5	8	3,0	156,00	122,00	10,40	95
19,0	14,5	M20x1,5	9	3,5	171,60	140,00	13,00	100

* Width across flats (hexagon socket)



→ Bearing insert

with adapter sleeve

UK300H

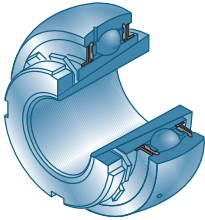

d mm	Shaft diameter	Bearing insert + adapter sleeve	Main dimensions [mm]							
			D	C	B1	c	B	d1	D1	D2
20	UK305G2H		62	21	27	8,0	35	25	35,4	38
25	UK306G2H		72	24	30	8,0	38	30	44,6	45
30	UK307G2H		80	25	33	9,0	43	35	48,9	52
35	UK308G2H		90	28	35	10,0	46	40	56,5	58
40	UK309G2H		100	30	38	11,0	50	45	61,8	65
45	UK310G2H		110	32	40	12,0	55	50	68,7	70
50	UK311G2H		120	34	43	12,5	59	55	74,9	75
55	UK312G2H		130	36	47	13,0	62	60	81,0	80
60	UK313G2H		140	38	49	14,0	65	65	87,5	85
65	UK315G2H		160	42	55	15,0	73	75	100,5	98
70	UK316G2H		170	44	55	17,0	78	80	107,9	105
75	UK317G2H		180	46	60	18,0	82	85	114,0	110
80	UK318G2H		190	48	60	18,0	86	90	120,0	120
85	UK319G2H		200	50	66	19,0	90	95	126,5	125
90	UK320G2H		215	54	68	20,0	97	100	134,5	130
100	UK322G2H		240	60	80	21,0	105	110	147,7	145
110	UK324G2H		260	64	86	22,0	112	120	162,1	155
115	UK326G2H		280	68	92	23,0	121	130	176,1	165
125	UK328G2H		300	72	98	24,0	131	140	189,0	180

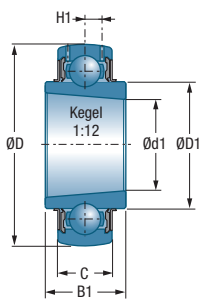

UK300

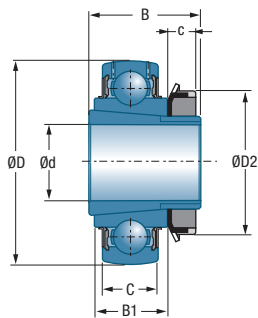

UK300H

	Bearing insert	Adapter sleeve	Dynamic load rating	Static load rating	Weight total Bearing insert + adapter sleeve	Weight bearing insert	Shaft diameter
H1			C_r [kN]	C_{0r} [kN]	kg	kg	d mm
6,2	UK305G2	H2305	22,36	11,50	0,49	0,40	20
6,5	UK306G2	H2306	27,00	15,20	0,59	0,46	25
7,2	UK307G2	H2307	33,50	19,20	0,92	0,75	30
8,5	UK308G2	H2308	40,56	24,00	1,03	0,81	35
9,0	UK309G2	H2309	53,00	31,80	1,47	1,19	40
9,9	UK310G2	H2310	62,00	37,80	1,74	1,38	45
10,6	UK311G2	H2311	71,50	44,80	2,20	1,78	50
11,3	UK312G2	H2312	81,60	51,80	2,54	2,06	55
12,1	UK313G2	H2313	93,86	60,50	3,27	2,71	60
13,5	UK315G2	H2315	113,36	76,80	5,03	3,98	65
14,5	UK316G2	H2316	122,85	86,50	5,83	4,55	70
15,5	UK317G2	H2317	132,60	96,50	6,89	5,44	75
16,5	UK318G2	H2318	143,00	108,00	7,94	6,25	80
16,7	UK319G2	H2319	156,00	122,00	9,23	7,31	85
19,0	UK320G2	H2320	171,60	140,00	10,97	8,82	90
21,0	UK322G2	H2322	205,00	178,00	17,64	14,90	100
22,0	UK324G2	H2324	228,00	208,00	21,19	18,00	110
23,0	UK326G2	H2326	252,00	242,00	27,90	23,30	115
25,0	UK328G2	H2328	275,00	272,00	34,45	28,90	125

For the size of the appropriate hook spanner refer on page 22 in our ball bearing catalogue (TC09).



→ Bearing insert

with cylindrical outer ring and set screws

CUC200

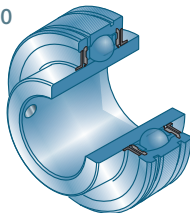

d mm	Bearing insert	Main dimensions [mm]							
		D	C	B1	s _{max}	D1	H1	m	N
20	CUC204	47	17	31,0	12,7	29,0	4,0	4,5	1,35
25	CUC205	52	17	34,0	14,3	34,0	4,1	5,0	1,35
30	CUC206	62	19	38,1	15,9	40,3	4,2	5,5	1,90
35	CUC207	72	20	42,9	17,5	46,9	5,0	6,5	1,90
40	CUC208	80	21	49,2	19,0	53,0	5,0	8,0	1,90
45	CUC209	85	22	49,2	19,0	57,2	5,1	8,0	1,90
50	CUC210	90	23	51,6	19,0	61,8	5,6	9,0	2,70

CUS200

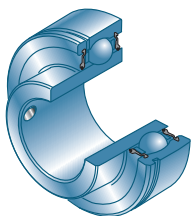

d mm	Bearing insert	Main dimensions [mm]						
		D	C	B1	s _{max}	D1	m	N
20	CUS204	47	14	25,0	7,0	28,3	5	1,35
25	CUS205	52	15	27,0	7,5	34,0	5	1,35
30	CUS206	62	16	30,0	8,0	40,0	5,5	1,90
35	CUS207	72	17	32,0	8,5	46,9	6	1,90
40	CUS208	80	18	34,0	9,0	52,4	8	1,90
45	CUS209	85	19	41,2	9,5	57,6	8	1,90
50	CUS210	90	20	43,5	10,0	63,2	9	2,70

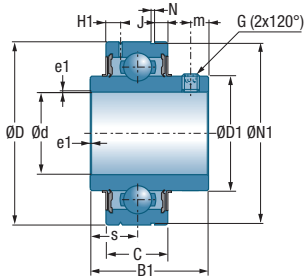

Main dimensions [mm]

Main dimensions [mm]					Dynamic load rating	Static load rating	Weight	Shaft diameter
J	N1	G	a*	e1	C_r [kN]	C_{0r} [kN]	kg	d mm
3,10	44,60	M6 x 1	3	0,6	12,80	6,65	0,20	20
3,20	49,73	M6 x 1	3	0,6	14,00	7,88	0,21	25
3,20	59,61	M6 x 1	3	0,6	19,50	11,20	0,35	30
3,30	68,81	M8 x 1	4	1,1	25,70	15,20	0,47	35
3,40	76,81	M8 x 1	4	1,1	29,60	18,20	0,64	40
3,50	81,81	M8 x 1	4	1,1	31,85	20,80	0,68	45
3,70	86,79	M10x1,25	5	1,1	35,10	23,20	0,80	50

* Width across flats (hexagon socket)

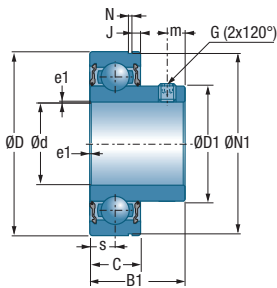

Main dimensions [mm]

Main dimensions [mm]					Dynamic load rating	Static load rating	Weight	Shaft diameter
J	N1	G	a*	e1	C_r [kN]	C_{0r} [kN]	kg	d mm
2,38	44,60	M6 x 1	3	1,0	12,80	6,65	0,13	20
2,38	49,73	M6 x 1	3	1,0	14,00	7,88	0,17	25
3,18	59,61	M6 x 1	3	1,0	19,50	11,20	0,27	30
3,18	68,81	M6 x 1	3	1,0	25,70	15,20	0,42	35
3,18	76,81	M8 x 1	4	1,0	29,60	18,20	0,48	40
3,18	81,81	M8 x 1	4	1,5	31,85	20,80	0,57	45
3,70	86,79	M8 x 1	4	1,5	35,10	23,20	0,66	50

* Width across flats (hexagon socket)

→ Bearing insert

with cylindrical outer ring and eccentric locking collar

CES200

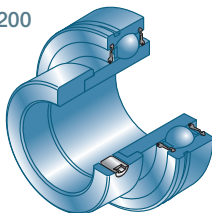

Shaft diameter	Bearing insert	Main dimensions [mm]								
		d mm	D	C	B1	J2	B	s _{max}	D2	m
20	CES204	47	14	21,5	13,5	31,0	7,0	33,3	5,0	1,35
25	CES205	52	15	21,5	13,5	31,0	7,5	38,1	5,0	1,35
30	CES206	62	16	23,8	15,9	35,7	8,0	44,5	6,0	1,90
35	CES207	72	17	25,4	17,5	38,9	8,5	55,6	6,5	1,90
40	CES208	80	18	30,2	18,3	43,7	9,0	60,3	6,5	1,90
45	CES209	85	19	30,2	18,3	43,7	9,5	63,5	6,5	1,90
50	CES210	90	20	30,2	18,3	43,7	10,0	69,9	6,5	2,70

CEX200

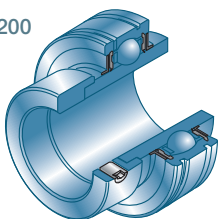

Shaft diameter	Bearing insert	Main dimensions [mm]								
		d mm	D	C	B1	J2	B	s _{max}	D2	H1
20	CEX204	47	17	34,2	13,5	43,7	17,1	33,3	4,0	5,0
25	CEX205	52	17	34,9	13,5	44,4	17,5	38,1	4,1	5,0
30	CEX206	62	19	36,5	15,9	48,4	18,3	44,5	4,2	6,0
35	CEX207	72	20	37,6	17,5	51,1	18,8	55,5	5,0	6,5
40	CEX208	80	21	42,8	18,3	56,3	21,4	60,3	5,0	6,5
45	CEX209	85	22	42,8	18,3	56,3	21,4	63,5	5,1	6,5
50	CEX210	90	24	49,2	18,3	62,7	24,6	69,5	5,6	6,5

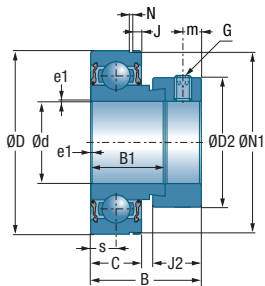

Main dimensions [mm]

Main dimensions [mm]					Dynamic load rating	Static load rating	Weight	Shaft diameter
J	N1	G	a*	e1	C_r [kN]	C_{0r} [kN]	kg	d mm
2,38	44,60	M6x1	3	1,0	12,80	6,65	0,15	20
2,38	49,73	M6x1	3	1,0	14,00	7,88	0,19	25
3,18	59,61	M6x1	3	1,0	19,50	11,20	0,33	30
3,18	68,81	M8x1	4	1,5	25,70	15,20	0,50	35
3,18	76,81	M8x1	4	1,5	29,60	18,20	0,65	40
3,18	81,81	M8x1	4	1,5	31,85	20,80	0,69	45
3,70	86,79	M8x1	4	1,5	35,10	23,20	0,80	50

* Width across flats (hexagon socket)

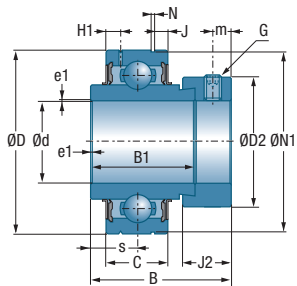

Main dimensions [mm]

Main dimensions [mm]						Dynamic load rating	Static load rating	Weight	Shaft diameter
N	J	N1	G	a*	e1	C_r [kN]	C_{0r} [kN]	kg	d mm
1,35	3,1	44,60	M6x1	3	1,0	12,80	6,65	0,22	20
1,35	3,2	49,73	M6x1	3	1,0	14,00	7,88	0,25	25
1,90	3,2	59,61	M6x1	3	1,0	19,50	11,20	0,41	30
1,90	3,3	68,81	M8x1	4	1,5	25,70	15,20	0,60	35
1,90	3,4	76,81	M8x1	4	1,5	29,60	18,20	0,78	40
1,90	3,5	81,81	M8x1	4	1,5	31,85	20,80	0,87	45
2,70	3,7	86,79	M8x1	4	1,5	35,10	23,20	1,01	50

* Width across flats (hexagon socket)

→ Bearing insert - inch

with set screws

UC200

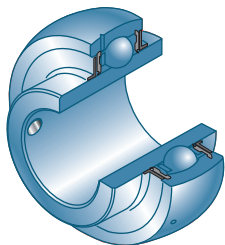

Shaft diameter		Bearing insert		Main dimensions [mm]			
d inch		D	C	B1	s _{max}	D1	H1
1/2	UC201-08G2	47	16	31,0	12,7	29,0	4,4
5/8	UC202-10G2	47	16	31,0	12,7	29,0	4,4
11/16	UC203-11G2	47	16	31,0	12,7	29,0	4,4
3/4	UC204-12G2	47	16	31,0	12,7	29,0	4,4
7/8	UC205-14G2	52	17	34,0	14,3	34,0	4,3
15/16	UC205-15G2	52	17	34,0	14,3	34,0	4,3
1	UC205-16G2	52	17	34,0	14,3	34,0	4,3
1 1/8	UC206-18G2	62	19	38,1	15,9	40,3	5,0
1 3/16	UC206-19G2	62	19	38,1	15,9	40,3	5,0
1 1/4	UC206-20G2	62	19	38,1	15,9	40,3	5,0
1 3/8	UC207-22G2	72	20	42,9	17,5	48,0	5,8
1 7/16	UC207-23G2	72	20	42,9	17,5	48,0	5,8
1 1/2	UC208-24G2	80	21	49,2	19,0	53,0	6,3
1 5/8	UC209-26G2	85	22	49,2	19,0	57,2	6,8
1 11/16	UC209-27G2	85	22	49,2	19,0	57,2	6,8
1 3/4	UC209-28G2	85	22	49,2	19,0	57,2	6,8
1 7/8	UC210-30G2	90	23	51,6	19,0	61,8	6,5
1 15/16	UC210-31G2	90	23	51,6	19,0	61,8	6,5
2	UC211-32G2	100	25	55,6	22,2	69,0	7,2
2 3/16	UC211-35G2	100	25	55,6	22,2	69,0	7,2
2 1/4	UC212-36G2	110	27	65,1	25,4	74,9	8,2
2 7/16	UC212-39G2	110	27	65,1	25,4	74,9	8,2
2 1/2	UC213-40G2	120	28	65,1	25,4	82,0	8,0
2 11/16	UC214-43G2	125	30	74,6	30,2	86,5	9,0
2 3/4	UC214-44G2	125	30	74,6	30,2	86,5	9,0
2 15/16	UC215-47G2	130	30	77,8	33,3	91,5	9,0
3	UC215-48G2	130	30	77,8	33,3	91,5	9,0
3 1/4	UC217-52G2	150	35	85,7	34,1	105,1	11,0
3 1/2	UC218-56G2	160	37	96,0	39,7	111,0	12,0

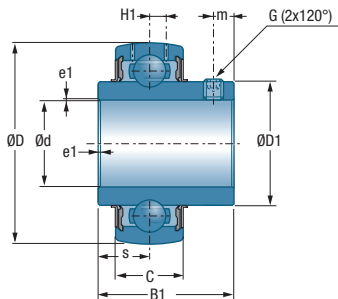

Main dimensions [mm]

Main dimensions [mm]				Dynamic load rating	Static load rating	Weight	Shaft diameter
m	G	a* inch	e1	C _r [kN]	C _{0r} [kN]	kg	d inch
4,7	1/4-28UNF	1/8	0,6	12,80	6,65	0,21	1/2
4,7	1/4-28UNF	1/8	0,6	12,80	6,65	0,20	5/8
4,7	1/4-28UNF	1/8	0,6	12,80	6,65	0,18	11/16
4,7	1/4-28UNF	1/8	0,6	12,80	6,65	0,17	3/4
5,5	1/4-28UNF	1/8	0,6	14,00	7,88	0,21	7/8
5,5	1/4-28UNF	1/8	0,6	14,00	7,88	0,21	15/16
5,5	1/4-28UNF	1/8	0,6	14,00	7,88	0,20	1
5,5	1/4-28UNF	1/8	0,6	19,50	11,20	0,34	1 1/8
5,5	1/4-28UNF	1/8	0,6	19,50	11,20	0,31	1 3/16
5,5	1/4-28UNF	1/8	0,6	19,50	11,20	0,30	1 1/4
6,5	5/16-24UNF	5/32	1,1	25,70	15,20	0,48	1 3/8
6,5	5/16-24UNF	5/32	1,1	25,70	15,20	0,45	1 7/16
8,0	5/16-24UNF	5/32	1,1	29,60	18,20	0,68	1 1/2
8,0	5/16-24UNF	5/32	1,1	31,85	20,80	0,78	1 5/8
8,0	5/16-24UNF	5/32	1,1	31,85	20,80	0,74	1 11/16
8,0	5/16-24UNF	5/32	1,1	31,85	20,80	0,70	1 3/4
9,0	3/8-24UNF	3/16	1,1	35,10	23,20	0,87	1 7/8
9,0	3/8-24UNF	3/16	1,1	35,10	23,20	0,82	1 15/16
9,0	3/8-24UNF	3/16	1,1	43,55	29,20	1,27	2
9,0	3/8-24UNF	3/16	1,1	43,55	29,20	1,10	2 3/16
10,5	3/8-24UNF	3/16	1,1	52,50	32,80	1,67	2 1/4
10,5	3/8-24UNF	3/16	1,1	52,50	32,80	1,45	2 7/16
12,0	3/8-24UNF	3/16	1,5	57,20	40,00	1,94	2 1/2
12,0	3/8-24UNF	3/16	2,0	62,00	45,00	2,02	2 11/16
12,0	7/16-20UNF	7/32	2,0	62,00	45,00	2,06	2 3/4
12,0	7/16-20UNF	7/32	2,0	66,00	49,50	2,30	2 15/16
12,0	7/16-20UNF	7/32	2,0	66,00	49,50	2,13	3
14,0	7/16-20UNF	7/32	2,0	83,20	63,80	3,32	3 1/4
14,0	1/2-20UNF	1/4	2,0	96,00	71,50	4,56	3 1/2

* Width across flats (hexagon socket)



→ Bearing insert - inch

with set screws

US200

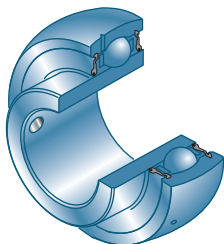

Shaft diameter		Bearing insert		Main dimensions [mm]			
d inch		D	C	B1	s _{max}	D1	H1
1/2	US201-08G2	40	12	22,0	6,0	24,6	3,6
5/8	US202-10G2	40	12	22,0	6,0	24,6	3,6
11/16	US203-11G2	40	12	22,0	6,0	24,6	3,6
3/4	US204-12G2	47	14	25,0	7,0	29,0	4,0
7/8	US205-14G2	52	15	27,0	7,5	34,0	4,3
15/16	US205-15G2	52	15	27,0	7,5	34,0	4,3
1	US205-16G2	52	15	27,0	7,5	34,0	4,3
1 1/8	US206-18G2	62	16	30,0	8,0	40,3	5,0
1 3/16	US206-19G2	62	16	30,0	8,0	40,3	5,0
1 1/4	US206-20G2	62	16	30,0	8,0	40,3	5,0
1 3/8	US207-22G2	72	17	32,0	8,5	48,0	5,7
1 7/16	US207-23G2	72	17	32,0	8,5	48,0	5,7
1 1/2	US208-24G2	80	18	34,0	9,0	53,0	6,2
1 5/8	US209-26G2	85	19	41,2	10,2	57,2	6,5
1 11/16	US209-27G2	85	19	41,2	10,2	57,2	6,5
1 3/4	US209-28G2	85	19	41,2	10,2	57,2	6,5
1 7/8	US210-30G2	90	20	43,5	10,9	61,8	6,5
1 15/16	US210-31G2	90	20	43,5	10,9	61,8	6,5
2	US211-32G2	100	23	45,3	11,8	69,0	7,2
2 3/16	US211-35G2	100	23	45,3	11,8	69,0	7,2
2 1/4	US212-36G2	110	24	53,7	14,9	74,9	8,0
2 7/16	US212-39G2	110	24	53,7	14,9	74,9	8,0

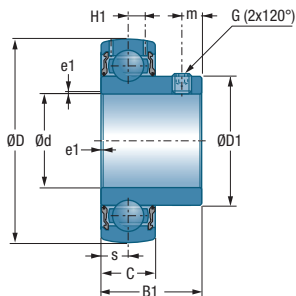

Main dimensions [mm]

Main dimensions [mm]				Dynamic load rating	Static load rating	Weight	Shaft diameter
m	G	a* inch	e1	C _r [kN]	C _{0r} [kN]	kg	d inch
4,0	10-32UNF	3/32	0,6	9,55	4,78	0,09	1/2
4,0	10-32UNF	3/32	0,6	9,55	4,78	0,08	5/8
4,0	10-32UNF	3/32	0,6	9,55	4,78	0,10	11/16
5,0	1/4-28UNF	1/8	0,6	12,80	6,65	0,13	3/4
5,5	1/4-28UNF	1/8	0,6	14,00	7,88	0,18	7/8
5,5	1/4-28UNF	1/8	0,6	14,00	7,88	0,18	15/16
5,5	1/4-28UNF	1/8	0,6	14,00	7,88	0,16	1
6,0	1/4-28UNF	1/8	0,6	19,50	11,20	0,28	1 1/8
6,0	1/4-28UNF	1/8	0,6	19,50	11,20	0,25	1 3/16
6,0	1/4-28UNF	1/8	0,6	19,50	11,20	0,24	1 1/4
6,5	5/16-24UNF	5/32	0,6	25,70	15,20	0,38	1 3/8
6,5	5/16-24UNF	5/32	0,6	25,70	15,20	0,37	1 7/16
7,0	5/16-24UNF	5/32	1,1	29,60	18,20	0,60	1 1/2
8,2	5/16-24UNF	5/32	1,1	31,85	20,80	0,75	1 5/8
8,2	5/16-24UNF	5/32	1,1	31,85	20,80	0,72	1 11/16
8,2	5/16-24UNF	5/32	1,1	31,85	20,80	0,67	1 3/4
9,2	5/16-24UNF	5/32	1,1	35,10	23,20	0,80	1 7/8
9,2	5/16-24UNF	5/32	1,1	35,10	23,20	0,78	1 15/16
9,8	5/16-24UNF	5/32	1,1	43,55	29,20	1,10	2
9,8	5/16-24UNF	5/32	1,1	43,55	29,20	1,05	2 3/16
9,8	3/8-24UNF	3/16	1,1	52,50	32,80	1,30	2 1/4
9,8	3/8-24UNF	3/16	1,1	52,50	32,80	1,22	2 7/16

* Width across flats (hexagon socket)



→ Bearing insert - inch

with eccentric locking collar

ES200

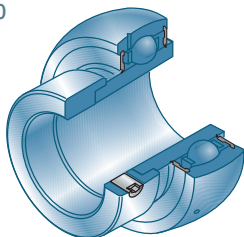

Shaft diameter		Bearing insert		Main dimensions [mm]					
d inch		D	C	B1	J2	B	s _{max}	D2	H1
1/2	ES201-08G2	40	12	19,1	13,5	28,6	6,5	27,2	3,6
5/8	ES202-10G2	40	12	19,1	13,5	28,6	6,5	27,2	3,6
11/16	ES203-11G2	40	12	19,1	13,5	28,6	6,5	27,2	3,6
3/4	ES204-12G2	47	14	21,4	13,5	30,9	7,5	32,4	4,0
7/8	ES205-14G2	52	15	21,4	13,5	30,9	7,5	37,4	4,3
15/16	ES205-15G2	52	15	21,4	13,5	30,9	7,5	37,4	4,3
1	ES205-16G2	52	15	21,4	13,5	30,9	7,5	37,4	4,3
1 1/8	ES206-18G2	62	16	23,8	15,9	35,7	9,0	44,1	5,0
1 3/16	ES206-19G2	62	16	23,8	15,9	35,7	9,0	44,1	5,0
1 1/4	ES206-20G2	62	16	23,8	15,9	35,7	9,0	44,1	5,0
1 3/8	ES207-22G2	72	17	25,4	17,5	38,9	9,5	51,1	5,7
1 7/16	ES207-23G2	72	17	25,4	17,5	38,9	9,5	51,1	5,7
1 1/2	ES208-24G2	80	18	30,2	18,3	43,7	11,0	58,0	6,2
1 5/8	ES209-26G2	85	19	30,2	18,3	43,7	11,0	63,5	6,5
1 11/16	ES209-27G2	85	19	30,2	18,3	43,7	11,0	63,5	6,5
1 3/4	ES209-28G2	85	19	30,2	18,3	43,7	11,0	63,5	6,5
1 7/8	ES210-30G2	90	20	30,2	18,3	43,7	11,0	67,2	6,5
1 15/16	ES210-31G2	90	20	30,2	18,3	43,7	11,0	67,2	6,5
2	ES211-32G2	100	24	32,5	20,7	48,4	12,0	74,5	7,2
2 3/16	ES211-35G2	100	24	32,5	20,7	48,4	12,0	74,5	7,2
2 1/4	ES212-36G2	110	24	33,4	22,3	49,3	12,0	82,0	8,0
2 7/16	ES212-39G2	110	24	33,4	22,3	49,3	12,0	82,0	8,0

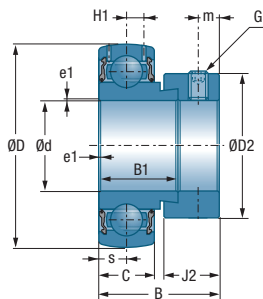

Main dimensions [mm]

Main dimensions [mm]				Dynamic load rating	Static load rating	Weight	Shaft diameter
m	G	a* inch	e1	C _r [kN]	C _{0r} [kN]	kg	d inch
5,0	1/4-28UNF	1/8	0,6	9,55	4,78	0,14	1/2
5,0	1/4-28UNF	1/8	0,6	9,55	4,78	0,13	5/8
5,0	1/4-28UNF	1/8	0,6	9,55	4,78	0,13	11/16
5,0	1/4-28UNF	1/8	0,6	12,80	6,65	0,15	3/4
5,0	1/4-28UNF	1/8	0,6	14,00	7,88	0,19	7/8
5,0	1/4-28UNF	1/8	0,6	14,00	7,88	0,19	15/16
5,0	1/4-28UNF	1/8	0,6	14,00	7,88	0,18	1
6,0	5/16-24UNF	5/32	0,6	19,50	11,20	0,35	1 1/8
6,0	5/16-24UNF	5/32	0,6	19,50	11,20	0,31	1 3/16
6,0	5/16-24UNF	5/32	0,6	19,50	11,20	0,28	1 1/4
6,5	5/16-24UNF	5/32	1,1	25,70	15,20	0,51	1 3/8
6,5	5/16-24UNF	5/32	1,1	25,70	15,20	0,48	1 7/16
6,5	5/16-24UNF	5/32	1,1	29,60	18,20	0,68	1 1/2
6,5	5/16-24UNF	5/32	1,1	31,85	20,80	0,82	1 5/8
6,5	5/16-24UNF	5/32	1,1	31,85	20,80	0,76	1 11/16
6,5	5/16-24UNF	5/32	1,1	31,85	20,80	0,73	1 3/4
6,5	5/16-24UNF	5/32	1,1	35,10	23,20	0,85	1 7/8
6,5	5/16-24UNF	5/32	1,1	35,10	23,20	0,83	1 15/16
8,0	3/8-24UNF	3/16	1,1	43,55	29,20	1,18	2
8,0	3/8-24UNF	3/16	1,1	43,55	29,20	0,81	2 3/16
8,0	3/8-24UNF	3/16	1,1	52,50	32,80	1,30	2 1/4
8,0	3/8-24UNF	3/16	1,1	52,50	32,80	1,09	2 7/16

* Width across flats (hexagon socket)



→ Bearing insert - inch

with eccentric locking collar

EX200

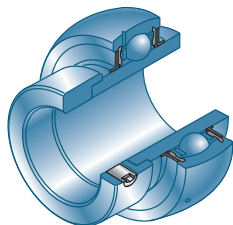

Shaft diameter		Bearing insert		Main dimensions [mm]						
d inch		D	C	B1	J2	B	s _{max}	D2	H1	
1/2	EX201-08G2	47	16	34,0	13,5	43,5	17,0	32,4	4,4	
5/8	EX202-10G2	47	16	34,0	13,5	43,5	17,0	32,4	4,4	
11/16	EX203-11G2	47	16	34,0	13,5	43,5	17,0	32,4	4,4	
3/4	EX204-12G2	47	16	34,0	13,5	43,5	17,0	32,4	4,4	
7/8	EX205-14G2	52	17	34,8	13,5	44,3	17,4	37,4	4,3	
15/16	EX205-15G2	52	17	34,8	13,5	44,3	17,4	37,4	4,3	
1	EX205-16G2	52	17	34,8	13,5	44,3	17,4	37,4	4,3	
1 1/8	EX206-18G2	62	19	36,4	15,9	48,3	18,2	44,1	5,0	
1 3/16	EX206-19G2	62	19	36,4	15,9	48,3	18,2	44,1	5,0	
1 1/4	EX206-20G2	62	19	36,4	15,9	48,3	18,2	44,1	5,0	
1 3/8	EX207-22G2	72	20	37,6	17,5	51,1	18,8	51,1	5,8	
1 7/16	EX207-23G2	72	20	37,6	17,5	51,1	18,8	51,1	5,8	
1 1/2	EX208-24G2	80	21	42,8	18,3	56,3	21,4	58,0	6,3	
1 5/8	EX209-26G2	85	22	42,8	18,3	56,3	21,4	63,5	6,8	
1 11/16	EX209-27G2	85	22	42,8	18,3	56,3	21,4	63,5	6,8	
1 3/4	EX209-28G2	85	22	42,8	18,3	56,3	21,4	63,5	6,8	
1 7/8	EX210-30G2	90	23	49,2	18,3	62,7	24,6	67,2	6,5	
1 15/16	EX210-31G2	90	23	49,2	18,3	62,7	24,6	67,2	6,5	
2	EX211-32G2	100	25	55,4	20,7	71,3	27,7	74,5	7,2	
2 3/16	EX211-35G2	100	25	55,4	20,7	71,3	27,7	74,5	7,2	
2 1/4	EX212-36G2	110	27	61,8	22,3	77,7	30,9	82,0	8,2	
2 7/16	EX212-39G2	110	27	61,8	22,3	77,7	30,9	82,0	8,2	
2 1/2	EX213-40G2	120	28	68,2	23,5	85,7	34,1	86,0	8,0	
2 11/16	EX214-43G2	125	30	68,2	23,5	85,7	34,1	96,8	9,0	
2 3/4	EX214-44G2	125	30	68,2	23,5	85,7	34,1	96,8	9,0	
2 15/16	EX215-47G2	130	30	74,6	23,9	92,1	37,3	102,0	9,0	
3	EX215-48G2	130	30	74,6	23,9	92,1	37,3	102,0	9,0	
3 1/4	EX217-52G2	150	35	53,2	27,0	73,2	23,4	119,0	11,0	
3 1/2	EX218-56G2	160	37	55,0	24,0	72,5	24,5	120,0	10,3	

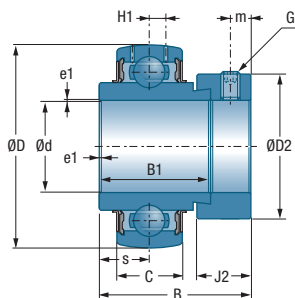

Main dimensions [mm]				Dynamic load rating	Static load rating	Weight	Shaft diameter
m	G	a* inch	e1	C _r [kN]	C _{0r} [kN]	kg	d inch
5,0	1/4-28UNF	1/8	0,6	12,80	6,65	0,29	1/2
5,0	1/4-28UNF	1/8	0,6	12,80	6,65	0,27	5/8
5,0	1/4-28UNF	1/8	0,6	12,80	6,65	0,24	11/16
5,0	1/4-28UNF	1/8	0,6	12,80	6,65	0,22	3/4
5,0	1/4-28UNF	1/8	0,6	14,00	7,88	0,25	7/8
5,0	1/4-28UNF	1/8	0,6	14,00	7,88	0,25	15/16
5,0	1/4-28UNF	1/8	0,6	14,00	7,88	0,24	1
6,0	5/16-24UNF	5/32	0,6	19,50	11,20	0,43	1 1/8
6,0	5/16-24UNF	5/32	0,6	19,50	11,20	0,40	1 3/16
6,0	5/16-24UNF	5/32	0,6	19,50	11,20	0,38	1 1/4
6,5	5/16-24UNF	5/32	1,1	25,70	15,20	0,61	1 3/8
6,5	5/16-24UNF	5/32	1,1	25,70	15,20	0,58	1 7/16
6,5	5/16-24UNF	5/32	1,1	29,60	18,20	0,83	1 1/2
6,5	5/16-24UNF	5/32	1,1	31,85	20,80	0,96	1 5/8
6,5	5/16-24UNF	5/32	1,1	31,85	20,80	0,91	1 11/16
6,5	5/16-24UNF	5/32	1,1	31,85	20,80	0,87	1 3/4
6,5	5/16-24UNF	5/32	1,1	35,10	23,20	1,10	1 7/8
6,5	5/16-24UNF	5/32	1,1	35,10	23,20	1,04	1 15/16
8,0	3/8-24UNF	3/16	1,5	43,55	29,20	1,58	2
8,0	3/8-24UNF	3/16	1,5	43,55	29,20	1,36	2 3/16
8,0	3/8-24UNF	3/16	1,5	52,50	32,80	2,03	2 1/4
8,0	3/8-24UNF	3/16	1,5	52,50	32,80	1,76	2 7/16
8,5	3/8-24UNF	3/16	1,5	57,20	40,00	2,51	2 1/2
8,5	3/8-24UNF	3/16	2,0	62,00	45,00	2,62	2 11/16
8,5	3/8-24UNF	3/16	2,0	62,00	45,00	2,58	2 3/4
8,5	3/8-24UNF	3/16	2,0	66,00	49,50	2,80	2 15/16
8,5	3/8-24UNF	3/16	2,0	66,00	49,50	2,74	3
10,0	7/16-20UNF	7/32	2,0	83,20	63,80	3,65	3 1/4
9,5	7/16-20UNF	7/32	2,0	96,00	71,50	5,00	3 1/2

* Width across flats (hexagon socket)



→ Bearing insert - inch

with adapter sleeve

UK200H

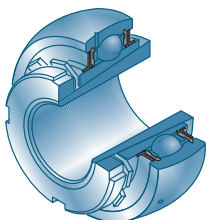

Shaft diameter inch	Bearing insert + adapter sleeve	Main dimensions [mm]							
		D	C	B1	c	B	d1	D1	D2
3/4	UK205G2H-12	52	17	21	8,0	35	25	34,0	38
7/8	UK206G2H-14	62	19	25	8,0	38	30	40,3	45
15/16	UK206G2H-15	62	19	25	8,0	38	30	40,3	45
1	UK206G2H-16	62	19	25	8,0	38	30	40,3	45
1 1/8	UK207G2H-18	72	20	27	9,0	43	35	48,0	52
1 3/16	UK207G2H-19	72	20	27	9,0	43	35	48,0	52
1 1/4	UK208G2H-20	80	21	29	10,0	46	40	53,0	58
1 3/8	UK208G2H-22	80	21	29	10,0	46	40	53,0	58
1 7/16	UK209G2H-23	85	22	30	11,0	50	45	57,2	65
1 1/2	UK209G2H-24	85	22	30	11,0	50	45	57,2	65
1 5/8	UK210G2H-26	90	23	31	12,0	55	50	61,8	70
1 11/16	UK210G2H-27	90	23	31	12,0	55	50	61,8	70
1 3/4	UK210G2H-28	90	23	31	12,0	55	50	61,8	70
1 7/8	UK211G2H-30	100	25	33	12,5	59	55	69,0	75
1 15/16	UK211G2H-31	100	25	33	12,5	59	55	69,0	75
2	UK211G2H-32	100	25	33	12,5	59	55	69,0	75
2 3/16	UK213G2H-35	120	28	36	14,0	65	65	82,0	85
2 1/4	UK213G2H-36	120	28	36	14,0	65	65	82,0	85
2 7/16	UK215G2H-39	130	30	41	15,0	73	75	91,5	98
2 1/2	UK215G2H-40	130	30	41	15,0	73	75	91,5	98
2 11/16	UK216G2H-43	140	33	44	17,0	78	80	98,0	105
2 3/4	UK216G2H-44	140	33	44	17,0	78	80	98,0	105
2 15/16	UK217G2H-47	150	35	44	18,0	82	85	105,1	110
3	UK217G2H-48	150	35	44	18,0	82	85	105,1	110

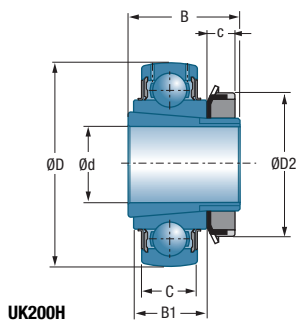
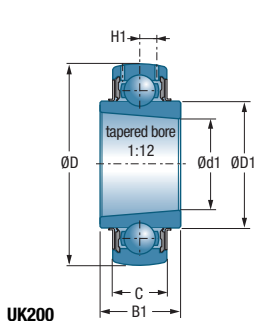

H1	Bearing insert	Adapter sleeve	Dynamic load rating C_r [kN]	Static load rating C_{0r} [kN]	Weight, total Bearing insert + adapter sleeve kg	Weight Bearing insert kg	Shaft diameter inch
4,3	UK205G2	H2305-12	14,00	7,88	0,24	0,15	3/4
5,0	UK206G2	H2306-14	19,50	11,20	0,40	0,25	7/8
5,0	UK206G2	H2306-15	19,50	11,20	0,39	0,25	15/16
5,0	UK206G2	H2306-16	19,50	11,20	0,36	0,25	1
5,8	UK207G2	H2307-18	25,70	15,20	0,55	0,37	1 1/8
5,8	UK207G2	H2307-19	25,70	15,20	0,53	0,37	1 3/16
6,3	UK208G2	H2308-20	29,60	18,20	0,76	0,48	1 1/4
6,3	UK208G2	H2308-22	29,60	18,20	0,74	0,48	1 3/8
6,8	UK209G2	H2309-23	31,85	20,80	0,80	0,53	1 7/16
6,8	UK209G2	H2309-24	31,85	20,80	0,84	0,53	1 1/2
6,5	UK210G2	H2310-26	35,10	23,20	1,00	0,59	1 5/8
6,5	UK210G2	H2310-27	35,10	23,20	0,99	0,59	1 11/16
6,5	UK210G2	H2310-28	35,10	23,20	0,95	0,59	1 3/4
7,2	UK211G2	H2311-30	43,55	29,20	1,20	0,77	1 7/8
7,2	UK211G2	H2311-31	43,55	29,20	1,19	0,77	1 15/16
7,2	UK211G2	H2311-32	43,55	29,20	1,13	0,77	2
8,0	UK213G2	H2313-35	57,20	40,00	2,11	1,36	2 3/16
8,0	UK213G2	H2313-36	57,20	40,00	2,01	1,36	2 1/4
9,0	UK215G2	H2315-39	66,00	49,50	2,82	1,67	2 7/16
9,0	UK215G2	H2315-40	66,00	49,50	2,81	1,67	2 1/2
10,3	UK216G2	H2316-43	72,50	54,20	3,26	1,96	2 11/16
10,3	UK216G2	H2316-44	72,50	54,20	3,16	1,96	2 3/4
11,0	UK217G2	H2317-47	83,20	63,80	3,82	2,42	2 15/16
11,0	UK217G2	H2317-48	83,20	63,80	3,72	2,42	3

For the size of the appropriate hook spanner refer on page 22 in our ball bearing catalogue (TC09).



→ Bearing insert - inch

with set screws

UC300

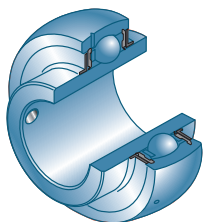

Shaft diameter		Bearing insert		Main dimensions [mm]			
d inch		D	C	B1	s _{max}	D1	H1
7/8	UC305-14G2	62	21	38	15	35,4	6,2
15/16	UC305-15G2	62	21	38	15	35,4	6,2
1	UC305-16G2	62	21	38	15	35,4	6,2
1 1/8	UC306-18G2	72	24	43	17	44,6	6,5
1 3/16	UC306-19G2	72	24	43	17	44,6	6,5
1 1/4	UC307-20G2	80	25	48	19	48,9	7,2
1 3/8	UC307-22G2	80	25	48	19	48,9	7,2
1 7/16	UC307-23G2	80	25	48	19	48,9	7,2
1 1/2	UC308-24G2	90	28	52	19	56,5	8,5
1 5/8	UC309-26G2	100	30	57	22	61,8	9,0
1 11/16	UC309-27G2	100	30	57	22	61,8	9,0
1 3/4	UC309-28G2	100	30	57	22	61,8	9,0
1 7/8	UC310-30G2	110	32	61	22	68,7	9,9
1 15/16	UC310-31G2	110	32	61	22	68,7	9,9
2	UC311-32G2	120	34	66	25	74,9	10,6
2 3/16	UC311-35G2	120	34	66	25	74,9	10,6
2 1/4	UC312-36G2	130	36	71	26	81,0	11,3
2 7/16	UC312-39G2	130	36	71	26	81,0	11,3
2 1/2	UC313-40G2	140	38	75	30	87,5	12,1
2 11/16	UC314-43G2	150	40	78	33	94,0	12,8
2 3/4	UC314-44G2	150	40	78	33	94,0	12,8
2 15/16	UC315-47G2	160	42	82	32	100,5	13,5
3	UC315-48G2	160	42	82	32	100,5	13,5
3 1/4	UC317-52G2	180	46	96	40	114,0	15,5
3 1/2	UC318-56G2	190	48	96	40	120,0	16,5
3 15/16	UC320-63G2	215	54	108	42	134,5	19,0

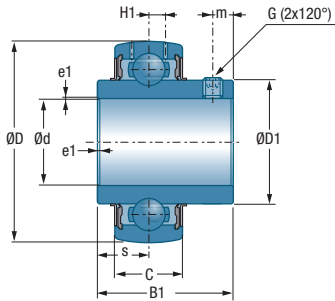

Main dimensions [mm]

Main dimensions [mm]				Dynamic load rating	Static load rating	Weight	Shaft diameter
m	G	a* inch	e1	C _r [kN]	C _{0r} [kN]	kg	d inch
6	1/4-28UNF	1/8	1,5	22,36	11,50	0,35	7/8
6	1/4-28UNF	1/8	1,5	22,36	11,50	0,35	15/16
6	1/4-28UNF	1/8	1,5	22,36	11,50	0,34	1
6	1/4-28UNF	1/8	1,5	27,00	15,20	0,58	1 1/8
6	1/4-28UNF	1/8	1,5	27,00	15,20	0,56	1 3/16
8	5/16-24UNF	5/32	2,0	33,50	19,20	0,77	1 1/4
8	5/16-24UNF	5/32	2,0	33,50	19,20	0,71	1 3/8
8	5/16-24UNF	5/32	2,0	33,50	19,20	0,70	1 7/16
10	3/8-24UNF	3/16	2,0	40,56	24,00	1,00	1 1/2
10	3/8-24UNF	3/16	2,0	53,00	31,80	1,36	1 5/8
10	3/8-24UNF	3/16	2,0	53,00	31,80	1,33	1 11/16
10	3/8-24UNF	3/16	2,0	53,00	31,80	1,30	1 3/4
12	7/16-20UNF	7/32	2,0	62,00	37,80	1,74	1 7/8
12	7/16-20UNF	7/32	2,0	62,00	37,80	1,68	1 15/16
12	7/16-20UNF	7/32	2,0	71,50	44,80	2,08	2
12	7/16-20UNF	7/32	2,0	71,50	44,80	1,87	2 3/16
12	7/16-20UNF	7/32	2,0	81,60	51,80	2,65	2 1/4
12	7/16-20UNF	7/32	2,0	81,60	51,80	2,50	2 7/16
12	7/16-20UNF	7/32	2,0	93,86	60,50	3,30	2 1/2
12	7/16-20UNF	7/32	2,5	104,26	68,00	4,00	2 11/16
12	7/16-20UNF	7/32	2,5	104,26	68,00	3,96	2 3/4
14	1/2-20UNF	1/4	2,5	113,36	76,80	4,29	2 15/16
14	1/2-20UNF	1/4	2,5	113,36	76,80	4,24	3
16	5/8-18UNF	5/16	3,0	132,60	96,50	6,76	3 1/4
16	5/8-18UNF	5/16	3,5	143,00	108,00	8,03	3 1/2
18	5/8-18UNF	5/16	3,5	171,60	140,00	11,00	3 15/16

* Width across flats (hexagon socket)



→ Bearing insert - inch

with eccentric locking collar

EX300

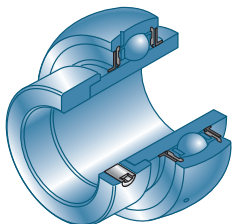

d inch	Bearing insert	Main dimensions [mm]							
		D	C	B1	J2	B	s _{max}	D2	H1
7/8	EX305-14G2	62	21	34,9	15,9	46,8	16,7	42,8	6,2
15/16	EX305-15G2	62	21	34,9	15,9	46,8	16,7	42,8	6,2
1	EX305-16G2	62	21	34,9	15,9	46,8	16,7	42,8	6,2
1 1/8	EX306-18G2	72	24	36,5	17,5	50,0	17,5	50,0	6,5
1 3/16	EX306-19G2	72	24	36,5	17,5	50,0	17,5	50,0	6,5
1 1/4	EX307-20G2	80	25	38,1	17,5	51,6	18,3	55,0	7,2
1 3/8	EX307-22G2	80	25	38,1	17,5	51,6	18,3	55,0	7,2
1 7/16	EX307-23G2	80	25	38,1	17,5	51,6	18,3	55,0	7,2
1 1/2	EX308-24G2	90	28	41,3	20,6	57,1	19,8	63,5	8,5
1 5/8	EX309-26G2	100	30	42,9	20,6	58,7	19,8	70,0	9,0
1 11/16	EX309-27G2	100	30	42,9	20,6	58,7	19,8	70,0	9,0
1 3/4	EX309-28G2	100	30	42,9	20,6	58,7	19,8	70,0	9,0
1 7/8	EX310-30G2	110	32	49,2	22,2	66,6	24,6	76,2	9,9
1 15/16	EX310-31G2	110	32	49,2	22,2	66,6	24,6	76,2	9,9
2	EX311-32G2	120	34	55,6	22,2	73,0	27,8	83,0	10,6
2 3/16	EX311-35G2	120	34	55,6	22,2	73,0	27,8	83,0	10,6
2 1/4	EX312-36G2	130	36	61,9	23,9	79,4	31,0	89,0	11,3
2 7/16	EX312-39G2	130	36	61,9	23,9	79,4	31,0	89,0	11,3
2 1/2	EX313-40G2	140	38	65,1	27,0	85,7	32,5	97,0	12,1
2 11/16	EX314-43G2	150	40	68,3	30,2	92,1	34,2	102,0	12,8
2 3/4	EX314-44G2	150	40	68,3	30,2	92,1	34,2	102,0	12,8
2 15/16	EX315-47G2	160	42	74,6	31,8	100,0	37,3	113,0	13,5
3	EX315-48G2	160	42	74,6	31,8	100,0	37,3	113,0	13,5
3 1/4	EX317-52G2	180	46	84,1	31,8	109,5	42,0	127,0	15,5
3 1/2	EX318-56G2	190	48	87,3	36,5	87,3	43,6	133,0	16,5
3 15/16	EX320-63G2	215	54	100,0	36,5	128,6	50,0	146,0	19,0

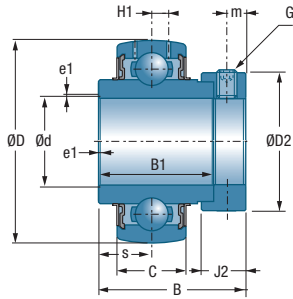

Main dimensions [mm]

Main dimensions [mm]				Dynamic load rating	Static load rating	Weight	Shaft diameter
m	G	a* inch	e1	C _r [kN]	C _{0r} [kN]	kg	d inch
6,0	5/16-24UNF	5/32	1,5	22,36	11,50	0,43	7/8
6,0	5/16-24UNF	5/32	1,5	22,36	11,50	0,43	15/16
6,0	5/16-24UNF	5/32	1,5	22,36	11,50	0,43	1
6,7	5/16-24UNF	5/32	1,5	27,00	15,20	0,71	1 1/8
6,7	5/16-24UNF	5/32	1,5	27,00	15,20	0,68	1 3/16
6,7	5/16-24UNF	5/32	2,0	33,50	19,20	0,86	1 1/4
6,7	5/16-24UNF	5/32	2,0	33,50	19,20	0,80	1 3/8
6,7	5/16-24UNF	5/32	2,0	33,50	19,20	0,78	1 7/16
8,0	3/8-24UNF	3/16	2,0	40,56	24,00	1,13	1 1/2
8,0	3/8-24UNF	3/16	2,0	53,00	31,80	1,57	1 5/8
8,0	3/8-24UNF	3/16	2,0	53,00	31,80	1,52	1 11/16
8,0	3/8-24UNF	3/16	2,0	53,00	31,80	1,47	1 3/4
8,7	3/8-24UNF	3/16	2,0	62,00	37,80	1,93	1 7/8
8,7	3/8-24UNF	3/16	2,0	62,00	37,80	1,88	1 15/16
9,0	3/8-24UNF	3/16	2,0	71,50	44,80	2,49	2
9,0	3/8-24UNF	3/16	2,0	71,50	44,80	2,24	2 3/16
9,0	3/8-24UNF	3/16	2,0	81,60	51,80	2,95	2 1/4
9,0	3/8-24UNF	3/16	2,0	81,60	51,80	2,86	2 7/16
11,5	7/16-20UNF	7/32	2,0	93,86	60,50	3,85	2 1/2
12,0	7/16-20UNF	7/32	2,5	104,26	68,00	4,45	2 11/16
12,0	7/16-20UNF	7/32	2,5	104,26	68,00	4,40	2 3/4
13,0	5/8-18UNF	5/16	2,5	113,36	76,80	5,40	2 15/16
13,0	5/8-18UNF	5/16	2,5	113,36	76,80	5,28	3
14,0	5/8-18UNF	5/16	3,0	132,60	96,50	7,88	3 1/4
15,0	3/4-16UNF	3/8	3,0	143,00	108,00	9,20	3 1/2
16,0	3/4-16UNF	3/8	3,5	171,60	140,00	12,85	3 15/16

* Width across flats (hexagon socket)



→ Bearing insert - inch

with adapter sleeve

UK300H

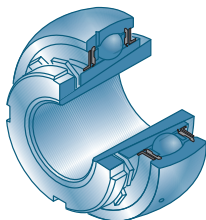

Shaft diameter	Bearing insert + adapter sleeve	Main dimensions [mm]							
		d inch	D	C	B1	c	B	d1	D1
3/4	UK305G2H-12	62	21	27	8,0	35	25	35,4	38
7/8	UK306G2H-14	72	24	30	8,0	38	30	44,6	45
15/16	UK306G2H-15	72	24	30	8,0	38	30	44,6	45
1	UK306G2H-16	72	24	30	8,0	38	30	44,6	45
1 1/8	UK307G2H-18	80	25	33	9,0	43	35	48,9	52
1 3/16	UK307G2H-19	80	25	33	9,0	43	35	48,9	52
1 1/4	UK308G2H-20	90	28	35	10,0	46	40	56,5	58
1 3/8	UK308G2H-22	90	28	35	10,0	46	40	56,5	58
1 7/16	UK309G2H-23	100	30	38	11,0	50	45	61,8	65
1 1/2	UK309G2H-24	100	30	38	11,0	50	45	61,8	65
1 5/8	UK310G2H-26	110	32	40	12,0	55	50	68,7	70
1 11/16	UK310G2H-27	110	32	40	12,0	55	50	68,7	70
1 3/4	UK310G2H-28	110	32	40	12,0	55	50	68,7	70
1 7/8	UK311G2H-30	120	34	43	12,5	59	55	74,9	75
1 15/16	UK311G2H-31	120	34	43	12,5	59	55	74,9	75
2	UK311G2H-32	120	34	43	12,5	59	55	74,9	75
2 3/16	UK313G2H-35	140	38	49	14,0	65	65	87,5	85
2 1/4	UK313G2H-36	140	38	49	14,0	65	65	87,5	85
2 7/16	UK315G2H-39	160	42	55	15,0	73	75	100,5	98
2 1/2	UK315G2H-40	160	42	55	15,0	73	75	100,5	98
2 11/16	UK316G2H-43	170	44	55	17,0	78	80	107,9	105
2 3/4	UK316G2H-44	170	44	55	17,0	78	80	107,9	105
2 15/16	UK317G2H-47	180	46	60	18,0	82	85	114,0	110
3	UK317G2H-48	180	46	60	18,0	82	85	114,0	110
3 1/4	UK319G2H-55	200	50	66	19,0	90	95	126,5	125
3 1/2	UK320G2H-56	215	54	68	20,0	97	100	134,5	130

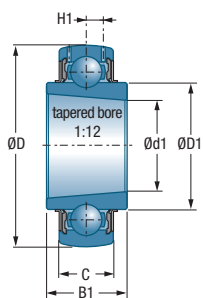

UK300

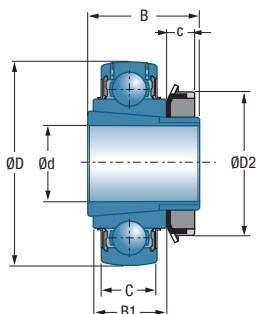

UK300H

H1	Bearing insert	Adapter sleeve	Dynamic load rating	Static load rating	Total weight Bearing insert + adapter sleeve	Bearing insert Weight	Shaft diameter
H1			C_r [kN]	C_{Or} [kN]	kg	kg	d inch
6,2	UK305G2	H2305-12	22,36	11,50	0,49	0,40	3/4
6,5	UK306G2	H2306-14	27,00	15,20	0,61	0,46	7/8
6,5	UK306G2	H2306-15	27,00	15,20	0,60	0,46	15/16
6,5	UK306G2	H2306-16	27,00	15,20	0,57	0,46	1
7,2	UK307G2	H2307-18	33,50	19,20	0,93	0,75	1 1/8
7,2	UK307G2	H2307-19	33,50	19,20	0,91	0,75	1 3/16
8,5	UK308G2	H2308-20	40,56	24,00	1,09	0,81	1 1/4
8,5	UK308G2	H2308-22	40,56	24,00	1,09	0,81	1 3/8
9,0	UK309G2	H2309-23	53,00	31,80	1,46	1,19	1 7/16
9,0	UK309G2	H2309-24	53,00	31,80	1,50	1,19	1 1/2
9,9	UK310G2	H2310-26	62,00	37,80	1,68	1,38	1 5/8
9,9	UK310G2	H2310-27	62,00	37,80	1,78	1,38	1 11/16
9,9	UK310G2	H2310-28	62,00	37,80	1,74	1,38	1 3/4
10,6	UK311G2	H2311-30	71,50	44,80	2,21	1,78	1 7/8
10,6	UK311G2	H2311-31	71,50	44,80	2,20	1,78	1 15/16
10,6	UK311G2	H2311-32	71,50	44,80	2,14	1,78	2
12,1	UK313G2	H2313-35	93,86	60,50	3,46	2,71	2 3/16
12,1	UK313G2	H2313-36	93,86	60,50	3,36	2,71	2 1/4
13,5	UK315G2	H2315-39	113,36	76,80	5,13	3,98	2 7/16
13,5	UK315G2	H2315-40	113,36	76,80	5,10	3,98	2 1/2
14,5	UK316G2	H2316-43	122,85	86,50	5,85	4,55	2 11/16
14,5	UK316G2	H2316-44	122,85	86,50	5,75	4,55	2 3/4
15,5	UK317G2	H2317-47	132,60	96,50	6,84	5,44	2 15/16
15,5	UK317G2	H2317-48	132,60	96,50	6,74	5,44	3
16,7	UK319G2	H2319-55	156,00	122,00	9,66	7,31	3 1/4
19,0	UK320G2	H2320-56	171,60	140,00	10,62	8,82	3 1/2

For the size of the appropriate hook spanner refer on page 22 in our ball bearing catalogue (TC09).



→ Bearing insert - inch

with cylindrical outer ring and set screws

CUC200

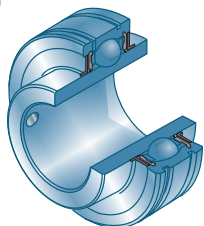

		Main dimensions [mm]							
Shaft diameter	Bearing insert	D	C	B1	s _{max}	D1	H1	m	N
d inch									
3/4	CUC204-12	47	17	31,0	12,7	29,0	4,0	4,5	1,35
7/8	CUC205-14	52	17	34,0	14,3	34,0	4,1	5,0	1,35
15/16	CUC205-15	52	17	34,0	14,3	34,0	4,1	5,0	1,35
1	CUC205-16	52	17	34,0	14,3	34,0	4,1	5,0	1,35
1 1/8	CUC206-18	62	19	38,1	15,9	40,3	4,2	5,5	1,90
1 3/16	CUC206-19	62	19	38,1	15,9	40,3	4,2	5,5	1,90
1 1/4	CUC206-20	62	19	38,1	15,9	40,3	4,2	5,5	1,90
1 3/8	CUC207-22	72	20	42,9	17,5	46,9	5,0	6,5	1,90
1 7/16	CUC207-23	72	20	42,9	17,5	46,9	5,0	6,5	1,90
1 1/2	CUC208-24	80	21	49,2	19,0	53,0	5,0	8,0	1,90
1 5/8	CUC209-26	85	22	49,2	19,0	57,2	5,1	8,0	1,90
1 11/16	CUC209-27	85	22	49,2	19,0	57,2	5,1	8,0	1,90
1 3/4	CUC209-28	85	22	49,2	19,0	57,2	5,1	8,0	1,90
1 7/8	CUC210-30	90	23	51,6	19,0	61,8	5,6	9,0	2,70
1 15/16	CUC210-31	90	23	51,6	19,0	61,8	5,6	9,0	2,70

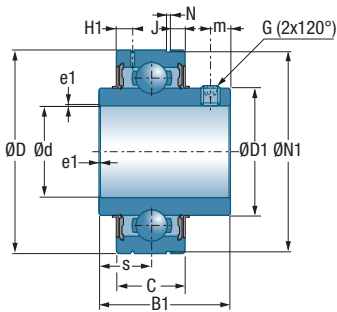

Main dimensions [mm]

Main dimensions [mm]					Dynamic load rating	Static load rating	Weight	Shaft diameter
J	N1	G	a* inch	e1	C _r [kN]	C _{0r} [kN]	kg	d inch
3,1	44,60	1/4-28UNF	1/8	0,6	12,80	6,65	0,20	3/4
3,2	49,73	1/4-28UNF	1/8	0,6	14,00	7,88	0,21	7/8
3,2	49,73	1/4-28UNF	1/8	0,6	14,00	7,88	0,21	15/16
3,2	49,73	1/4-28UNF	1/8	0,6	14,00	7,88	0,21	1
3,2	59,61	1/4-28UNF	1/8	0,6	19,50	11,20	0,34	1 1/8
3,2	59,61	1/4-28UNF	1/8	0,6	19,50	11,20	0,31	1 3/16
3,2	59,61	1/4-28UNF	1/8	0,6	19,50	11,20	0,30	1 1/4
3,3	68,81	5/16-24UNF	5/32	1,1	25,70	15,20	0,48	1 3/8
3,3	68,81	5/16-24UNF	5/32	1,1	25,70	15,20	0,45	1 7/16
3,4	76,81	5/16-24UNF	5/32	1,1	29,60	18,20	0,68	1 1/2
3,5	81,81	5/16-24UNF	5/32	1,1	31,85	20,80	0,78	1 5/8
3,5	81,81	5/16-24UNF	5/32	1,1	31,85	20,80	0,74	1 11/16
3,5	81,81	5/16-24UNF	5/32	1,1	31,85	20,80	0,70	1 3/4
3,7	86,79	3/8-24UNF	3/16	1,1	35,10	23,20	0,80	1 7/8
3,7	86,79	3/8-24UNF	3/16	1,1	35,10	23,20	0,82	1 15/16

* Width across flats (hexagon socket)



→ Bearing insert - inch

with cylindrical outer ring and set screws

CUS200

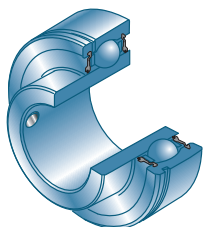

		Main dimensions [mm]							
Shaft diameter	Bearing insert	D	C	B1	s _{max}	D1	m	N	J
d inch									
3/4	CUS204-12	47	14	25,0	7,0	28,3	5	1,35	2,38
7/8	CUS205-14	52	15	27,0	7,5	34,0	5	1,35	2,38
15/16	CUS205-15	52	15	27,0	7,5	34,0	5	1,35	2,38
1	CUS205-16	52	15	27,0	7,5	34,0	5	1,35	2,38
1 1/8	CUS206-18	62	16	30,0	8,0	40,0	5,5	1,90	3,18
1 3/16	CUS206-19	62	16	30,0	8,0	40,0	5,5	1,90	3,18
1 1/4	CUS206-20	62	16	30,0	8,0	40,0	5,5	1,90	3,18
1 3/8	CUS207-22	72	17	32,0	8,5	46,9	6	1,90	3,18
1 7/16	CUS207-23	72	17	32,0	8,5	46,9	6	1,90	3,18
1 1/2	CUS208-24	80	18	34,0	9,0	52,4	8	1,90	3,18
1 5/8	CUS209-26	85	19	41,2	9,5	57,6	8	1,90	3,18
1 11/16	CUS209-27	85	19	41,2	9,5	57,6	8	1,90	3,18
1 3/4	CUS209-28	85	19	41,2	9,5	57,6	8	1,90	3,18
1 7/8	CUS210-30	90	20	43,5	10,0	63,2	9	2,70	3,70
1 15/16	CUS210-31	90	20	43,5	10,0	63,2	9	2,70	3,70

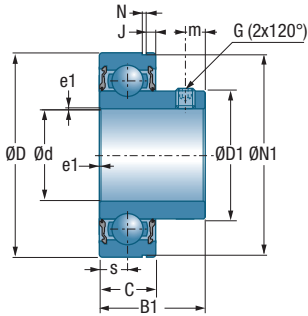

Main dimensions [mm]

Main dimensions [mm]				Dynamic load rating	Static load rating	Weight	Shaft diameter
N1	G	a* inch	e1	C _r [kN]	C _{0r} [kN]	kg	d inch
44,60	1/4-28UNF	1/8	1,0	12,80	6,65	0,13	3/4
49,73	1/4-28UNF	1/8	1,0	14,00	7,88	0,18	7/8
49,73	1/4-28UNF	1/8	1,0	14,00	7,88	0,18	15/16
49,73	1/4-28UNF	1/8	1,0	14,00	7,88	0,18	1
59,61	1/4-28UNF	1/8	1,0	19,50	11,20	0,28	1 1/8
59,61	1/4-28UNF	1/8	1,0	19,50	11,20	0,25	1 3/16
59,61	1/4-28UNF	1/8	1,0	19,50	11,20	0,24	1 1/4
68,81	1/4-28UNF	1/8	1,0	25,70	15,20	0,38	1 3/8
68,81	1/4-28UNF	1/8	1,0	25,70	15,20	0,37	1 7/16
76,81	5/16-24UNF	5/32	1,0	29,60	18,20	0,60	1 1/2
81,81	5/16-24UNF	5/32	1,5	31,85	20,80	0,75	1 5/8
81,81	5/16-24UNF	5/32	1,5	31,85	20,80	0,72	1 11/16
81,81	5/16-24UNF	5/32	1,5	31,85	20,80	0,67	1 3/4
86,79	5/16-24UNF	5/32	1,5	35,10	23,20	0,80	1 7/8
86,79	5/16-24UNF	5/32	1,5	35,10	23,20	0,78	1 15/16

* Width across flats (hexagon socket)



→ Bearing insert - inch

with cylindrical outer ring and eccentric locking collar

CES200

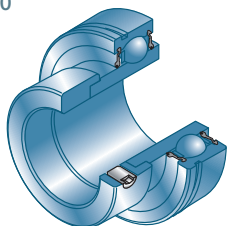

		Main dimensions [mm]								
Shaft diameter	Bearing insert	D	C	B1	J2	B	s _{max}	D2	m	N
d inch										
3/4	CES204-12	47	14	21,5	13,5	31,0	7,0	33,3	5,0	1,35
7/8	CES205-14	52	15	21,5	13,5	31,0	7,5	38,1	5,0	1,35
15/16	CES205-15	52	15	21,5	13,5	31,0	7,5	38,1	5,0	1,35
1	CES205-16	52	15	21,5	13,5	31,0	7,5	38,1	5,0	1,35
1 1/8	CES206-18	62	16	23,8	15,9	35,7	8,0	44,5	6,0	1,90
1 3/16	CES206-19	62	16	23,8	15,9	35,7	8,0	44,5	6,0	1,90
1 1/4	CES206-20	62	16	23,8	15,9	35,7	8,0	44,5	6,0	1,90
1 3/8	CES207-22	72	17	25,4	17,5	38,9	8,5	55,6	6,5	1,90
1 7/16	CES207-23	72	17	25,4	17,5	38,9	8,5	55,6	6,5	1,90
1 1/2	CES208-24	80	18	30,2	18,3	43,7	9,0	60,3	6,5	1,90
1 5/8	CES209-26	85	19	30,2	18,3	43,7	9,5	63,5	6,5	1,90
1 11/16	CES209-27	85	19	30,2	18,3	43,7	9,5	63,5	6,5	1,90
1 3/4	CES209-28	85	19	30,2	18,3	43,7	9,5	63,5	6,5	1,90
1 7/8	CES210-30	90	20	30,2	18,3	43,7	10,0	69,9	6,5	2,70
1 15/16	CES210-31	90	20	30,2	18,3	43,7	10,0	69,9	6,5	2,70

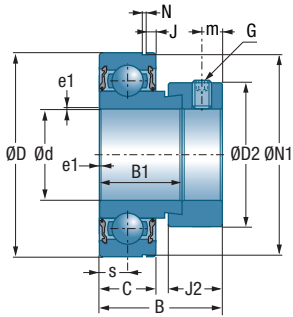

Main dimensions [mm]

Main dimensions [mm]					Dynamic load rating	Static load rating	Weight	Shaft diameter
J	N1	G	a* inch	e1	C _r [kN]	C _{0r} [kN]	kg	d inch
2,38	44,60	1/4-28UNF	1/8	1,0	12,80	6,65	0,15	3/4
2,38	49,73	1/4-28UNF	1/8	1,0	14,00	7,88	0,19	7/8
2,38	49,73	1/4-28UNF	1/8	1,0	14,00	7,88	0,19	15/16
2,38	49,73	1/4-28UNF	1/8	1,0	14,00	7,88	0,18	1
3,18	59,61	5/16-24UNF	5/32	1,0	19,50	11,20	0,35	1 1/8
3,18	59,61	5/16-24UNF	5/32	1,0	19,50	11,20	0,31	1 3/16
3,18	59,61	5/16-24UNF	5/32	1,0	19,50	11,20	0,28	1 1/4
3,18	68,81	5/16-24UNF	5/32	1,5	25,70	15,20	0,51	1 3/8
3,18	68,81	5/16-24UNF	5/32	1,5	25,70	15,20	0,48	1 7/16
3,18	76,81	5/16-24UNF	5/32	1,5	29,60	18,20	0,68	1 1/2
3,18	81,81	5/16-24UNF	5/32	1,5	31,85	20,80	0,82	1 5/8
3,18	81,81	5/16-24UNF	5/32	1,5	31,85	20,80	0,76	1 11/16
3,18	81,81	5/16-24UNF	5/32	1,5	31,85	20,80	0,73	1 3/4
3,70	86,79	5/16-24UNF	5/32	1,5	35,10	23,20	0,85	1 7/8
3,70	86,79	5/16-24UNF	5/32	1,5	35,10	23,20	0,83	1 15/16

* Width across flats (hexagon socket)



→ Bearing insert

with cylindrical outer ring and eccentric locking collar

CEX200

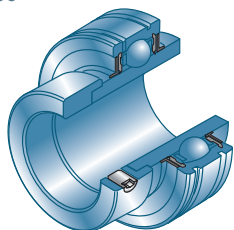

Shaft diameter		Bearing insert		Main dimensions [mm]						
d inch		D	C	B1	J2	B	s _{max}	D2	H1	m
3/4	CEX204-12	47	17	34,2	13,5	43,7	17,1	33,5	4,0	5,0
7/8	CEX205-14	52	17	34,9	13,5	44,4	17,5	38,1	4,1	5,0
15/16	CEX205-15	52	17	34,9	13,5	44,4	17,5	38,1	4,1	5,0
1	CEX205-16	52	17	34,9	13,5	44,4	17,5	38,1	4,1	5,0
1 1/8	CEX206-18	62	19	36,5	15,9	48,4	18,3	44,5	4,2	6,0
1 3/16	CEX206-19	62	19	36,5	15,9	48,4	18,3	44,5	4,2	6,0
1 1/4	CEX206-20	62	19	36,5	15,9	48,4	18,3	44,5	4,2	6,0
1 3/8	CEX207-22	72	20	37,6	17,5	51,1	18,8	55,5	5,0	6,5
1 7/16	CEX207-23	72	20	37,6	17,5	51,1	18,8	55,5	5,0	6,5
1 1/2	CEX208-24	80	21	42,8	18,3	56,3	21,4	60,3	5,0	6,5
1 5/8	CEX209-26	85	22	42,8	18,3	56,3	21,4	63,5	5,1	6,5
1 11/16	CEX209-27	85	22	42,8	18,3	56,3	21,4	63,5	5,1	6,5
1 3/4	CEX209-28	85	22	42,8	18,3	56,3	21,4	63,5	5,1	6,5
1 7/8	CEX210-30	90	24	49,2	18,3	62,7	24,6	69,5	5,6	6,5
1 15/16	CEX210-31	90	24	49,2	18,3	62,7	24,6	69,5	5,6	6,5

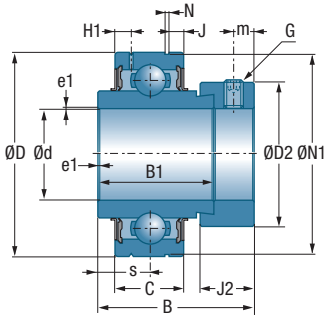

Main dimensions [mm]

Main dimensions [mm]						Dynamic load rating	Static load rating	Weight	Shaft diameter
N	J	N1	G	a* inch	e1	C _r [kN]	C _{0r} [kN]	kg	d inch
1,35	3,1	44,60	1/4-28UNF	1/8	1,0	12,80	6,65	0,22	3/4
1,35	3,2	49,73	1/4-28UNF	1/8	1,0	14,00	7,88	0,25	7
1,35	3,2	49,73	1/4-28UNF	1/8	1,0	14,00	7,88	0,25	15/16
1,35	3,2	49,73	1/4-28UNF	1/8	1,0	14,00	7,88	0,24	1
1,90	3,2	59,61	5/16-24UNF	5/32	1,0	19,50	11,20	0,43	1 1/8
1,90	3,2	59,61	5/16-24UNF	5/32	1,0	19,50	11,20	0,40	1 3/16
1,90	3,2	59,61	5/16-24UNF	5/32	1,0	19,50	11,20	0,38	1 1/4
1,90	3,3	68,81	5/16-24UNF	5/32	1,5	25,70	15,20	0,61	1 3/8
1,90	3,3	68,81	5/16-24UNF	5/32	1,5	25,70	15,20	0,58	1 7/16
1,90	3,4	76,81	5/16-24UNF	5/32	1,5	29,60	18,20	0,83	1 1/2
1,90	3,5	81,81	5/16-24UNF	5/32	1,5	31,85	20,80	0,96	1 5/8
1,90	3,5	81,81	5/16-24UNF	5/32	1,5	31,85	20,80	0,91	1 11/16
1,90	3,5	81,81	5/16-24UNF	5/32	1,5	31,85	20,80	0,87	1 3/4
3,70	3,7	86,79	5/16-24UNF	5/32	1,5	35,10	23,20	1,10	1 7/8
3,70	3,7	86,79	5/16-24UNF	5/32	1,5	35,10	23,20	1,04	1 15/16

* Width across flats (hexagon socket)



→ Pillow block unit

Housing SP200 with grease fitting
 Bearing insert SUC200 with set screws

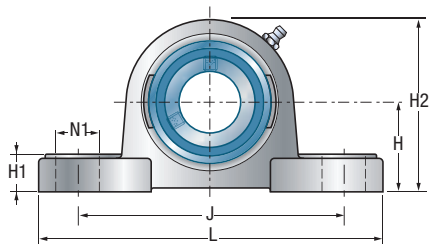

Shaft diameter	
metric	inch
12 - 60 mm	3/4 - 2 7/16

Shaft diameter	Unit
----------------	------

		Main dimensions [mm]							
d mm	d inch		L	J	B	H	H1	H2	s
12		SUCP201	126	95	31	33,3	15	65	12,7
15		SUCP202	126	95	31	33,3	15	65	12,7
17		SUCP203	126	95	31	33,3	15	65	12,7
20		SUCP204	126	95	31	33,3	15	65	12,7
	3/4	SUCP204-12	126	95	31	33,3	15	65	12,7
25		SUCP205	140	105	34,1	36,5	16	70	14,3
	1	SUCP205-16	140	105	34,1	36,5	16	70	14,3
30		SUCP206	165	121	38,1	42,9	18	83	15,9
	1 3/16	SUCP206-19	165	121	38,1	42,9	18	83	15,9
	1 1/4	SUCP206-20	165	121	38,1	42,9	18	83	15,9
35		SUCP207	167	127	42,9	47,6	19	94	17,5
	1 3/8	SUCP207-22	167	127	42,9	47,6	19	94	17,5
	1 7/16	SUCP207-23	167	127	42,9	47,6	19	94	17,5
40		SUCP208	184	136	49,2	49,2	19	100	19
	1 1/2	SUCP208-24	184	136	49,2	49,2	19	100	19
45		SUCP209	190	146	49,2	54	20	109	19
	1 3/4	SUCP209-28	190	146	49,2	54	20	109	19
50		SUCP210	206	159	51,6	57,2	22	114	19
	1 15/16	SUCP210-31	206	159	51,6	57,2	22	114	19
	2	SUCP211-32	219	171	55,6	63,5	23	126	22,2
55		SUCP211	219	171	55,6	63,5	23	126	22,2
	2 3/16	SUCP211-35	219	171	55,6	63,5	23	126	22,2
60		SUCP212	241	184	65,1	69,8	25	138	25,4
	2 7/16	SUCP212-39	241	184	65,1	69,8	25	138	25,4

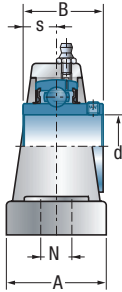

SUCP200

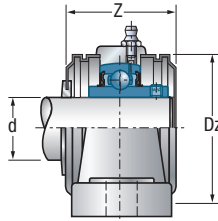

**open
SCO**

**closed
SCC**

with protective caps

Main dimensions [mm]

Main dimensions [mm]					Bearing insert	Housing	Total weight	Shaft diameter	
A	N	N1	Z _{max}	Dz			kg	d inch	d mm
38	13	19	45,6	54	SUC201	SP201	0,83		12
38	13	19	45,6	54	SUC202	SP202	0,80		15
38	13	19	45,6	54	SUC203	SP203	0,84		17
38	13	19	45,6	54	SUC204	SP204	0,82		20
38	13	19	45,6	54	SUC204-12	SP204	0,82	3/4	
38	13	19	47,8	60	SUC205	SP205	0,95		25
38	13	19	47,8	60	SUC205-16	SP205	0,95	1	
48	17	21	52,8	70	SUC206	SP206	1,58		30
48	17	21	52,8	70	SUC206-19	SP206	1,58	1 3/16	
48	17	21	52,8	70	SUC206-20	SP206	1,58	1 1/4	
48	17	21	57,4	80	SUC207	SP207	1,95		35
48	17	21	57,4	80	SUC207-22	SP207	1,95	1 3/8	
48	17	21	57,4	80	SUC207-23	SP207	1,95	1 7/16	
54	17	23	66,8	88	SUC208	SP208	2,39		40
54	17	23	66,8	88	SUC208-24	SP208	2,39	1 1/2	
54	17	23	67,8	95	SUC209	SP209	2,72		45
54	17	23	67,8	95	SUC209-28	SP209	2,72	1 3/4	
60	20	25	75,6	100	SUC210	SP210	3,28		50
60	20	25	75,6	100	SUC210-31	SP210	3,28	1 15/16	
60	20	25	75,2	110	SUC211-32	SP211	4,12	2	
60	20	25	75,2	110	SUC211	SP211	4,12		55
60	20	25	75,2	110	SUC211-35	SP211	4,12	2 3/16	
70	20	25	87,8	120	SUC212	SP212	5,71		60
70	20	25	87,8	120	SUC212-39	SP212	5,71	2 7/16	



→ Pillow block unit

Housing SP200 with grease fitting
 Bearing insert SES200 with eccentric locking collar

Shaft diameter	
metric	inch
12 - 60 mm	3/4 - 2

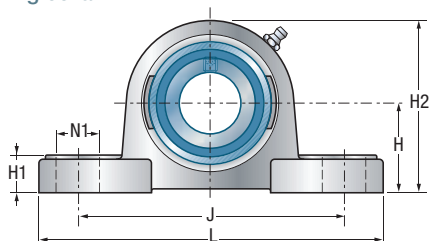

Shaft diameter		Unit	Main dimensions [mm]						
d mm	d inch		L	J	B	H	H1	H2	s
12		SESP201	126	95	28,6	30,2	15	63	6
15		SESP202	126	95	28,6	30,2	15	63	6
17		SESP203	126	95	28,6	30,2	15	63	6
20		SESP204	126	95	31	33,3	15	65	7
	3/4	SESP204-12	126	95	31	33,3	15	65	7
25		SESP205	140	105	31	36,5	16	70	7,5
	1	SESP205-16	140	105	31	36,5	16	70	7,5
30		SESP206	165	121	35,7	42,9	18	83	8
	1 3/16	SESP206-19	165	121	35,7	42,9	18	83	8
	1 1/4	SESP206-20	165	121	35,7	42,9	18	83	8
35		SESP207	167	127	38,9	47,6	19	94	8,5
	1 3/8	SESP207-22	167	127	38,9	47,6	19	94	8,5
	1 7/16	SESP207-23	167	127	38,9	47,6	19	94	8,5
40		SESP208	184	136	43,7	49,2	19	100	9
	1 1/2	SESP208-24	184	136	43,7	49,2	19	100	9
45		SESP209	190	146	43,7	54	20	109	9,5
	1 3/4	SESP209-28	190	146	43,7	54	20	109	9,5
50		SESP210	206	159	43,7	57,2	22	114	10
	1 15/16	SESP210-31	206	159	43,7	57,2	22	114	10
	2	SESP211-32	219	171	48,4	63,5	23	126	10,5
55		SESP211	219	171	48,4	63,5	23	126	10,5
60		SESP212	241	184	53,1	69,8	25	138	11

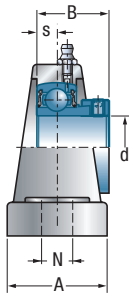

SESP200

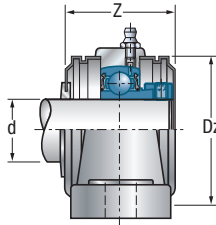

open
SCOE

closed
SCCE

with protective caps

Main dimensions [mm]

Main dimensions [mm]					Bearing insert	Housing	Total weight	Shaft diameter	
A	N	N1	Z _{max}	Dz			kg	d inch	d mm
38	13	19	59,0	46	SES201	SP201	0,80		12
38	13	19	59,0	46	SES202	SP202	0,79		15
38	13	19	59,0	46	SES203	SP203	0,77		17
38	13	19	64,0	54	SES204	SP204	0,83		20
38	13	19	64,0	54	SES204-12	SP204	0,83	3/4	
38	13	19	65,0	60	SES205	SP205	0,94		25
38	13	19	65,0	60	SES205-16	SP205	0,94	1	
48	17	21	71,0	70	SES206	SP206	1,57		30
48	17	21	71,0	70	SES206-19	SP206	1,57	1 3/16	
48	17	21	71,0	70	SES206-20	SP206	1,57	1 1/4	
48	17	21	76,0	80	SES207	SP207	1,98		35
48	17	21	76,0	80	SES207-22	SP207	1,98	1 3/8	
48	17	21	76,0	80	SES207-23	SP207	1,98	1 7/16	
54	17	23	79,0	88	SES208	SP208	2,40		40
54	17	23	79,0	88	SES208-24	SP208	2,40	1 1/2	
54	17	23	82,0	95	SES209	SP209	2,69		45
54	17	23	82,0	95	SES209-28	SP209	2,69	1 3/4	
60	20	25	91,0	100	SES210	SP210	3,26		50
60	20	25	91,0	100	SES210-31	SP210	3,26	1 15/16	
60	20	25	102,0	110	SES211-32	SP211	4,08	2	
60	20	25	102,0	110	SES211	SP211	4,08		55
70	20	25	109,0	120	SES212	SP212	5,58		60



→ Tapped base pillow block units

Housing SPA200 with grease fitting
 Bearing insert SUC200 with set screws

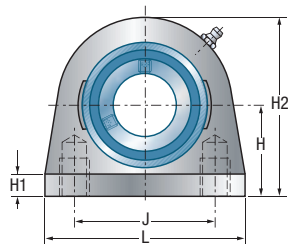

Shaft diameter	
metric	inch
12 - 50 mm	3/4 - 1 15/16

Shaft diameter		Unit	Main dimensions [mm]							
d mm	d inch		L	J	B	H	H1	H2	s	
12		SUCPA201	73	50,8	31	33,3	11	65	12,7	
15		SUCPA202	73	50,8	31	33,3	11	65	12,7	
17		SUCPA203	73	50,8	31	33,3	11	65	12,7	
20		SUCPA204	73	50,8	31	33,3	11	65	12,7	
	3/4	SUCPA204-12	73	50,8	31	33,3	11	65	12,7	
25		SUCPA205	76	50,8	34,1	36,5	11	71	14,3	
	1	SUCPA205-16	76	50,8	34,1	36,5	11	71	14,3	
30		SUCPA206	102	76,2	38,1	42,9	12	86	15,9	
	1 3/16	SUCPA206-19	102	76,2	38,1	42,9	12	86	15,9	
	1 1/4	SUCPA206-20	102	76,2	38,1	42,9	12	86	15,9	
35		SUCPA207	108	82,6	42,9	47,6	12	95	17,5	
	1 3/8	SUCPA207-22	108	82,6	42,9	47,6	12	95	17,5	
	1 7/16	SUCPA207-23	108	82,6	42,9	47,6	12	95	17,5	
40		SUCPA208	117	89	49,2	49,2	13	100	19	
	1 1/2	SUCPA208-24	117	89	49,2	49,2	13	100	19	
45		SUCPA209	127	95,3	49,2	54	13	108	19	
	1 3/4	SUCPA209-28	127	95,3	49,2	54	13	108	19	
50		SUCPA210	140	101,6	51,6	57,2	13	117	19	
	1 15/16	SUCPA210-31	140	101,6	51,6	57,2	13	117	19	

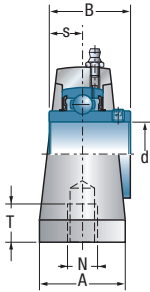

SUCPA200

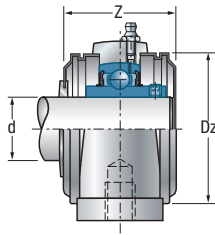

open SCO closed SCC

with protective caps

Main dimensions [mm]

Main dimensions [mm]					Bearing insert	Housing	Total weight	Shaft diameter	
A	N	T	Z _{max}	Dz			kg	d inch	d mm
38	M8	13	45,6	54	SUC201	SPA201	0,73		12
38	M8	13	45,6	54	SUC202	SPA202	0,71		15
38	M8	13	45,6	54	SUC203	SPA203	0,70		17
38	M8	13	45,6	54	SUC204	SPA204	0,68		20
38	M8	13	45,6	54	SUC204-12	SPA204	0,68	3/4	
38	M10	13	47,8	60	SUC205	SPA205	0,78		25
38	M10	13	47,8	60	SUC205-16	SPA205	0,78	1	
38	M10	16	52,8	70	SUC206	SPA206	1,30		30
38	M10	16	52,8	70	SUC206-19	SPA206	1,30	1 3/16	
38	M10	16	52,8	70	SUC206-20	SPA206	1,30	1 1/4	
48	M10	19	57,4	80	SUC207	SPA207	1,72		35
48	M10	19	57,4	80	SUC207-22	SPA207	1,72	1 3/8	
48	M10	19	57,4	80	SUC207-23	SPA207	1,72	1 7/16	
48	M12	19	66,8	88	SUC208	SPA208	1,91		40
48	M12	19	66,8	88	SUC208-24	SPA208	1,91	1 1/2	
51	M12	19	67,8	95	SUC209	SPA209	2,33		45
51	M12	19	67,8	95	SUC209-28	SPA209	2,33	1 3/4	
51	M16	19	75,6	100	SUC210	SPA210	2,83		50
51	M16	19	75,6	100	SUC210-31	SPA210	2,83	1 15/16	



→ Tapped base pillow block units

Housing SPA200 with grease fitting
 Bearing insert SES200 with eccentric locking collar

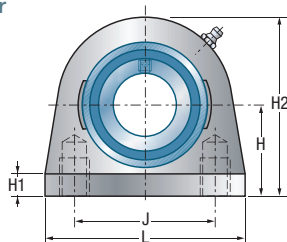

Shaft diameter	
metric	inch
12 - 50 mm	3/4 - 1 15/16

Shaft diameter		Unit	Main dimensions [mm]						
d mm	d inch		L	J	B	H	H1	H2	s
12		SESPA201	73	50,8	28,6	30,2	11	62	6
15		SESPA202	73	50,8	28,6	30,2	11	62	6
17		SESPA203	73	50,8	28,6	30,2	11	62	6
20		SESPA204	73	50,8	31	33,3	11	65	7
	3/4	SESPA204-12	73	50,8	31	33,3	11	65	7
25		SESPA205	76	50,8	31	36,5	11	71	7,5
	1	SESPA205-16	76	50,8	31	36,5	11	71	7,5
30		SESPA206	102	76,2	35,7	42,9	12	86	8
	1 3/16	SESPA206-19	102	76,2	35,7	42,9	12	86	8
	1 1/4	SESPA206-20	102	76,2	35,7	42,9	12	86	8
35		SESPA207	108	82,6	38,9	47,6	12	95	8,5
	1 3/8	SESPA207-22	108	82,6	38,9	47,6	12	95	8,5
	1 7/16	SESPA207-23	108	82,6	38,9	47,6	12	95	8,5
40		SESPA208	117	89	43,7	49,2	13	100	9
	1 1/2	SESPA208-24	117	89	43,7	49,2	13	100	9
45		SESPA209	127	95,3	43,7	54	13	108	9,5
	1 3/4	SESPA209-28	127	95,3	43,7	54	13	108	9,5
50		SESPA210	140	101,6	43,7	57,2	13	117	10
	1 15/16	SESPA210-31	140	101,6	43,7	57,2	13	117	10

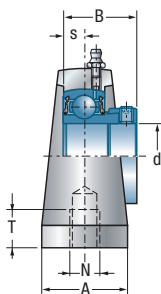

SES200

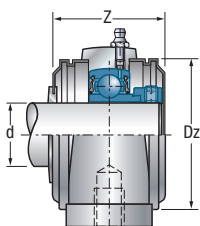

open SCOE closed SCCE
with protective caps

Main dimensions [mm]

Main dimensions [mm]					Bearing insert	Housing	Total weight	Shaft diameter	
A	N	T	Z _{max}	Dz			kg	d inch	d mm
38	M8	13	59,0	54	SES201	SPA201	0,65		12
38	M8	13	59,0	54	SES202	SPA202	0,64		15
38	M8	13	59,0	54	SES203	SPA203	0,63		17
38	M8	13	64,0	54	SES204	SPA204	0,69		20
38	M8	13	64,0	54	SES204-12	SPA204	0,69	3/4	
38	M10	13	65,0	60	SES205	SPA205	0,78		25
38	M10	13	65,0	60	SES205-16	SPA205	0,78	1	
38	M10	16	71,0	70	SES206	SPA206	1,30		30
38	M10	16	71,0	70	SES206-19	SPA206	1,30	1 3/16	
38	M10	16	71,0	70	SES206-20	SPA206	1,30	1 1/4	
48	M10	19	76,0	80	SES207	SPA207	1,75		35
48	M10	19	76,0	80	SES207-22	SPA207	1,75	3/8	
48	M10	19	76,0	80	SES207-23	SPA207	1,75	1 7/16	
48	M12	19	79,0	88	SES208	SPA208	1,92		40
48	M12	19	79,0	88	SES208-24	SPA208	1,92	1 1/2	
51	M12	19	82,0	95	SES209	SPA209	2,30		45
51	M12	19	82,0	95	SES209-28	SPA209	2,30	1 3/4	
51	M16	19	91,0	100	SES210	SPA210	2,81		50
51	M16	19	91,0	100	SES210-31	SPA210	2,81	1 15/16	



→ Four-bolt flanged units

Housing SF200 with grease fitting
 Bearing insert SUC200 with set screws

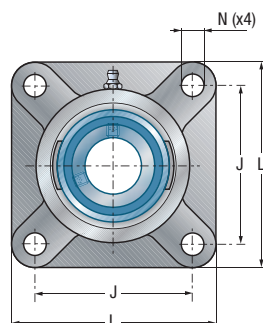

Shaft diameter	
metric	inch
12 - 60 mm	3/4 - 2 7/16

Shaft diameter	Unit
12	SUCF201
15	SUCF202
17	SUCF203
20	SUCF204
3/4	SUCF204-12
25	SUCF205
1	SUCF205-16
30	SUCF206
1 3/16	SUCF206-19
1 1/4	SUCF206-20
35	SUCF207
1 3/8	SUCF207-22
1 7/16	SUCF207-23
40	SUCF208
1 1/2	SUCF208-24
45	SUCF209
1 3/4	SUCF209-28
50	SUCF210
1 15/16	SUCF210-31
2	SUCF211-32
55	SUCF211
2 3/16	SUCF211-35
60	SUCF212
2 7/16	SUCF212-39

Main dimensions [mm]

d mm	d inch		L	J	B	A	A1	A2	s
12		SUCF201	86	64	31	15	25,5	12	12,7
15		SUCF202	86	64	31	15	25,5	12	12,7
17		SUCF203	86	64	31	15	25,5	12	12,7
20		SUCF204	86	64	31	15	25,5	12	12,7
	3/4	SUCF204-12	86	64	31	15	25,5	12	12,7
25		SUCF205	95	70	34,1	16	27	14	14,3
	1	SUCF205-16	95	70	34,1	16	27	14	14,3
30		SUCF206	108	83	38,1	18	30,5	14	15,9
	1 3/16	SUCF206-19	108	83	38,1	18	30,5	14	15,9
	1 1/4	SUCF206-20	108	83	38,1	18	30,5	14	15,9
35		SUCF207	116	92	42,9	19	33,5	14,5	17,5
	1 3/8	SUCF207-22	116	92	42,9	19	33,5	14,5	17,5
	1 7/16	SUCF207-23	116	92	42,9	19	33,5	14,5	17,5
40		SUCF208	130	102	49,2	21	36	14,5	19
	1 1/2	SUCF208-24	130	102	49,2	21	36	14,5	19
45		SUCF209	137	105	49,2	22	38	15,5	19
	1 3/4	SUCF209-28	137	105	49,2	22	38	15,5	19
50		SUCF210	143	111	51,6	22	40	15	19
	1 15/16	SUCF210-31	143	111	51,6	22	40	15	19
	2	SUCF211-32	162	130	55,6	25	44	20	22,2
55		SUCF211	162	130	55,6	25	44	20	22,2
	2 3/16	SUCF211-35	162	130	55,6	25	44	20	22,2
60		SUCF212	175	143	65,1	29	48	20	25,4
	2 7/16	SUCF212-39	175	143	65,1	29	48	20	25,4

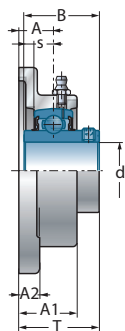

SUCF200

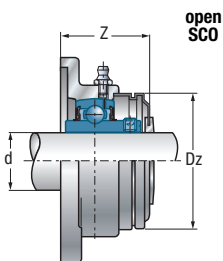

open
SCO

closed
SCC

with protective cap

Main dimensions [mm]

T	N	Z _{max}	Dz	Bearing insert	Housing	Total weight kg	Shaft diameter d inch	d mm
33,3	12	37,8	54	SUC201	SF201	0,66		12
33,3	12	37,8	54	SUC202	SF202	0,64		15
33,3	12	37,8	54	SUC203	SF203	0,63		17
33,3	12	37,8	54	SUC204	SF204	0,61		20
33,3	12	37,8	54	SUC204-12	SF204	0,61	3/4	
35,8	12	39,9	60	SUC205	SF205	0,82		25
35,8	12	39,9	60	SUC205-16	SF205	0,82	1	
40,2	12	44,4	70	SUC206	SF206	1,13		30
40,2	12	44,4	70	SUC206-19	SF206	1,13	1 3/16	
40,2	12	44,4	70	SUC206-20	SF206	1,13	1 1/4	
44,4	14	48,2	80	SUC207	SF207	1,41		35
44,4	14	48,2	80	SUC207-22	SF207	1,41	1 3/8	
44,4	14	48,2	80	SUC207-23	SF207	1,41	1 7/16	
51,2	16	54,4	88	SUC208	SF208	1,89		40
51,2	16	54,4	88	SUC208-24	SF208	1,89	1 1/2	
52,2	16	55,9	95	SUC209	SF209	2,32		45
52,2	16	55,9	95	SUC209-28	SF209	2,32	1 3/4	
54,6	16	59,8	100	SUC210	SF210	2,65		50
54,6	16	59,8	100	SUC210-31	SF210	2,65	1 15/16	
58,4	19	62,6	110	SUC211-32	SF211	4,06	2	
58,4	19	62,6	110	SUC211	SF211	4,06		55
58,4	19	62,6	110	SUC211-35	SF211	4,06	2 3/16	
68,7	19	72,9	120	SUC212	SF212	5,48		60
68,7	19	72,9	120	SUC212-39	SF212	5,48	2 7/16	



→ Four-bolt flanged units

Housing SF200 with grease fitting
 Bearing insert SES200 with eccentric locking collar

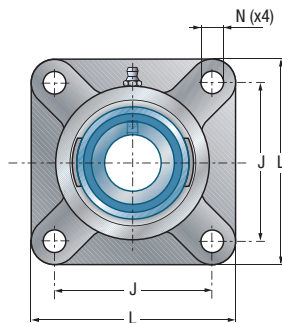

Shaft diameter	
metric	inch
12 - 60 mm	3/4 - 2 7/16

Shaft diameter	Unit
----------------	------

Main dimensions [mm]

d mm	d inch	Unit	L	J	B	A	A1	A2	s
12		SESF201	86	64	28,6	15	25,5	12	6
15		SESF202	86	64	28,6	15	25,5	12	6
17		SESF203	86	64	28,6	15	25,5	12	6
20		SESF204	86	64	31	15	25,5	12	7
	3/4	SESF204-12	86	64	31	15	25,5	12	7
25		SESF205	95	70	31	16	27	14	7,5
	1	SESF205-16	95	70	31	16	27	14	7,5
30		SESF206	108	83	35,7	18	30,5	14	8
	1 3/16	SESF206-19	108	83	35,7	18	30,5	14	8
	1 1/4	SESF206-20	108	83	35,7	18	30,5	14	8
35		SESF207	116	92	38,9	19	33,5	14,5	8,5
	1 3/8	SESF207-22	116	92	38,9	19	33,5	14,5	8,5
	1 7/16	SESF207-23	116	92	38,9	19	33,5	14,5	8,5
40		SESF208	130	102	43,7	21	36	14,5	9
	1 1/2	SESF208-24	130	102	43,7	21	36	14,5	9
45		SESF209	137	105	43,7	22	38	15,5	9,5
	1 3/4	SESF209-28	137	105	43,7	22	38	15,5	9,5
50		SESF210	143	111	43,7	22	40	15	10
	1 15/16	SESF210-31	143	111	43,7	22	40	15	10
	2	SESF211-32	162	130	48,4	25	44	20	10,5
55		SESF211	162	130	48,4	25	44	20	10,5
60		SESF212	175	143	53,1	29	48	20	11

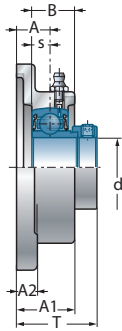

SESF200

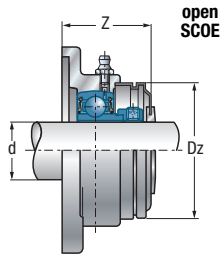

open
SCOE

closed
SCCE

with protective cap

Main dimensions [mm]

T	N	Z _{max}	Dz	Bearing insert	Housing	Total weight	Shaft diameter
						kg	d inch / d mm
37,6	12	47,0	46	SES201	SF201	0,59	12
37,6	12	47,0	46	SES202	SF202	0,57	15
37,6	12	47,0	46	SES203	SF203	0,56	17
39	12	47,0	54	SES204	SF204	0,62	20
39	12	47,0	54	SES204-12	SF204	0,62	3/4
39,5	12	48,5	60	SES205	SF205	0,82	25
39,5	12	48,5	60	SES205-16	SF205	0,82	1
45,7	12	53,5	70	SES206	SF206	1,13	30
45,7	12	53,5	70	SES206-19	SF206	1,13	1 3/16
45,7	12	53,5	70	SES206-20	SF206	1,13	1 1/4
49,4	14	57,5	80	SES207	SF207	1,44	35
49,4	14	57,5	80	SES207-22	SF207	1,44	1 3/8
49,4	14	57,5	80	SES207-23	SF207	1,44	1 7/16
55,7	16	60,5	88	SES208	SF208	1,90	40
55,7	16	60,5	88	SES208-24	SF208	1,90	1 1/2
56,2	16	63,0	95	SES209	SF209	2,29	45
56,2	16	63,0	95	SES209-28	SF209	2,29	1 3/4
55,7	16	67,5	100	SES210	SF210	2,62	50
55,7	16	67,5	100	SES210-31	SF210	2,62	1 15/16
62,9	19	76,0	110	SES211-32	SF211	4,03	2
62,9	19	76,0	110	SES211	SF211	4,03	55
71,1	19	83,5	120	SES212	SF212	5,35	60



→ Two-bolt flanged units

Two-bolt flanged units
Bearing insert

SFL200 with grease fitting
SUC200 with set screws

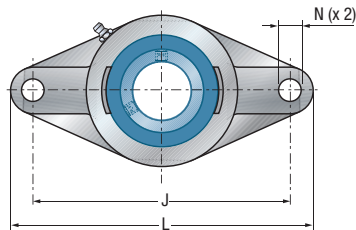

Shaft diameter	
metric	inch
12 - 50 mm	3/4 - 1 15/16

Shaft diameter		Unit
d mm	d inch	

			Main dimensions [mm]						
d mm	d inch	Unit	L	J	H	B	A	A1	A2
12		SUCFL201	112	90	60	31	15	25,5	12
15		SUCFL202	112	90	60	31	15	25,5	12
17		SUCFL203	112	90	60	31	15	25,5	12
20		SUCFL204	112	90	60	31	15	25,5	12
	3/4	SUCFL204-12	112	90	60	31	15	25,5	12
25		SUCFL205	125	99	68	34,1	16	27	13
	1	SUCFL205-16	125	99	68	34,1	16	27	13
30		SUCFL206	141	117	80	38,1	18	31	13
	1 3/16	SUCFL206-19	141	117	80	38,1	18	31	13
	1 1/4	SUCFL206-20	141	117	80	38,1	18	31	13
35		SUCFL207	156	130	90	42,9	19	33	15
	1 3/8	SUCFL207-22	156	130	90	42,9	19	33	15
	1 7/16	SUCFL207-23	156	130	90	42,9	19	33	15
40		SUCFL208	172	144	100	49,2	21	36	15
	1 1/2	SUCFL208-24	172	144	100	49,2	21	36	15
45		SUCFL209	180	148	108	49,2	22	38	15
	1 3/4	SUCFL209-28	180	148	108	49,2	22	38	15
50		SUCFL210	190	157	115	51,6	22	39	16
	1 15/16	SUCFL210-31	190	157	115	51,6	22	39	16

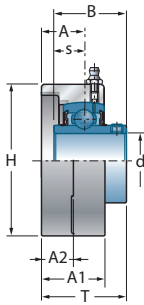

SUCFL200

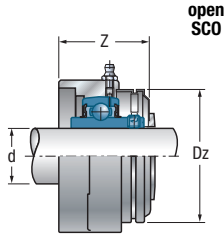

open
SCC

closed
SCC

with protective cap

Main dimensions [mm]

Main dimensions [mm]					Bearing insert	Housing	Total weight	Shaft diameter	
s	T	N	Z _{max}	Dz			kg	d inch	d mm
12,7	33,3	12	37,8	46	SUC201	SFL201	0,52		12
12,7	33,3	12	37,8	46	SUC202	SFL202	0,51		15
12,7	33,3	12	37,8	46	SUC203	SFL203	0,49		17
12,7	33,3	12	37,8	54	SUC204	SFL204	0,47		20
12,7	33,3	12	37,8	54	SUC204-12	SFL204	0,47	3/4	
14,3	35,8	16	39,9	60	SUC205	SFL205	0,60		25
14,3	35,8	16	39,9	60	SUC205-16	SFL205	0,60	1	
15,9	40,2	16	44,4	70	SUC206	SFL206	0,89		30
15,9	40,2	16	44,4	70	SUC206-19	SFL206	0,89	1 3/16	
15,9	40,2	16	44,4	70	SUC206-20	SFL206	0,89	1 1/4	
17,5	44,4	16	47,7	80	SUC207	SFL207	1,18		35
17,5	44,4	16	47,7	80	SUC207-22	SFL207	1,18	1 3/8	
17,5	44,4	16	47,7	80	SUC207-23	SFL207	1,18	1 7/16	
19	51,2	16	54,4	88	SUC208	SFL208	1,53		40
19	51,2	16	54,4	88	SUC208-24	SFL208	1,53	1 1/2	
19	52,2	19	55,9	95	SUC209	SFL209	1,81		45
19	52,2	19	55,9	95	SUC209-28	SFL209	1,81	1 3/4	
19	54,6	19	59,8	100	SUC210	SFL210	2,17		50
19	54,6	19	59,8	100	SUC210-31	SFL210	2,17	1 15/16	



→ Two-bolt flanged units

Two-bolt flanged units
Bearing insert

SFL200 with grease fitting
SES200 with eccentric locking collar

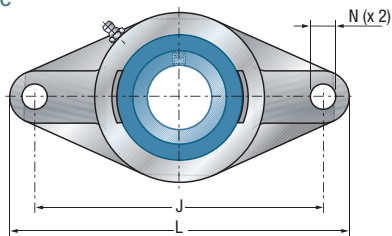

Shaft diameter	
metric	inch
12 - 50 mm	3/4 - 1 15/16

Shaft diameter		Unit
d mm	d inch	

Main dimensions [mm]

d mm	d inch	Unit	L	J	H	B	A	A1	A2
12		SESFL201	112	90	60	28,6	15	25,5	12
15		SESFL202	112	90	60	28,6	15	25,5	12
17		SESFL203	112	90	60	28,6	15	25,5	12
20		SESFL204	112	90	60	31	15	25,5	12
	3/4	SESFL204-12	112	90	60	31	15	25,5	12
25		SESFL205	125	99	68	31	16	27	13
	1	SESFL205-16	125	99	68	31	16	27	13
30		SESFL206	141	117	80	35,7	18	31	13
	1 3/16	SESFL206-19	141	117	80	35,7	18	31	13
	1 1/4	SESFL206-20	141	117	80	35,7	18	31	13
35		SESFL207	156	130	90	38,9	19	33	15
	1 3/8	SESFL207-22	156	130	90	38,9	19	33	15
	1 7/16	SESFL207-23	156	130	90	38,9	19	33	15
40		SESFL208	172	144	100	43,7	21	36	15
	1 1/2	SESFL208-24	172	144	100	43,7	21	36	15
45		SESFL209	180	148	108	43,7	22	38	15
	1 3/4	SESFL209-28	180	148	108	43,7	22	38	15
50		SESFL210	190	157	115	43,7	22	39	16
	1 15/16	SESFL210-31	190	157	115	43,7	22	39	16

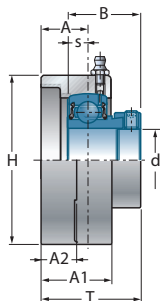

SESFL200

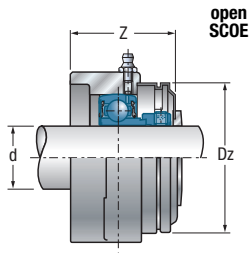

open
SCOE



closed
SCCE

with protective cap

Main dimensions [mm]

Main dimensions [mm]					Bearing insert	Housing	Total weight	Shaft diameter	
s	T	N	Z _{max}	Dz			kg	d inch	d mm
6	37,6	12	47,0	46	SES201	SFL201	0,45		12
6	37,6	12	47,0	46	SES202	SFL202	0,44		15
6	37,6	12	47,0	46	SES203	SFL203	0,42		17
7	39	12	47,0	54	SES204	SFL204	0,48		20
7	39	12	47,0	54	SES204-12	SFL204	0,48	3/4	
7,5	39,5	16	48,5	60	SES205	SFL205	0,60		25
7,5	39,5	16	48,5	60	SES205-16	SFL205	0,60	1	
8	45,7	16	53,5	70	SES206	SFL206	0,88		30
8	45,7	16	53,5	70	SES206-19	SFL206	0,88	1 3/16	
8	45,7	16	53,5	70	SES206-20	SFL206	0,88	1 1/4	
8,5	49,4	16	57,0	80	SES207	SFL207	1,21		35
8,5	49,4	16	57,0	80	SES207-22	SFL207	1,21	1 3/8	
8,5	49,4	16	57,0	80	SES207-23	SFL207	1,21	1 7/16	
9	55,7	16	60,5	88	SES208	SFL208	1,54		40
9	55,7	16	60,5	88	SES208-24	SFL208	1,54	1 1/2	
9,5	56,2	19	63,0	95	SES209	SFL209	1,79		45
9,5	56,2	19	63,0	95	SES209-28	SFL209	1,79	1 3/4	
10	55,7	19	67,5	100	SES210	SFL210	2,15		50
10	55,7	19	67,5	100	SES210-31	SFL210	2,15	1 15/16	



→ Take-up units

Housing ST200 with grease fitting
 Bearing insert SUC200 with set screws

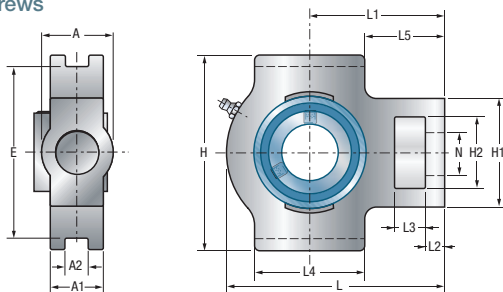

Shaft diameter	
metric	inch
12 - 50 mm	3/4 - 1 15/16

Shaft diameter	Unit
----------------	------

Main dimensions [mm]

d mm	d inch		L	H	A	B	A1	A2	E	s	L1	L2
12		SUCT201	94	89	32	31	21	12 ^{+0.2}	76 _{-0.5}	12,7	61	10
15		SUCT202	94	89	32	31	21	12 ^{+0.2}	76 _{-0.5}	12,7	61	10
17		SUCT203	94	89	32	31	21	12 ^{+0.2}	76 _{-0.5}	12,7	61	10
20		SUCT204	94	89	32	31	21	12 ^{+0.2}	76 _{-0.5}	12,7	61	10
	3/4	SUCT204-12	94	89	32	31	21	12 ^{+0.2}	76 _{-0.5}	12,7	61	10
25		SUCT205	97	89	32	34,1	24	12 ^{+0.2}	76 _{-0.5}	14,3	62	10
	1	SUCT205-16	97	89	32	34,1	24	12 ^{+0.2}	76 _{-0.5}	14,3	62	10
30		SUCT206	113	102	37	38,1	28	12 ^{+0.2}	89 _{-0.5}	15,9	70	10
	1 3/16	SUCT206-19	113	102	37	38,1	28	12 ^{+0.2}	89 _{-0.5}	15,9	70	10
	1 1/4	SUCT206-20	113	102	37	38,1	28	12 ^{+0.2}	89 _{-0.5}	15,9	70	10
35		SUCT207	129	102	37	42,9	30	12 ^{+0.2}	89 _{-0.5}	17,5	78	13
	1 3/8	SUCT207-22	129	102	37	42,9	30	12 ^{+0.2}	89 _{-0.5}	17,5	78	13
	1 7/16	SUCT207-23	129	102	37	42,9	30	12 ^{+0.2}	89 _{-0.5}	17,5	78	13
40		SUCT208	144	114	49	49,2	33	16 ^{+0.2}	102 _{-0.5}	19	88	16
	1 1/2	SUCT208-24	144	114	49	49,2	33	16 ^{+0.2}	102 _{-0.5}	19	88	16
45		SUCT209	144	117	49	49,2	35	16 ^{+0.2}	102 _{-0.5}	19	87	16
	1 3/4	SUCT209-28	144	117	49	49,2	35	16 ^{+0.2}	102 _{-0.5}	19	87	16
50		SUCT210	149	117	49	51,6	37	16 ^{+0.2}	102 _{-0.5}	19	90	16
	1 15/16	SUCT210-31	149	117	49	51,6	37	16 ^{+0.2}	102 _{-0.5}	19	90	16

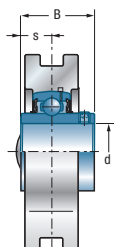

SUCT200

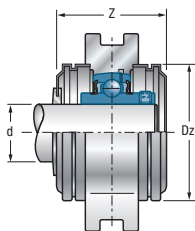

open SCO
closed SCC
with protective caps

Main dimensions [mm]

Main dimensions [mm]								Bearing insert	Housing	Total weight	Shaft diameter	
L3	L4	L5	N	H1	H2	Z _{max}	Dz			kg	d inch	d mm
16	51	35,5	19	51	32	45,6	54	SUC201	ST201	0,84		12
16	51	35,5	19	51	32	45,6	54	SUC202	ST202	0,83		15
16	51	35,5	19	51	32	45,6	54	SUC203	ST203	0,81		17
16	51	35,5	19	51	32	45,6	54	SUC204	ST204	0,79		20
16	51	35,5	19	51	32	45,6	54	SUC204-12	ST204	0,79	3/4	
16	51	36,5	19	51	32	47,8	60	SUC205	ST205	0,88		25
16	51	36,5	19	51	32	47,8	60	SUC205-16	ST205	0,88	1	
16	57	41,5	22	56	37	52,8	70	SUC206	ST206	1,36		30
16	57	41,5	22	56	37	52,8	70	SUC206-19	ST206	1,36	1 3/16	
16	57	41,5	22	56	37	52,8	70	SUC206-20	ST206	1,36	1 1/4	
16	64	46	22	64	37	57,4	80	SUC207	ST207	1,72		35
16	64	46	22	64	37	57,4	80	SUC207-22	ST207	1,72	1 3/8	
16	64	46	22	64	37	57,4	80	SUC207-23	ST207	1,72	1 7/16	
19	83	46,5	29	83	49	66,8	88	SUC208	ST208	2,54		40
19	83	46,5	29	83	49	66,8	88	SUC208-24	ST208	2,54	1 1/2	
19	83	45,5	29	83	49	67,8	95	SUC209	ST209	2,53		45
19	83	45,5	29	83	49	67,8	95	SUC209-28	ST209	2,53	1 3/4	
19	86	47	29	83	49	75,6	100	SUC210	ST210	2,68		50
19	86	47	29	83	49	75,6	100	SUC210-31	ST210	2,68	1 15/16	



→ Take-up units

Housing ST200 with grease fitting
 Bearing insert SES200 with eccentric locking collar

Shaft diameter	
metric	inch
12 - 50 mm	3/4 - 1 15/16

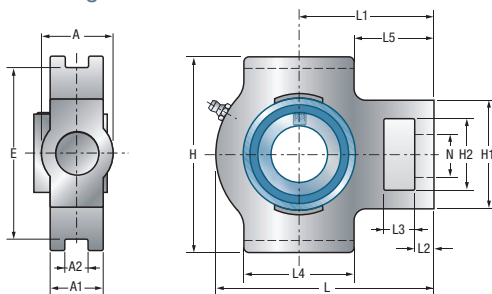

Shaft diameter		Unit	Main dimensions [mm]									
d mm	d inch		L	H	A	B	A1	A2	E	s	L1	L2
12		SEST201	94	89	32	28,6	21	12 ^{+0,2}	76 _{-0,5}	6	61	10
15		SEST202	94	89	32	28,6	21	12 ^{+0,2}	76 _{-0,5}	6	61	10
17		SEST203	94	89	32	28,6	21	12 ^{+0,2}	76 _{-0,5}	6	61	10
20		SEST204	94	89	32	31	21	12 ^{+0,2}	76 _{-0,5}	7	61	10
	3/4	SEST204-12	94	89	32	31	21	12 ^{+0,2}	76 _{-0,5}	7	61	10
25		SEST205	97	89	32	31	24	12 ^{+0,2}	76 _{-0,5}	7,5	62	10
	1	SEST205-16	97	89	32	31	24	12 ^{+0,2}	76 _{-0,5}	7,5	62	10
30		SEST206	113	102	37	35,7	28	12 ^{+0,2}	89 _{-0,5}	8	70	10
	1 3/16	SEST206-19	113	102	37	35,7	28	12 ^{+0,2}	89 _{-0,5}	8	70	10
	1 1/4	SEST206-20	113	102	37	35,7	28	12 ^{+0,2}	89 _{-0,5}	8	70	10
35		SEST207	129	102	37	38,9	30	12 ^{+0,2}	89 _{-0,5}	8,5	78	13
	1 3/8	SEST207-22	129	102	37	38,9	30	12 ^{+0,2}	89 _{-0,5}	8,5	78	13
	1 7/16	SEST207-23	129	102	37	38,9	30	12 ^{+0,2}	89 _{-0,5}	8,5	78	13
40		SEST208	144	114	49	43,7	33	16 ^{+0,2}	102 _{-0,5}	9	88	16
	1 1/2	SEST208-24	144	114	49	43,7	33	16 ^{+0,2}	102 _{-0,5}	9	88	16
45		SEST209	144	117	49	43,7	35	16 ^{+0,2}	102 _{-0,5}	9,5	87	16
	1 3/4	SEST209-28	144	117	49	43,7	35	16 ^{+0,2}	102 _{-0,5}	9,5	87	16
50		SEST210	149	117	49	43,7	37	16 ^{+0,2}	102 _{-0,5}	10	90	16
	1 15/16	SEST210-31	149	117	49	43,7	37	16 ^{+0,2}	102 _{-0,5}	10	90	16

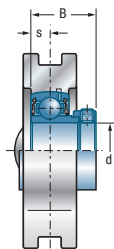

SEST200

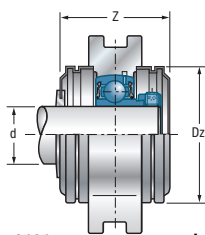

**open
SCOPE** **closed
SCOPE**
with protective cap

Main dimensions [mm]

Main dimensions [mm]								Bearing insert	Housing	Total weight	Shaft diameter	
L3	L4	L5	N	H1	H2	Z _{max}	Dz			kg	d inch	d mm
16	51	35,5	19	51	32	64,0	54	SES201	ST201	0,77		12
16	51	35,5	19	51	32	64,0	54	SES202	ST202	0,76		15
16	51	35,5	19	51	32	64,0	54	SES203	ST203	0,74		17
16	51	35,5	19	51	32	64,0	54	SES204	ST204	0,80		20
16	51	35,5	19	51	32	64,0	54	SES204-12	ST204	0,80	3/4	
16	51	36,5	19	51	32	65,0	60	SES205	ST205	0,88		25
16	51	36,5	19	51	32	65,0	60	SES205-16	ST205	0,88	1	
16	57	41,5	22	56	37	71,0	70	SES206	ST206	1,36		30
16	57	41,5	22	56	37	71,0	70	SES206-19	ST206	1,36	1 3/16	
16	57	41,5	22	56	37	71,0	70	SES206-20	ST206	1,36	1 1/4	
16	64	46	22	64	37	76,0	80	SES207	ST207	1,75		35
16	64	46	22	64	37	76,0	80	SES207-22	ST207	1,75	1 3/8	
16	64	46	22	64	37	76,0	80	SES207-23	ST207	1,75	1 7/16	
19	83	46,5	29	83	49	79,0	88	SES208	ST208	2,55		40
19	83	46,5	29	83	49	79,0	88	SES208-24	ST208	2,55	1 1/2	
19	83	45,5	29	83	49	82,0	95	SES209	ST209	2,50		45
19	83	45,5	29	83	49	82,0	95	SES209-28	ST209	2,50	1 3/4	
19	86	47	29	83	49	91,0	100	SES210	ST210	2,66		50
19	86	47	29	83	49	91,0	100	SES210-31	ST210	2,66	1 15/16	



➔ Bearing insert with set-screws - SUC200

Standard design with 2 set screws
and lubrication holes in the outer ring

Shaft diameter	
metric	inch
12 - 60 mm	3/4 - 2 7/16

Shaft diameter		Bearing insert	Main dimensions [mm]			
			D	B1	s	e1
d mm	d inch					
12		SUC201	47	31	12,7	0,5
15		SUC202	47	31	12,7	0,5
17		SUC203	47	31	12,7	0,5
20		SUC204	47	31	12,7	0,5
	3/4	SUC204-12	47	31	12,7	0,5
25		SUC205	52	34,1	14,3	0,5
	1	SUC205-16	52	34,1	14,3	0,5
30		SUC206	62	38,1	15,9	0,5
	1 3/16	SUC206-19	62	38,1	15,9	0,5
	1 1/4	SUC206-20	62	38,1	15,9	0,5
35		SUC207	72	42,9	17,5	1
	1 3/8	SUC207-22	72	42,9	17,5	1
	1 7/16	SUC207-23	72	42,9	17,5	1
40		SUC208	80	49,2	19	1
	1 1/2	SUC208-24	80	49,2	19	1
45		SUC209	85	49,2	19	1
	1 3/4	SUC209-28	85	49,2	19	1
50		SUC210	90	51,6	19	1
	1 15/16	SUC210-31	90	51,6	19	1
	2	SUC211-32	100	55,6	22,2	1
55		SUC211	100	55,6	22,2	1
	2 3/16	SUC211-35	100	55,6	22,2	1
60		SUC212	110	65,1	25,4	1
	2 7/16	SUC212-39	110	65,1	25,4	1

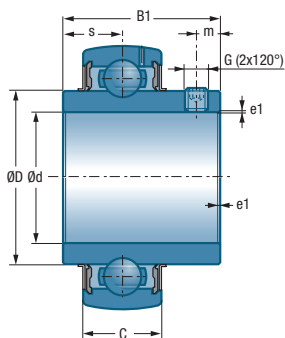

Main dimensions [mm]

Main dimensions [mm]			Bearing load rating (N)	Total weight	Shaft diameter		
C	G	m	C_r dyn.	C_{0r} stat.	kg	d inch	d mm
17	M6x1	5	10,10	6,80	0,21		12
17	M6x1	5	10,10	6,80	0,19		15
17	M6x1	5	10,10	6,80	0,18		17
17	M6x1	5	10,10	6,80	0,16		20
17	M6x1	5	10,10	6,80	0,16	3/4	
17	M6x1	5	11,00	8,00	0,20		25
17	M6x1	5	11,00	8,00	0,20	1	
19	M6x1	5	15,30	11,50	0,32		30
19	M6x1	5	15,30	11,50	0,32	1 3/16	
19	M6x1	5	15,30	11,50	0,32	1 1/4	
20	M8x1	6	20,10	15,60	0,47		35
20	M8x1	6	20,10	15,60	0,47	1 3/8	
20	M8x1	6	20,10	15,60	0,47	1 7/16	
21	M8x1	8	22,80	18,20	0,63		40
21	M8x1	8	22,80	18,20	0,63	1 1/2	
22	M10x1,25	8	25,70	20,80	0,69		45
22	M10x1,25	8	25,70	20,80	0,69	1 3/4	
24	M10x1,25	10	27,50	23,70	0,77		50
24	M10x1,25	10	27,50	23,70	0,77	1 15/16	
25	M10x1,25	10	34,00	25,50	1,06	2	
25	M10x1,25	10	34,00	25,50	1,06		55
25	M10x1,25	10	34,00	25,50	1,06	2 3/16	
27	M10x1,25	10	41,00	31,50	1,47		60
27	M10x1,25	10	41,00	31,50	1,47	2 7/16	



➔ Bearing inserts with eccentric locking collar - SES200

Standard design with eccentric locking collar and lubrication holes in the outer ring

Shaft diameter	
metric	inch
12 - 60 mm	3/4 - 2

			Main dimensions [mm]				
d mm	d inch		D	B	s	e1	C
12		SES201	40	28,6	6	0,5	12
15		SES202	40	28,6	6	0,5	12
17		SES203	40	28,6	6	0,5	12
20		SES204	47	31	7	0,5	14
	3/4	SES204-12	47	31	7	0,5	14
25		SES205	52	31	7,5	0,5	15
	1	SES205-16	52	31	7,5	0,5	15
30		SES206	62	35,7	8	0,5	16
	1 3/16	SES206-19	62	35,7	8	0,5	16
	1 1/4	SES206-20	62	35,7	8	0,5	16
35		SES207	72	38,9	8,5	1	17
	1 3/8	SES207-22	72	38,9	8,5	1	17
	1 7/16	SES207-23	72	38,9	8,5	1	17
40		SES208	80	43,7	9	1	18
	1 1/2	SES208-24	80	43,7	9	1	18
45		SES209	85	43,7	9,5	1	19
	1 3/4	SES209-28	85	43,7	9,5	1	19
50		SES210	90	43,7	10	1	20
	1 15/16	SES210-31	90	43,7	10	1	20
	2	SES211-32	100	48,4	10,5	1	21
55		SES211	100	48,4	10,5	1	21
60		SES212	110	53,1	11	1	22

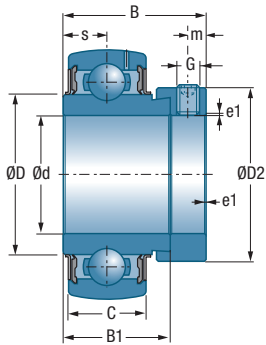

Main dimensions [mm]

Main dimensions [mm]				Bearing load rating (N)		Total weight		Shaft diameter	
G	m	B1	D2	C _r dyn.	C _{0r} stat.	kg	d inch	d mm	
M6x1	5	19,1	28,6	7,80	4,50	0,14		12	
M6x1	5	19,1	28,6	7,80	4,50	0,12		15	
M6x1	5	19,1	28,6	7,80	4,50	0,11		17	
M6x1	5	21,5	33,3	10,10	6,80	0,17		20	
M6x1	5	21,5	33,3	10,10	6,80	0,17	3/4		
M6x1	5	21,5	38,1	11,00	8,00	0,20		25	
M6x1	5	21,5	38,1	11,00	8,00	0,20	1		
M8x1	6	23,8	44,5	15,30	11,50	0,32		30	
M8x1	6	23,8	44,5	15,30	11,50	0,32	1 3/16		
M8x1	6	23,8	44,5	15,30	11,50	0,32	1 1/4		
M8x1	6,5	25,4	55,6	20,10	15,60	0,51		35	
M8x1	6,5	25,4	55,6	20,10	15,60	0,51	1 3/8		
M8x1	6,5	25,4	55,6	20,10	15,60	0,51	1 7/16		
M8x1	6,5	30,2	60,3	22,80	18,20	0,64		40	
M8x1	6,5	30,2	60,3	22,80	18,20	0,64	1 1/2		
M8x1	6,5	30,2	63,5	25,70	20,80	0,67		45	
M8x1	6,5	30,2	63,5	25,70	20,80	0,67	1 3/4		
M8x1	6,5	30,2	69,9	27,50	23,70	0,75		50	
M8x1	6,5	30,2	69,9	27,50	23,70	0,75	1 15/16		
M10x1,25	8	32,5	76,2	34,00	25,50	1,03	2		
M10x1,25	8	32,5	76,2	34,00	25,50	1,03		55	
M10x1,25	8	37,1	84,2	41,00	31,50	1,34		60	



→ GNP (metric)

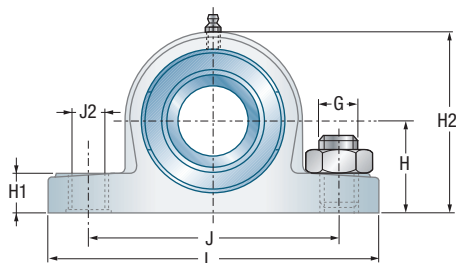

Unit		Main dimensions [mm]							
Housing complete	Bearings	Bore d	L	H	H1	H2	J	J1	J2
GNP20	MUC 204 FD	20	127,0	33,30	14,2	65,0	95,0	11,0	14,0
GNP25	MUC 205 FD	25	140,0	36,50	14,5	71,0	105,0	11,0	14,0
GNP30	MUC 206 FD	30	162,0	42,90	17,8	83,0	119,0	14,0	18,0
GNP35	MUC 207 FD	35	167,0	47,60	18,0	94,0	127,0	14,0	18,0
GNP40	MUC 208 FD	40	184,0	49,20	19,5	98,0	137,0	14,0	18,0

Note: upon request, these bearings can be equipped with bearing inserts in imperial dimensions

→ GSF (metric)

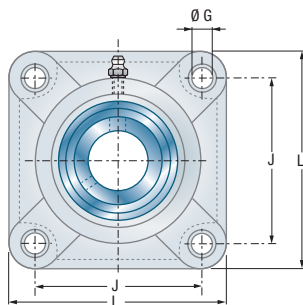

Unit		Main dimensions [mm]						
Housing complete	Bearings	Bore d	L	J	G	A	A1	A4
GSF20	MUC 204 FD	20	86	63,5	11	27,8	36,3	13,4
GSF25	MUC 205 FD	25	95	70,0	11	28,0	36,7	14,3
GSF30	MUC 206 FD	30	107	83,0	11	31,5	41,4	14,3
GSF35	MUC 207 FD	35	118	92,0	13	34,8	49,9	15,5
GSF40	MUC 208 FD	40	130	102,0	14	37,5	53,2	17,0

Note: upon request, these bearings can be equipped with bearing inserts in imperial dimensions

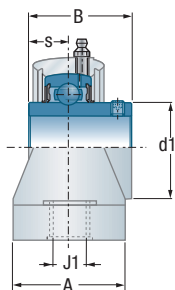

Main dimensions [mm]					Load rating C_{0r} stat.	Max. speed limit rpm	Total weight kg	Unit	
G	A	B	s	d1				Bearings	Housing complete
10	38,0	31,00	12,70	29,00	1,70	7 400	0,30	MUC 204 FD	GNP20
10	38,0	34,10	14,30	34,00	2,00	6 200	0,35	MUC 205 FD	GNP25
12	46,0	38,10	15,90	40,50	2,50	5 300	0,55	MUC 206 FD	GNP30
12	48,0	42,90	17,50	48,00	3,00	4 500	0,78	MUC 207 FD	GNP35
12	54,0	49,20	19,00	53,00	3,00	4 000	0,98	MUC 208 FD	GNP40

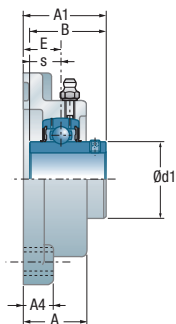

Main dimensions [mm]				Load rating C_{0r} stat.	Max. speed limit rpm	Total weight kg	Unit	
$E_{\pm IT14}$	B	s	d1				Bearings	Housing complete
18,0	31,0	12,7	29,0	1,60	7 400	0,30	MUC 204 FD	GSF20
17,0	34,0	14,3	34,0	1,70	6 200	0,36	MUC 205 FD	GSF25
19,2	38,1	15,9	40,5	2,30	5 300	0,51	MUC 206 FD	GSF30
21,5	42,9	17,5	48,0	3,10	4 500	0,75	MUC 207 FD	GSF35
23,0	49,2	19,0	53,0	3,10	4 000	0,98	MUC 208 FD	GSF40

→ **GSFT (metric)**

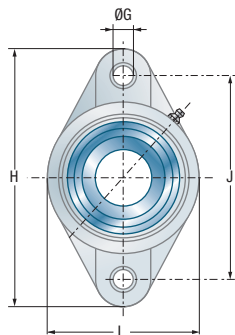

Unit		Main dimensions [mm]						
Housing complete	Bearings	Bore d	L	H	J	G	A	A1
GSFT20	MUC 204 FD	20	64,8	113,0	90,0	11	26,50	33,70
GSFT25	MUC 205 FD	25	70,0	130,0	99,0	11	29,70	36,70
GSFT30	MUC 206 FD	30	80,0	148,0	117,0	11	30,50	41,20
GSFT35	MUC 207 FD	35	90,0	163,0	130,0	13	32,80	43,40
GSFT40	MUC 208 FD	40	100,0	175,0	144,0	14	37,50	51,70

Note: upon request, these bearings can be equipped with bearing inserts in imperial dimensions

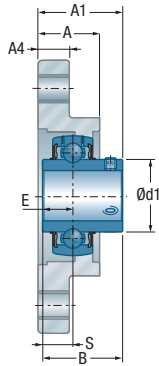

Main dimensions [mm]					Load rating C_{Or} stat.	Max. speed limit rpm	Total weight kg	Unit	
A4	E $\pm IT14$	B	s	d1				Bearings	Housing complete
11,40	15,4	31,00	12,70	29,00	2,20	7 400	0,25	MUC 204 FD	GSFT20
13,50	17,0	34,00	14,30	34,00	2,20	6 200	0,30	MUC 205 FD	GSFT25
13,30	19,0	38,10	15,90	40,50	2,90	5 300	0,45	MUC 206 FD	GSFT30
16,10	18,0	42,90	17,50	48,00	3,20	4 500	0,67	MUC 207 FD	GSFT35
20,00	21,5	49,20	19,00	53,00	3,20	4 000	0,88	MUC 208 FD	GSFT40



Stainless steel bearing inserts

→ MUC (inch)

Unit	Main dimensions [mm]											
	Bore d		D		C		B1		s		D1	
Bearings	inch	mm	inch	mm	inch	mm	inch	mm	inch	mm	inch	mm
MUC 202-10 FD	5/8	15,875	1,850	47	0,669	17	1,220	31,00	0,500	12,7	1,142	29,0
MUC 204-12 FD	3/4	19,050	1,850	47	0,669	17	1,220	31,00	0,500	12,7	1,142	29,0
MUC 205-16 FD	1	25,400	2,047	52	0,669	17	1,339	34,10	0,563	14,3	1,339	34,0
MUC 206-18 FD	1-1/8	28,575	2,441	62	0,748	19	1,500	38,10	0,626	15,9	1,594	40,5
MUC 206-19 FD	1-3/16	30,162	2,441	62	0,748	19	1,500	38,10	0,626	15,9	1,594	40,5
MUC 206-20 FD	1-1/4	31,750	2,441	62	0,748	19	1,500	38,10	0,626	15,9	1,594	40,5
MUC 207-20 FD	1-1/4	31,750	2,835	72	0,787	20	1,689	42,90	0,689	17,5	1,890	48,0
MUC 207-22 FD	1-3/8	34,925	2,835	72	0,787	20	1,689	42,90	0,689	17,5	1,890	48,0
MUC 207-23 FD	1-7/16	36,512	2,835	72	0,787	20	1,689	42,90	0,689	17,5	1,890	48,0
MUC 208-24 FD	1-1/2	38,100	3,150	80	0,827	21	1,937	49,20	0,748	19,0	2,087	53,0

→ MUC (metric)

Unit	Main dimensions [mm]					
	Bore d	D	C	B1	s	D1
MUC 204 FD	20	47	17	31,00	12,70	29,00
MUC 205 FD	25	52	17	34,10	14,30	34,00
MUC 206 FD	30	62	19	38,10	15,90	40,50
MUC 207 FD	35	72	20	42,90	17,50	48,00
MUC 208 FD	40	80	21	49,20	19,00	53,00

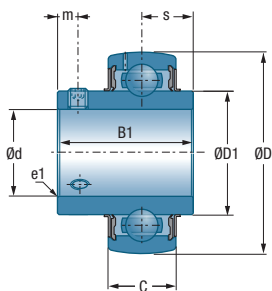

Main dimensions [mm]				Load rating				Max. speed limit	Total weight		Unit
m	e1			C_r (dyn.)	C_{Or} (stat.)		rpm	lbs	kg	Bearings	
inch	mm	inch	mm	lbf	[kN]	lbf	[kN]				
0,177	4,5	0,039	1,0	2 450	10,90	1 190	5,30	7 400	0,400	0,181	MUC 202-10 FD
0,177	4,5	0,059	1,5	2 450	10,90	1 190	5,30	7 400	0,350	0,159	MUC 204-12 FD
0,197	5,0	0,059	1,5	2 680	11,90	1 420	6,30	6 200	0,400	0,181	MUC 205-16 FD
0,197	5,0	0,059	1,5	3 750	16,70	2 030	9,00	5 300	0,680	0,308	MUC 206-18 FD
0,197	5,0	0,059	1,5	3 750	16,70	2 030	9,00	5 300	0,680	0,308	MUC 206-19 FD
0,197	5,0	0,059	1,5	3 750	16,70	2 030	9,00	5 300	0,680	0,308	MUC 206-20 FD
0,236	6,0	0,079	2,0	4 950	22,00	2 770	12,30	4 500	1,06	0,480	MUC 207-20 FD
0,236	6,0	0,079	2,0	4 950	22,00	2 770	12,30	4 500	1,06	0,480	MUC 207-22 FD
0,236	6,0	0,079	2,0	4 950	22,00	2 770	12,30	4 500	1,06	0,480	MUC 207-23 FD
0,315	6,0	0,079	2,0	5 600	24,90	3 210	14,30	4 000	1,37	0,621	MUC 208-24 FD

Main dimensions [mm]		Load rating x 1000 newtons		Max. speed limit	Total weight	Unit
m	e1	C_r dyn.	C_{Or} stat.	rpm	kg	Bearings
4,50	1,5	10,90	5,30	7 400	0,16	MUC 204 FD
5,00	1,5	11,90	6,30	6 200	0,19	MUC 205 FD
5,00	1,5	16,70	9,00	5 300	0,31	MUC 206 FD
6,00	2,0	22,00	12,30	4 500	0,48	MUC 207 FD
8,00	2,0	24,90	14,30	4 000	0,62	MUC 208 FD



→ Thermoplastic self-aligning bearing caps

CF.. – CV..

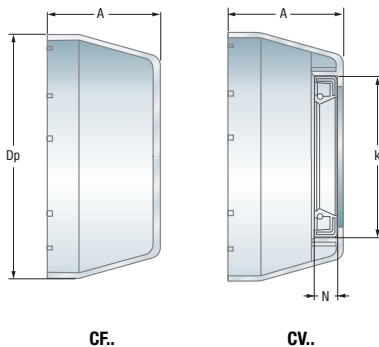

Caps	Unit		Bore diameter		Dimensions in mm				
	metrics	Bearings inch	mm	d inch	Dp	A	N	k	
CV 15	–	MUC 202-10 FD	15	5/8	50,1	23	7	32	
CF 20 CV 20	MUC 204 FD	MUC 204-12 FD	20	3/4	50,1	23	7	32	
CF 25 CV 25	MUC 205 FD	MUC 205-16 FD	25	1	55	25	7	37	
CF 30 CV 30	MUC 206 FD	MUC 206-18 FD MUC 206-20 FD	MUC 206-19 FD	30	1 ^{1/8} 1 ^{3/16} 1 ^{1/4}	64	30	7	42
CF 35 CV 35	MUC 207 FD	MUC 207-20 FD MUC 207-23 FD	MUC 207-22 FD	35	1 ^{1/4} 1 ^{3/8} 1 ^{7/16}	74,5	32	7	47
CF 40 CV 40	MUC 208 FD	MUC 208-24 FD		40	1 ^{1/2}	84	37	7	52

Split pillow blocks

■ Definition and capabilities	644
■ Series	645
■ Variants	645
■ Design criteria: loads and torques	646
■ Installation/Assembly criteria: seal selection	647
■ Characteristics	648
<i>Pillow block housing for bearings with adapter sleeve mounting</i>	648
<i>Pillow block housing for bearings with cylindrical bore</i>	660



Definition and capabilities

■ The SNC pillow block housing is a technological advancement of our previous SNB and SNU series.

The major abutment dimensions of the SNC series correspond to the specifications in ISO 113/II : 1994 and DIN 736 :1984 to DIN 739 :1984.

The bearing units are based on our split housing. By default, these are made of grey cast iron in compliance with DIN EN 1961 and are available in different sizes. On request, for particularly high loads, housings can also be produced from other materials, such as ductile iron, in the same dimensions. Each individual housing can hold bearings of different diameters and widths. They are primarily self-aligning roller bearings.

However, the crucial factor is the type of application. For example, if high speeds are required, self-aligning ball bearings can be used. Self-aligning roller bearings are particularly well suited for high axial and radial forces.

Combined with the various sealing elements, this results in a variety of possible designs, which makes up SNR's standard range. The shaft diameters are between 20 and 160 mm (special dimensions on request). The bearings with tapered bore inner are attached to the shaft using an adapter sleeve. By contrast, bearings with a cylindrical inner ring lie directly on the shaft.

There are a wide variety of sealing options for the housing due to the large number of practical applications. The most important factors are the speeds and the external influences that act on the unit.

■ The SNR standard range includes:

- Double lip seal
- Felt strip seal with retainer
- V-ring seal with contact washer
- Labyrinth ring seal
- Taconite seal

All SNC units are designed for both through shafts and for shaft ends.

A cover plate is available for these versions, which is inserted in the sealing groove in place of the seal.

Series

■ 500 series

Bearing housing for rolling bearings with tapered bore from 1200K to 2200K, 22200K and 23200K series
Shaft diameter : 20 - 140 mm

■ 600 series

Bearing housing for rolling bearings with tapered bore from 1300 K, 2300K, 21300K and 22300K series
Shaft diameter: 20 - 90 mm

■ 200 series

Bearing housing for rolling bearings with cylindrical bore from 1200, 2200, 22200 and 23200 series
Shaft diameter: 25 - 160 mm

■ 300 series

Bearing housing for rolling bearings with cylindrical bore from 1300, 2300, 21300 and 22300 series
Shaft diameter: 25 - 100 mm

Variants

■ Fixed bearing version

All SNC housings can be used as fixed bearings by using stabilizing rings which must be ordered separately. Two rings are required per housing. The corresponding sizes can be found in the dimension tables.

■ Seal versions

- ▶ **SC..DS** Double lip seal
- ▶ **SC..FS** Felt strip seal
- ▶ **SC..SV** V-ring seal
- ▶ **SC..LA** Labyrinth seal
- ▶ **SC..TA** Taconite seal
- ▶ **V..A** V-ring (A version) in addition to SC...FS
- ▶ **SC..EC** Cover plate

Example designation:

SC518DS

A cover (SC...EC) is available for these versions. This is inserted in the groove between the upper and lower sections in place of the second seal.

■ Complete systems

SNR offers its customers the opportunity to jointly develop and produce application-specific complete systems. These bearing systems can be integrated directly into the relevant applications. The cost reduction, particularly for series production, justifies the purchase of finished system solutions. Logistical processes are simplified and installation times cut. In addition, the risk of mounting errors is avoided.

Our name is your guarantee of correct mounting and optimum quality of the products used.
Benefit from our services !

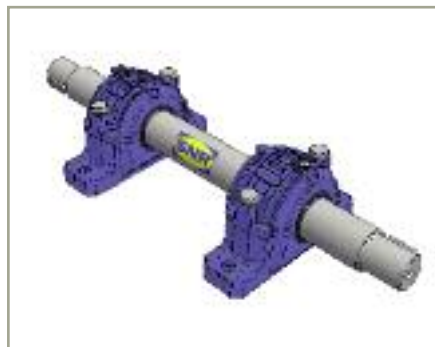

Design criteria: loads and torques



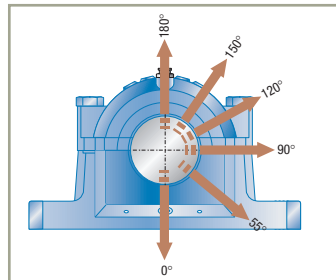







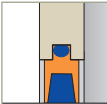
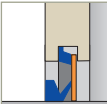
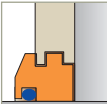
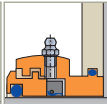

























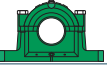



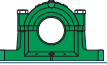









The table below contains information about the breaking loads of SNC bearing housing and the maximum loading capacity of the connecting bolts between the upper and the lower section and the foot bolts. The load directions and the safety factor selected for the appropriate operating conditions can be used to determine the permissible loads. In general, a safety factor of 6 is used for engineering calculations. The specified values are intended solely as reference values.



Housing size SNC		Housing breaking loads in load direction						Connecting bolts (upper/lower) Property class 8.8	Max. load capacity for both bolts in load direction			Recommended tightening torque Nm	Foot bolts' Property class 8.8	Max. tightening torque Nm
		0°	55°	90°	120°	150°	180°		120°	150°	180°			
205	505	180	160	95	70	60	80	M10x40	60	35	30	65	M12	87
206	305 506 605	200	170	100	80	67	85	M10x40	60	35	30	65	M12	87
207	306 507 606	224	190	121	85	80	95	M10x45	60	35	30	65	M12	87
208	307 508 607	265	220	132	95	85	115	M12x50	80	45	40	65	M12	87
209	509	280	235	140	100	90	120	M12x55	80	45	40	65	M12	87
210	308 510 608	315	265	160	121	110	140	M12x55	80	45	40	65	M12	87
211	309 511 609	355	280	170	125	118	145	M16x60	180	100	90	150	M16	210
212	310 512 610	355	300	180	132	125	160	M16x60	180	100	90	150	M16	210
213	311 513 611	400	345	210	150	132	170	M16x70	180	100	90	150	M16	210
214		450	360	220	160	145	185	M16x70	180	100	90	150	M16	210
215	312 515 612	475	411	250	185	160	215	M16x70	180	100	90	150	M16	210
216	313 516 613	500	430	265	190	175	220	M16x80	180	100	90	290	M20	410
217	314 517	560	480	290	205	191	250	M16x80	180	100	90	290	M20	410
218	315 518 615	670	550	340	250	220	285	M20x90	260	150	130	290	M20	410
219	316 519 616	710	580	355	265	230	300	M20x100	260	150	130	290	M20	410
220	317 520 617	750	630	375	280	250	320	M24x100	360	210	180	500	M24	710
	318 618	800	670	400	315	280	340	M24x110	360	210	180	500	M24	710
222	319 522 619	950	800	450	355	320	400	M24x130	360	210	180	500	M24	710
224	320 524 620	950	800	475	355	320	420	M24x130	360	210	180	500	M24	710
226	526	1060	900	540	410	360	450	M24x130	360	210	180	500	M24	710
228	528	1250	1060	630	475	430	530	M24x140	360	210	180	1005	M30	1430
230	530	1400	1200	730	540	480	600	M24x150	360	210	180	1005	M30	1430
232	532	1700	1450	860	640	570	730	M30x160	730	430	360	1005	M30	1430

1. ISO 4014 (DIN EN 24014)

Installation/assembly criteria: seal selection

					
	SC..DS	SC..FS	SC..SV	SC..LA	SC..TA
Structural properties	Double lip seal	Felt strip seal	V-ring seal	Labyrinth seal	Taconite seal
Operating temperature (°C)	-40...+100	-40...+100	-40...+100	-40...+200	-40...+100
Circumferential speed (m/s)	< 8	< 15	< 7 ³	> 15	< 10 ⁴
Possible misalignment (Degrees)	0,5...1	< 0,5	1...1,5	< 0,3	< 0,5
Relubrication					
Low friction					
Suitable for floating bearings					
Vertical installation					
Sealing behaviour for:					
Splash water / moisture					
Ultra fine particles					
Fine particles					
Large particles					
Sharp-edge particles					
UV resistance					

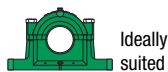

Ideally suited



Limited suitability



Suitable



Unsuitable

- 1) During running-in phase up to approx. 5m/s
- 2) If V-ring is fitted inside on underside
- 3) Without additional supporting ring (axially secured: 7-12 m/s); axially and radially secured >12 m/s)
- 4) Depending on shaft diameter

Pillow block housing for bearings with adapter sleeve mounting

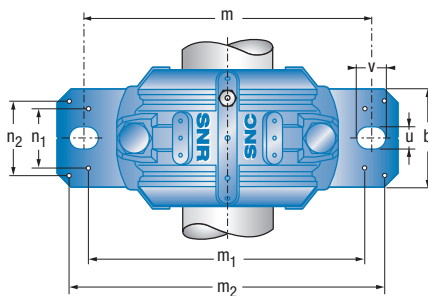
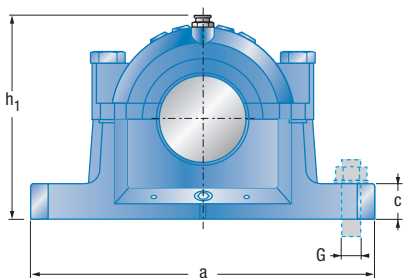

d	Type	Housing dimensions															Weight ¹ ≈ [kg]		
		D	a	b	c	g	h	l	m	G	u	v	h ₁	m ₁	n ₂	m ₂		n ₁	n ₃
20	SNC505	52	165	46	19	25	40	67	130	M12	15	20	74	116	32	152	28	36	1.6
	SNC605	62	185	52	22	32	50	77	150	M12	15	20	89	130	38	172	25	44	2.3
25	SNC506	62	185	52	22	32	50	77	150	M12	15	20	89	130	38	172	25	44	2.3
	SNC606	72	185	52	22	34	50	82	150	M12	15	20	93	135	38	172	25	46	2.4
30	SNC507	72	185	52	22	34	50	82	150	M12	15	20	93	135	38	172	25	46	2.4
	SNC607	80	205	60	25	39	60	85	170	M12	15	20	107	160	44	188	34	50	3.2

1. Pillow block housing

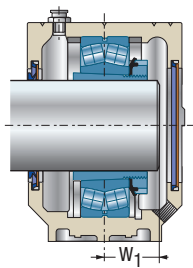

V-ring seal
SC..SV + Cover
SC..EC

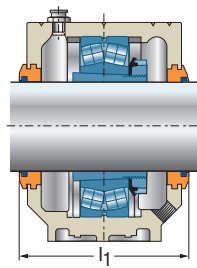

Labyrinth seal
SC..LA

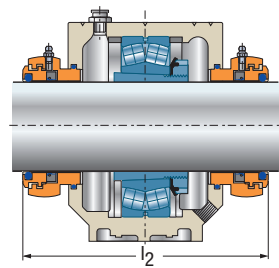

Tacornite seal
SC..TA

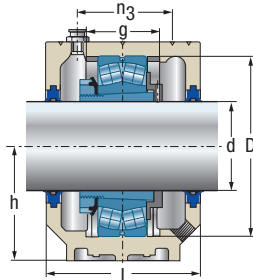

Double lip seal
SC..DS + Regulation disc
RDC

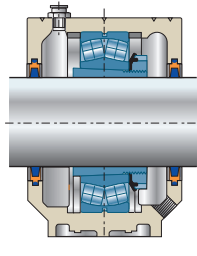

Felt strip seal
SC..FS

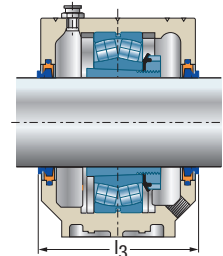

Felt strip seal
SC..FS + V-ring seal
V..A

Housing	Seal ²	V-ring seal ³	Cover	w ₁	l ₁	l ₂	l ₃	Regulation disc	Bearing	Adapter sleeve	Locating ring 2 x per housing
SNC505	SC505DS	V20A	SC505EC	18.0	79	134	85	RDC505	1205K	H205	FR52x5
	SC505FS			19.5					2205K	H305	FR52x3.5
	SC505SV			19.5					22205K	H305	FR52x3.5
	SC505LA										
	SC505TA										
SNC506-605	SC605DS	V20A	SC506-605EC	19.0	89	144	95	RDC605	1305K	H305	FR62x7.5
	SC605FS			22.5					2305K	H2305	FR62x4
	SC605SV			19.0					21305K	H305	FR62x7.5
	SC605LA										
	SC605TA										
SNC506-605	SC506DS	V25A	SC506-605EC	18.5	89	144	95	RDC506	1206K	H206	FR62x8
	SC506FS			20.5					2206K	H306	FR62x6
	SC506SV			20.5					22206K	H306	FR62x6
	SC506LA										
	SC506TA										
SNC507-606	SC606DS	V25A	SC507-606EC	20.0	94	148	100	RDC606	1306K	H306	FR72x7.5
	SC606FS			24.0					2306K	H2306	FR72x3.5
	SC606SV			20.0					21306K	H306	FR72x7.5
	SC606LA										
	SC606TA										
SNC507-606	SC507DS	V30A	SC507-606EC	20.0	94	148	100	RDC507	1207K	H207	FR72x8.5
	SC507FS			23.0					2207K	H307	FR72x5.5
	SC507SV			23.5					22207K	H307	FR72x5.5
	SC507LA										
	SC507TA										
SNC508-607	SC607DS	V30A	SC508-607EC	22.0	97	151	103	RDC607	1307K	H307	FR80x9
	SC607FS			27.0					2307K	H2307	FR80x4
	SC607SV			23.0					21307K	H307	FR80x8
	SC607LA										
	SC607TA										

2. Seals must be ordered for each side of the housing.

3. Optional V-ring available for felt strip seal (FS).



Pillow block housing for bearings with adapter sleeve mounting *(continued)*

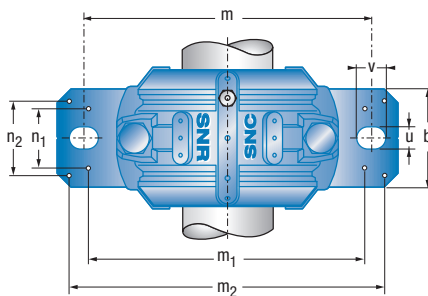
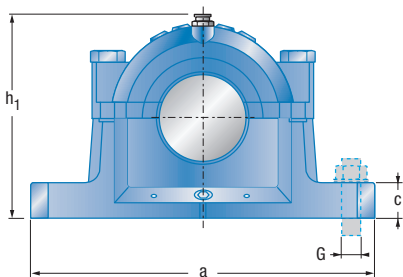

d	Type	Housing dimensions															Weight ¹		
		D	a	b	c	g	h	l	m	G	u	v	h ₁	m ₁	n ₂	m ₂	n ₁	n ₃	≈ [kg]
35	SNC508	80	205	60	25	39	60	85	170	M12	15	20	107	160	44	188	34	50	3.2
	SNC608	90	205	60	25	41	60	90	170	M12	15	20	113	160	44	188	34	53	3.4
40	SNC509	85	205	60	25	30	60	85	170	M12	15	20	110	160	44	188	34	44	3.2
	SNC609	100	255	70	28	44	70	95	210	M16	18	24	127	200	49	234	40	56	5.1
45	SNC510	90	205	60	25	41	60	90	170	M12	15	20	113	160	44	188	34	53	3.4
	SNC610	110	255	70	30	48	70	105	210	M16	18	24	133	200	54	234	40	64	5.4

1. Pillow block housing

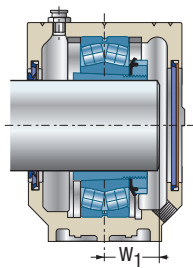

V-ring seal
SC..SV + Cover
SC..EC

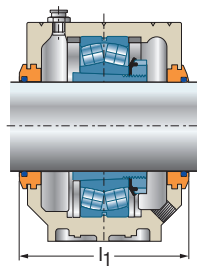

Labyrinth seal
SC..LA

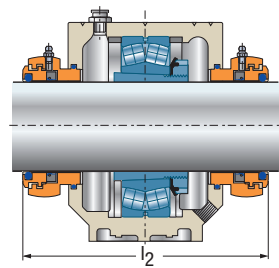

Tacomite seal
SC..TA

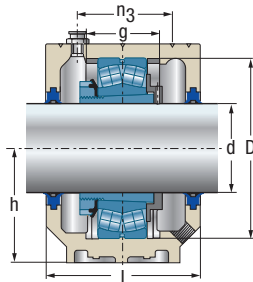

Double lip seal
SC..DS + Regulation disc
RDC

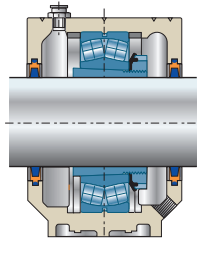

Felt strip seal
SC..FS

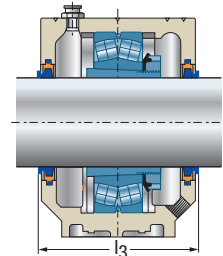

Felt strip seal
SC..FS + V-ring seal
V..A

Housing	Seal ²	V-ring seal ³	Cover	w ₁	l ₁	l ₂	l ₃	Regulation disc	Bearing	Adapter sleeve	Locating ring 2 x per housing
SNC508-607	SC508DS	V35A	SC508-607EC	21.5	97	151	103	RDC508	1208K	H208	FR80x10.5
	SC508FS			24.0					2208K	H308	FR80x8
	SC508SV			24.0					22208K	H308	FR80x8
	SC508LA										
	SC508TA										
SNC510-608	SC608DS	V35A	SC510-608EC	24.0	102	154	108	RDC608	1308K	H308	FR90x9
	SC608FS			29.0					2308K	H2308	FR90x4
	SC608SV			24.0					21308K	H308	FR90x9
	SC608LA			29.0					22308K	H2308	FR90x4
	SC608TA										
SNC509	SC509DS	V40A	SC509EC	23.0	97	149	107	RDC509	1209K	H209	FR85x5.5
	SC509FS			25.0					2209K	H309	FR85x3.5
	SC509SV			25.0					22209K	H309	FR85x3.5
	SC509LA										
	SC509TA										
SNC511-609	SC609DS	V40A	SC511-609EC	26.0	107	158	117	RDC609	1309K	H309	FR100x9.5
	SC609FS			31.5					2309K	H2309	FR100x4
	SC609SV			26.0					21309K	H309	FR100x9.5
	SC609LA			31.5					22309K	H2309	FR100x4
	SC609TA										
SNC510-608	SC510DS	V45A	SC510-608EC	24.5	102	154	112	RDC510	1210K	H210	FR90x10.5
	SC510FS			26.0					2210K	H310	FR90x9
	SC510SV			26.0					22210K	H310	FR90x9
	SC510LA										
	SC510TA										
SNC512-610	SC610DS	V45A	SC512-610EC	28.0	117	168	127	RDC610	1310K	H310	FR110x10.5
	SC610FS			34.5					2310K	H2310	FR110x4
	SC610SV			28.0					21310K	H310	FR110x10.5
	SC610LA			34.5					22310K	H2310	FR110x4
	SC610TA										

2. Seals must be ordered for each side of the housing.

3. Optional V-ring available for felt strip seal (FS).



Pillow block housing for bearings with adapter sleeve mounting *(continued)*

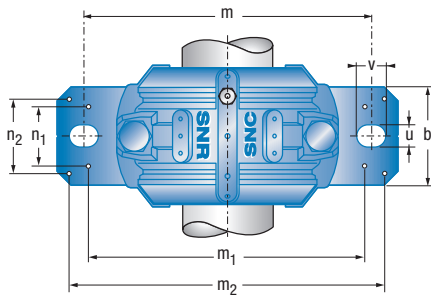
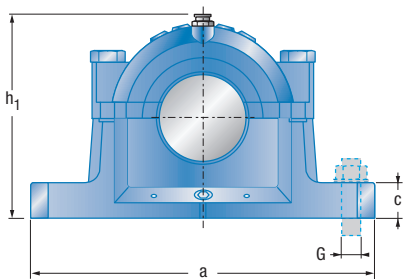

d	Type	Housing dimensions															Weight ¹ ≈ [kg]		
		D	a	b	c	g	h	l	m	G	u	v	h ₁	m ₁	n ₂	m ₂		n ₁	n ₃
50	SNC511	100	255	70	28	44	70	95	210	M16	18	24	127	200	49	234	40	56	5.1
	SNC611	120	275	80	30	51	80	110	230	M16	18	24	148	220	58	252	48	63	7.0
55	SNC512	110	255	70	30	48	70	105	210	M16	18	24	133	200	54	234	40	64	5.4
	SNC612	130	280	80	30	56	80	115	230	M16	18	24	155	220	58	257	48	72	7.3
60	SNC513	120	275	80	30	51	80	110	230	M16	18	24	148	220	58	252	48	63	7.0
	SNC613	140	315	90	32	58	95	120	260	M20	22	28	175	252	66	288	52	72	10.4

1. Pillow block housing

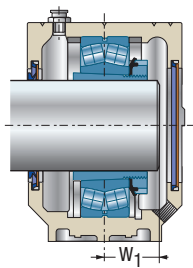

V-ring seal
SC..SV + Cover
SC..EC

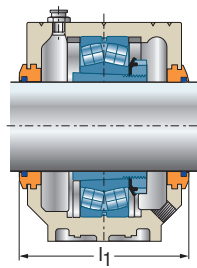

Labyrinth seal
SC..LA

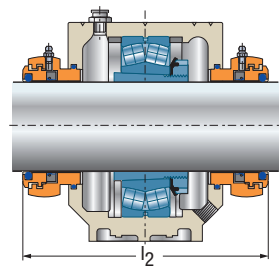

Taconite seal
SC..TA

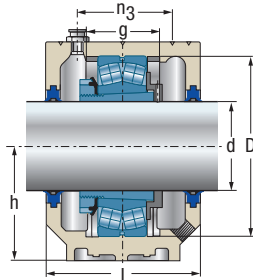

Double lip seal
SC..DS + Regulation disc
RDC

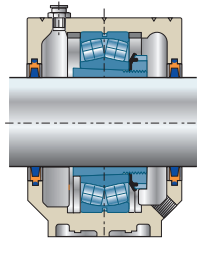

Felt strip seal
SC..FS

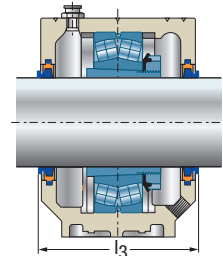

Felt strip seal
SC..FS + V-ring seal
V..A

Housing	Seal ²	V-ring seal ³	Cover	w ₁	l ₁	l ₂	l ₃	Regulation disc	Bearing	Adapter sleeve	Locating ring 2 x per housing
SNC511-609	SC511DS	V50A	SC511-609EC	25.5	107	158	117	RDC511	1211K	H211	FR100x11.5
	SC511FS			27.5					2211K	H311	FR100x9.5
	SC511SV			27.5					22211K	H311	FR100x9.5
	SC511LA										
	SC511TA										
SNC513-611	SC611DS	V50A	SC513-611EC	29.5	122	172	132	RDC611	1311K	H311	FR120x11
	SC611FS			36.5					2311K	H2311	FR120x4
	SC611SV			29.5					21311K	H311	FR120x11
	SC611LA			36.5					22311K	H2311	FR120x4
	SC611TA										
SNC512-610	SC512DS	V55A	SC512-610EC	26.5	117	168	127	RDC512	1212K	H212	FR110x13
	SC512FS			29.5					2212K	H312	FR110x10
	SC512SV			29.5					22212K	H312	FR110x10
	SC512LA										
	SC512TA										
SNC515-612	SC612DS	V55A	SC515-612EC	31.0	127	181	137	RDC612	1312K	H312	FR130x12.5
	SC612FS			38.5					2312K	H2312	FR130x5
	SC612SV			31.0					21312K	H312	FR130x12.5
	SC612LA			38.5					22312K	H2312	FR130x5
	SC612TA										
SNC513-611	SC513DS	V60A	SC513-611EC	28.0	122	172	132	RDC513	1213K	H213	FR120x14
	SC513FS			32.0					2213K	H313	FR120x10
	SC513SV			32.0					22213K	H313	FR120x10
	SC513LA										
	SC513TA										
SNC516-613	SC613DS	V60A	SC516-613EC	33.0	135	190	142	RDC613	1313K	H313	FR140x12.5
	SC613FS			40.5					2313K	H2313	FR140x5
	SC613SV			33.0					21313K	H313	FR140x12.5
	SC613LA			40.5					22313K	H2313	FR140x5
	SC613TA										

2. Seals must be ordered for each side of the housing.

3. Optional V-ring available for felt strip seal (FS).



Pillow block housing for bearings with adapter sleeve mounting *(continued)*

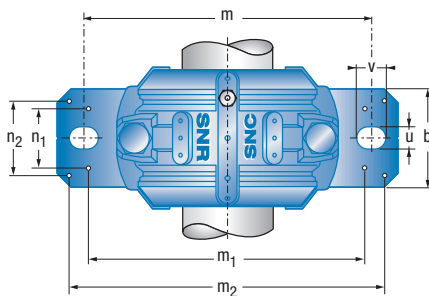
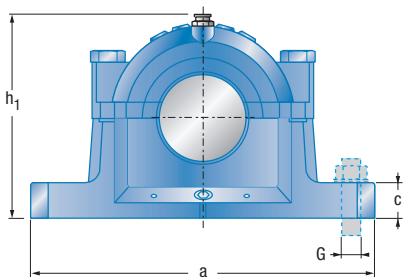

d	Type	Housing dimensions															Weight ¹ ≈ [kg]		
		D	a	b	c	g	h	l	m	G	u	v	h ₁	m ₁	n ₂	m ₂		n ₁	n ₃
65	SNC515	130	280	80	30	56	80	115	230	M16	18	24	155	220	58	257	48	72	7.3
	SNC615	160	345	100	35	65	100	140	290	M20	22	28	192	280	74	319	58	80	13.5
70	SNC516	140	315	90	32	58	95	120	260	M20	22	28	175	252	66	288	52	72	10.4
	SNC616	170	345	100	35	68	112	145	290	M20	22	28	212	280	70	317	58	88	15.6
75	SNC517	150	320	90	32	61	95	125	260	M20	22	28	183	252	66	292	52	76	10.2
	SNC617	180	380	110	40	70	112	160	320	M24	26	32	215	300	78	348	66	104	18.4

1. Pillow block housing

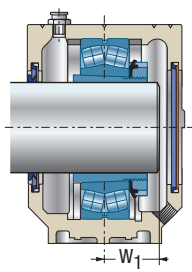

V-ring seal
SC..SV + Cover
SC..EC

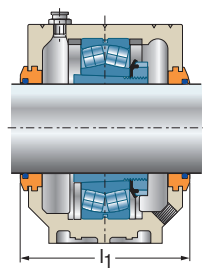

Labyrinth seal
SC..LA

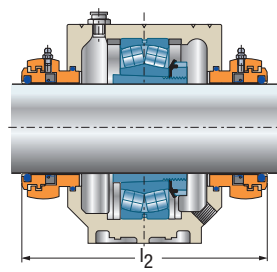

Tacornite seal
SC..TA

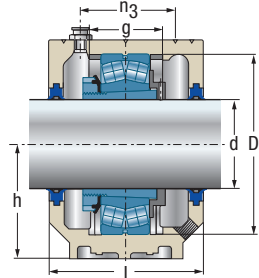

Double lip seal
SC..DS + Regulation disc
RDC

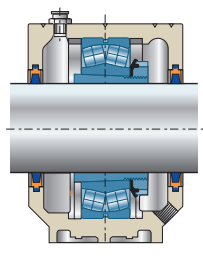

Felt strip seal
SC..FS

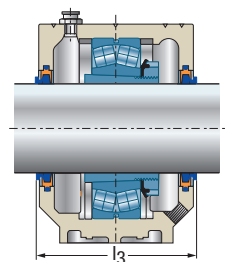

Felt strip seal
SC..FS + V-ring seal
V..A

Housing	Seal ²	V-ring seal ³	Cover	w ₁	l ₁	l ₂	l ₃	Regulation disc	Bearing	Adapter sleeve	Locating ring 2 x per housing
SNC515-612	SC515DS	V65A	SC515-612EC	30.0	127	181	137	RDC515	1215K	H215	FR130x15.5
	SC515FS			33.0					2215K	H315	FR130x12.5
	SC515SV			33.0					22215K	H315	FR130x12.5
	SC515LA										
	SC515TA										
SNC518-615	SC615DS	V65A	SC518-615EC	36.0	155	216	162	RDC615	1315K	H315	FR160x14
	SC615FS			45.0					2315K	H2315	FR160x5
	SC615SV			36.0					21315K	H315	FR160x14
	SC615LA			45.0					22315K	H2315	FR160x5
	SC615TA										
SNC516-613	SC516DS	V70A	SC516-613EC	32.5	135	190	147	RDC516	1216K	H216	FR140x16
	SC516FS			36.0					2216K	H316	FR140x12.5
	SC516SV			36.0					22216K	H316	FR140x12.5
	SC516LA										
	SC516TA										
SNC519-616	SC616DS	V70A	SC519-616EC	39.0	159	212	172	RDC616	1316K	H316	FR170x14.5
	SC616FS			48.5					2316K	H2316	FR170x5
	SC616SV			39.0					21316K	H316	FR170x14.5
	SC616LA			48.5					22316K	H2316	FR170x5
	SC616TA										
SNC517	SC517DS	V75A	SC517EC	34.5	140	201	152	RDC517	1217K	H217	FR150x16.5
	SC517FS			38.5					2217K	H317	FR150x12.5
	SC517SV			38.5					22217K	H317	FR150x12.5
	SC517LA										
	SC517TA										
SNC520-617	SC617DS	V75A	SC520-617EC	41.0	174	227	187	RDC617	1317K	H317	FR180x14.5
	SC617FS			50.5					2317K	H2317	FR180x5
	SC617SV			41.0					21317K	H317	FR180x14.5
	SC617LA			50.5					22317K	H2317	FR180x5
	SC617TA										

2. Seals must be ordered for each side of the housing.

3. Optional V-ring available for felt strip seal (FS).



Pillow block housing for bearings with adapter sleeve mounting (continued)

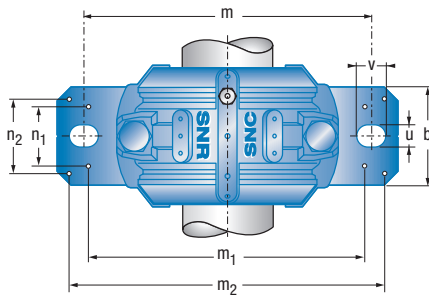
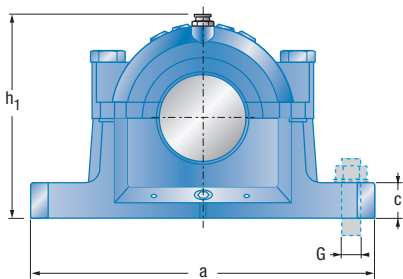

d	Type	Housing dimensions															Weight ¹		
		D	a	b	c	g	h	l	m	G	u	v	h_1	m_1	n_2	m_2	n_1	n_3	≈ [kg]
80	SNC518	160	345	100	35	65	100	140	290	M20	22	28	192	280	74	319	58	80	13.5
	SNC618	190	380	110	40	74	112	160	320	M24	26	32	220	300	78	348	66	104	18.5
85	SNC519	170	345	100	35	68	112	145	290	M20	22	28	212	280	70	317	58	88	15.6
	SNC619	200	410	120	45	80	125	175	350	M24	26	32	242	320	88	378	74	110	24.7
90	SNC520	180	380	110	40	70	112	160	320	M24	26	32	215	300	78	348	66	104	18.4
	SNC620	215	410	120	45	86	140	185	350	M24	26	32	271	330	88	378	74	122	30.0

1. Pillow block housing

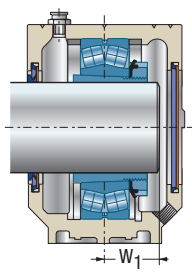

V-ring seal
SC..SV + Cover
SC..EC

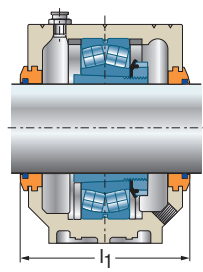

Labyrinth seal
SC..LA

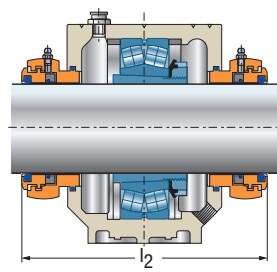

Tacornite seal
SC..TA

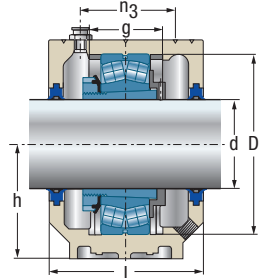

Double lip seal
SC..DS + Regulation disc
RDC

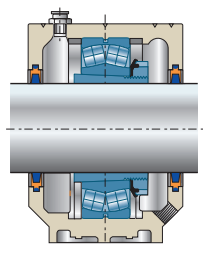

Felt strip seal
SC..FS

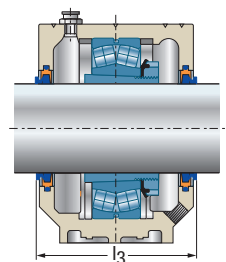

Felt strip seal
SC..FS + V-ring seal
V..A

Housing	Seal ²	V-ring seal ³	Cover	w ₁	l ₁	l ₂	l ₃	Regulation disc	Bearing	Adapter sleeve	Locating ring 2 x per housing
SNC518-615	SC518DS	V80A	SC518-615EC	35.5	155	216	167	RDC518	1218K	H218	FR160x17.5
	SC518FS			40.5					2218K	H318	FR160x12.5
	SC518SV			40.5					22218K	H318	FR160x12.5
	SC518LA			46.8					23218K	H2318	FR160x6.25
	SC518TA										
SNC318-618	SC618DS	V80A	SC318-618EC	42.0	172	227	187	RDC618	1318K	H318	FR190x15.5
	SC618FS			52.5					2318K	H2318	FR190x5
	SC618SV			42.0					21318K	H318	FR190x15.5
	SC618LA			52.5					22318K	H2318	FR190x5
	SC618TA										
SNC519-616	SC519DS	V85A	SC519-616EC	37.5	159	212	172	RDC519	1219K	H219	FR170x18
	SC519FS			43.0					2219K	H319	FR170x12.5
	SC519SV			43.0					22219K	H319	FR170x12.5
	SC519LA										
	SC519TA										
SNC522-619	SC619DS	V85A	SC522-619EC	44.0	189	242	202	RDC619	1319K	H319	FR200x17.5
	SC619FS			55.0					2319K	H2319	FR200x6.5
	SC619SV			44.0					21319K	H319	FR200x17.5
	SC619LA			55.0					22319K	H2319	FR200x6.5
	SC619TA										
SNC520-617	SC520DS	V90A	SC520-617EC	39.5	174	227	187	RDC520	1220K	H220	FR180x18
	SC520FS			45.5					2220K	H320	FR180x12
	SC520SV			45.5					23220K	H320	FR180x12
	SC520LA			52.7					23220K	H2320	FR180x4.85
	SC520TA										
SNC524-620	SC620DS	V90A	SC524-620EC	46.0	199	249	212	RDC620	1320K	H320	FR215x19.5
	SC620FS			59.0					2320K	H2320	FR215x6.5
	SC620SV			46.0					21320K	H320	FR215x19.5
	SC620LA			59.0					22320K	H2320	FR215x5
	SC620TA										

2. Seals must be ordered for each side of the housing.

3. Optional V-ring available for felt strip seal (FS).



Pillow block housing for bearings with adapter sleeve mounting *(continued)*

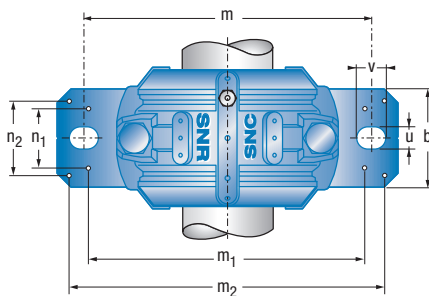
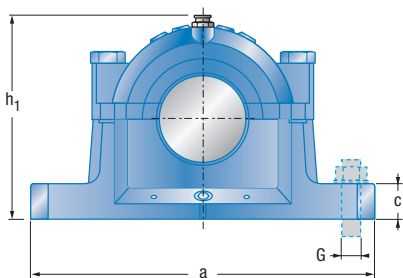

d	Type	Housing dimensions															Weight ¹		
		D	a	b	c	g	h	l	m	G	u	v	h ₁	m ₁	n ₂	m ₂	n ₁	n ₃	≈ [kg]
100	SNC522	200	410	120	45	80	125	175	350	M24	26	32	242	320	88	378	74	110	24.7
110	SNC524	215	410	120	45	86	140	185	350	M24	26	32	271	330	88	378	74	122	30.0
115	SNC526	230	445	130	50	90	150	190	380	M24	28	35	290	370	92	414	80	122	36.6
125	SNC528	250	500	150	50	98	150	205	420	M30	35	42	302	400	108	458	92	128	42.6
135	SNC530	270	530	160	60	106	160	220	450	M30	35	42	323	430	116	486	100	140	55.2
140	SNC532	290	550	160	60	114	170	235	470	M30	35	42	344	450	116	506	100	155	63.0

1. Pillow block housing

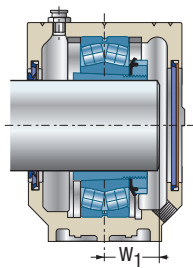

V-ring seal
SC..SV + Cover
SC..EC

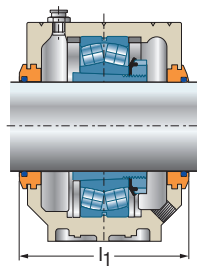

Labyrinth seal
SC..LA

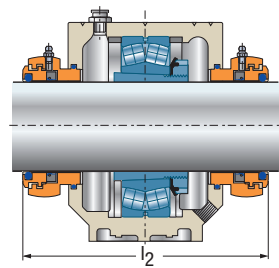

Taconite seal
SC..TA

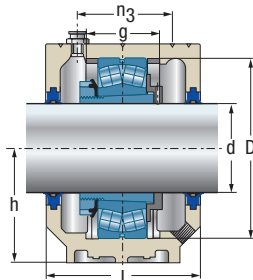

Double lip seal
SC..DS + Regulation disc
RDC

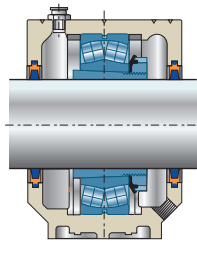

Felt strip seal
SC..FS

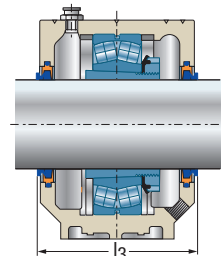

Felt strip seal
SC..FS + V-ring seal
V..A

Housing	Seal ²	V-ring seal ³	Cover	w ₁	l ₁	l ₂	l ₃	Regulation disc	Bearing	Adapter sleeve	Locating ring 2 x per housing
SNC522-619	SC522DS	V100A	SC522-619EC	42.5	189	242	202	RDC522	1222K	H222	FR200x21
	SC522FS			50.0					2222K	H322	FR200x13.5
	SC522SV			50.0					2222K	H322	FR200x13.5
	SC522LA			58.4					2322K	H2322	FR200x5.1
	SC522TA										
SNC524-620	SC524DS	V110A	SC524-620EC	53.5	199	249	216	RDC524	22224K	H3124	FR215x14
	SC524FS			62.5					23224K	H2324	FR215x5
	SC524SV										
	SC524LA										
	SC524TA										
SNC226-526	SC526DS	V120A	SC226-526EC	57.5	207	259	221	RDC526	22226K	H3126	FR230x13
	SC526FS			65.5					23226K	H2326	FR230x5
	SC526SV										
	SC526LA										
	SC526TA										
SNC228-528	SC528DS	V130A	SC228-528EC	60.5	222	275	236	RDC528	22228K	H3128	FR250x15
	SC528FS			70.5					23228K	H2328	FR250x5
	SC528SV										
	SC528LA										
	SC528TA										
SNC230-530	SC530DS	V140A	SC230-530EC	65.0	236	294	251	RDC530	22230K	H3130	FR270x16.5
	SC530FS			76.5					23230K	H2330	FR270x5
	SC530SV										
	SC530LA										
	SC530TA										
SNC232-532	SC532DS	V140A	SC232-532EC	70.5	254	309	256	RDC532	22232K	H3132	FR290x17
	SC532FS			82.5					23232K	H2332	FR290x5
	SC532SV										
	SC532LA										
	SC532TA										

2. Seals must be ordered for each side of the housing.

3. Optional V-ring available for felt strip seal (FS).



Pillow block housing for bearings with cylindrical bore

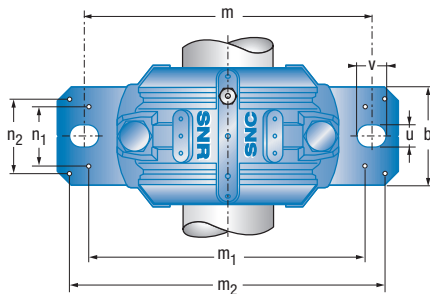
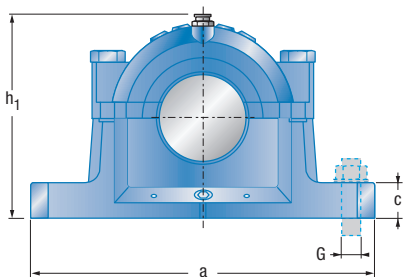

d	Type	Housing dimensions														Weight ¹				
		d ₁	D	a	b	c	g	h	l	m	G	u	v	h ₁	m ₁	n ₁	m ₂	n ₂	n ₃	≈
25	SNC205	30	52	165	46	19	25	40	67	130	M12	15	20	74	116	32	152	28	36	1.5
	SNC305	30	62	185	52	22	32	50	77	150	M12	15	20	89	130	38	172	25	44	2.1
30	SNC206	35	62	185	52	22	32	50	77	150	M12	15	20	89	130	38	172	25	44	2.1
	SNC306	35	72	185	52	22	34	50	82	150	M12	15	20	93	135	38	172	25	46	2.3
35	SNC207	45	72	185	52	22	34	50	82	150	M12	15	20	93	135	38	172	25	46	2.3
	SNC307	45	80	205	60	25	39	60	85	170	M12	15	20	107	160	44	188	34	50	3.1

1. Pillow block housing

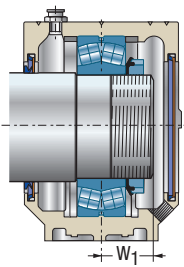

V-ring seal
SC..SV + Cover
SC..EC

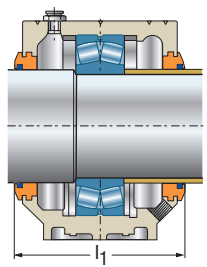

Labyrinth seal
SC..LA

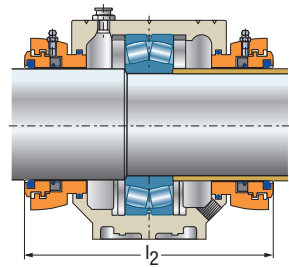

Tacomite seal
SC..TA

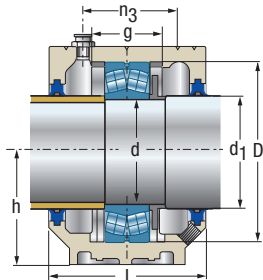

Double lip seal
SC..DS + Regulation disc
RDC

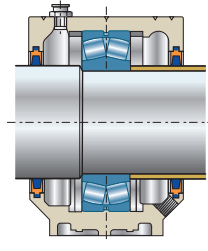

Felt strip seal
SC..FS

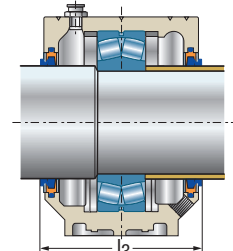

Felt strip seal
SC..FS + V-ring seal
V.A

Housing	Seal ²	V-ring seal ³	Cover	w ₁	l ₁	l ₂	l ₃	Regulation disc	Bearing	Locating ring 2 x per housing
				[mm]						
SNC205	SC205DS	V30A	SC506-605EC	17	89	134	85	RDC205	1205	FR52x5
	SC205FS			18.5					2205	FR52x3.5
	SC205SV			18.5					22205	FR52x3.5
	SC205LA									
	SC205TA									
SNC206-305	SC305DS	V30A	SC507-606EC	18	89	144	95	RDC305	1305	FR62x7.5
	SC305FS			21.5					2305	FR62x4
	SC305SV			18					21305	FR62x7.5
	SC305LA									
	SC305TA									
SNC206-305	SC206DS	V35A	SC507-606EC	18.5	89	144	95	RDC206	1206	FR62x8
	SC206FS			20.5					2206	FR62x6
	SC206SV			20.5					22206	FR62x6
	SC206LA									
	SC206TA									
SNC207-306	SC306DS	V35A	SC509EC	20	94	148	100	RDC306	1306	FR72x7.5
	SC306FS			24					2306	FR72x3.5
	SC306SV			20					21306	FR72x7.5
	SC306LA									
	SC306TA									
SNC207-306	SC207DS	V45A	SC509EC	20	94	148	104	RDC207	1207	FR72x8.5
	SC207FS			22					2207	FR72x5.5
	SC207SV			22.5					22207	FR72x5.5
	SC207LA									
	SC207TA									
SNC208-307	SC307DS	V45A	SC510-608EC	21	94	151	107	RDC307	1307	FR80x9
	SC307FS			26					2307	FR80x4
	SC307SV			21					21307	FR80x9
	SC307LA									
	SC307TA									

2. Seals must be ordered for each side of the housing.

3. Optional V-ring available for felt strip seal (FS).



Pillow block housing for bearings with cylindrical bore *(continued)*

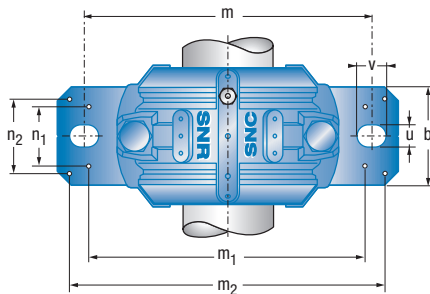
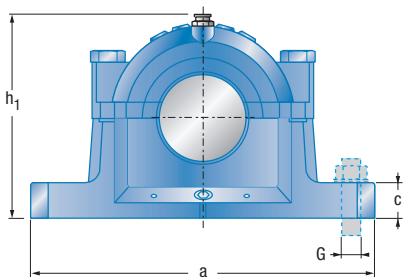

d	Type	Housing dimensions														Weight ¹				
		d_1	D	a	b	c	g	h	l	m	G	u	v	h_1	m_1	n_1	m_2	n_2	n_3	\approx
40	SNC208	50	80	205	60	25	39	60	85	170	M12	15	20	107	160	44	188	34	50	3.1
	SNC308	50	90	205	60	25	41	60	90	170	M12	15	20	113	160	44	188	34	53	3.5
45	SNC209	55	85	205	60	25	30	60	85	170	M12	15	20	110	160	44	188	34	44	3.1
	SNC309	55	100	255	70	28	44	70	95	210	M16	18	24	127	200	49	234	40	56	5.0
50	SNC210	60	90	205	60	25	41	60	90	170	M12	15	20	113	160	44	188	34	53	3.5
	SNC310	60	110	255	70	30	48	70	105	210	M16	18	24	133	200	54	234	40	64	5.3

1. Pillow block housing

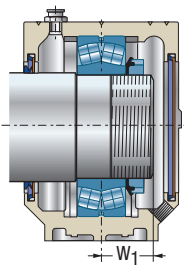

V-ring seal
SC..SV + Cover
SC..EC

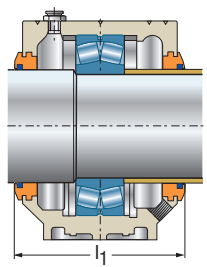

Labyrinth seal
SC..LA

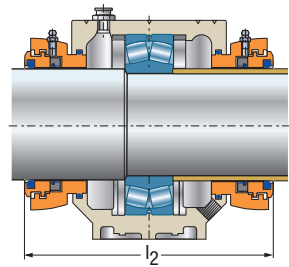

Tacomite seal
SC..TA

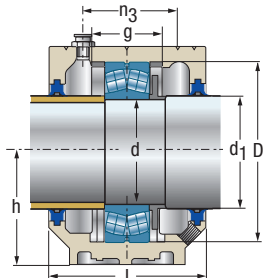

Double lip seal
SC..DS + Regulation disc
RDC

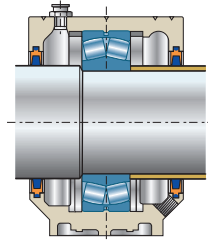

Felt strip seal
SC..FS

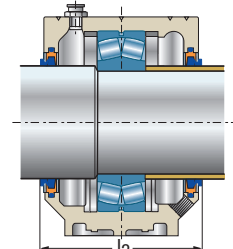

Felt strip seal
SC..FS + V-ring seal
V..A

Housing	Seal ²	V-ring seal ³	Cover	w ₁	l ₁	l ₂	l ₃	Regulation disc	Bearing	Locating ring 2 x per housing	
SNC208-307	SC208DS	V50A	SC510-608EC	20.5	97	151	107	RDC208	1208	FR80x10.5	
	SC208FS			23					2208	FR80x8	
	SC208SV			23					22208	FR80x8	
	SC208LA										
	SC208TA										
SNC210-308	SC308DS	V50A	SC512-610EC	23	102	154	112	RDC308	1308	FR90x9	
	SC308FS			28					2308	FR90x4	
	SC308SV			23					21308	FR90x9	
	SC308LA			28					22308	FR90x4	
	SC308TA										
SNC209	SC209DS	V55A	SC511-609EC	22	97	149	107	RDC209	1209	FR85x5.5	
	SC209FS			24					2209	FR85x3.5	
	SC209SV			24					22209	FR85x3.5	
	SC209LA										
	SC209TA										
SNC211-309	SC309DS	V55A	SC513-611EC	25	107	158	117	RDC309	1309	FR100x9.5	
	SC309FS			30.5					2309	FR100x4	
	SC309SV			25					21309	FR100x9.5	
	SC309LA			30.5					22309	FR100x4	
	SC309TA										
SNC210-308	SC210DS	V60A	SC512-610EC	23.5	102	154	112	RDC210	1210	FR90x10.5	
	SC210FS			25					2210	FR90x9	
	SC210SV			25					22210	FR90x9	
	SC210LA										
	SC210TA										
SNC212-310	SC310DS	V60A	SC515-612EC	27	117	168	127	RDC310	1310	FR110x10.5	
	SC310FS			23.5					2310	FR110x4	
	SC310SV			27					21310	FR110x10.5	
	SC310LA			33.5					22310	FR110x4	
	SC310TA										

2. Seals must be ordered for each side of the housing.

3. Optional V-ring available for felt strip seal (FS).



Pillow block housing for bearings with cylindrical bore *(continued)*

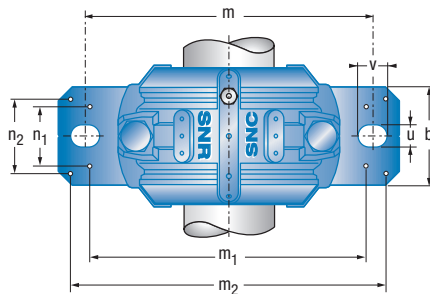
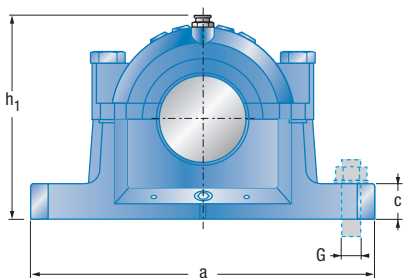

d	Type	Housing dimensions														Weight ¹				
		d ₁	D	a	b	c	g	h	l	m	G	u	v	h ₁	m ₁	n ₁	m ₂	n ₂	n ₃	≈
55	SNC211	65	100	255	70	28	44	70	95	210	M16	18	24	127	200	49	234	40	56	5.0
	SNC311	65	120	275	80	30	51	80	110	230	M16	18	24	148	220	58	252	48	63	6.7
60	SNC212	70	110	255	70	30	48	70	105	210	M16	18	24	133	200	54	234	40	64	5.3
	SNC312	70	130	280	80	30	56	80	115	230	M16	18	24	155	220	58	257	48	72	7.0
65	SNC213	75	120	275	80	30	51	80	110	230	M16	18	24	148	220	58	252	48	63	6.7
	SNC313	75	140	315	90	32	58	95	120	260	M20	22	28	175	252	66	288	52	72	9.5

1. Pillow block housing

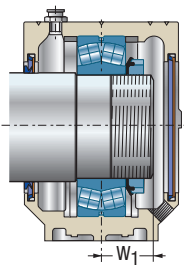

V-ring seal
SC..SV + Cover
SC..EC

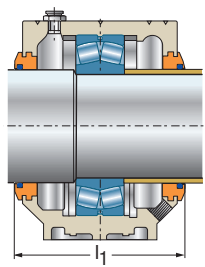

Labyrinth seal
SC..LA

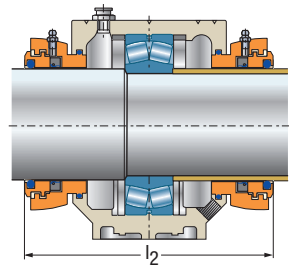

Tacomite seal
SC..TA

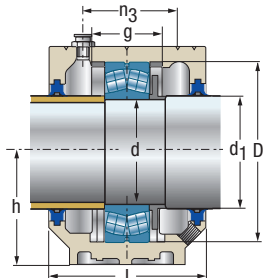

Double lip seal
SC..DS + Regulation disc
RDC

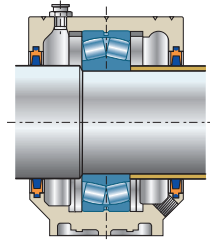

Felt strip seal
SC..FS

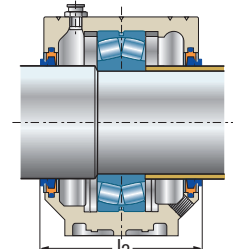

Felt strip seal
SC..FS + V-ring seal
V..A

Housing	Seal ²	V-ring seal ³	Cover	w ₁	l ₁	l ₂	l ₃	Regulation disc	Bearing	Locating ring 2 x per housing
SNC211-309	SC211DS	V65A	SC513-611EC	25	107	158	117	RDC211	1211	FR100x11.5
	SC211FS			27					2211	FR100x9.5
	SC211SV			27					22211	FR100x9.5
	SC211LA									
	SC211TA									
SNC213-311	SC311DS	V65A	SC516-613EC	29	122	172	132	RDC311	1311	FR120x11
	SC311FS			36					2311	FR120x4
	SC311SV			29					21311	FR120x11
	SC311LA			36					22311	FR120x4
	SC311TA									
SNC212-310	SC212DS	V70A	SC515-612EC	26	119	168	132	RDC212	1212	FR110x13
	SC212FS			29					2212	FR110x10
	SC212SV			29					22212	FR110x10
	SC212LA									
	SC212TA									
SNC215-312	SC312DS	V70A	SC518-615EC	30.5	130	181	142	RDC312	1312	FR130x12.5
	SC312FS			38					2312	FR130x5
	SC312SV			30.5					21312	FR130x12.5
	SC312LA			38					22312	FR130x5
	SC312TA									
SNC213-311	SC213DS	V80A	SC516-613EC	27	125	172	137	RDC213	1213	FR120x14
	SC213FS			31					2213	FR120x10
	SC213SV			31					22213	FR120x10
	SC213LA									
	SC213TA									
SNC216-313	SC313DS	V75A	SC216-313EC	32	137	190	147	RDC313	1313	FR140x12.5
	SC313FS			39.5					2313	FR140x5
	SC313SV			32					21313	FR140x12.5
	SC313LA			39.5					22313	FR140x5
	SC313TA									

2. Seals must be ordered for each side of the housing.

3. Optional V-ring available for felt strip seal (FS).



Pillow block housing for bearings with cylindrical bore *(continued)*

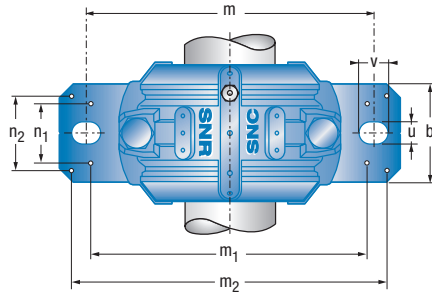
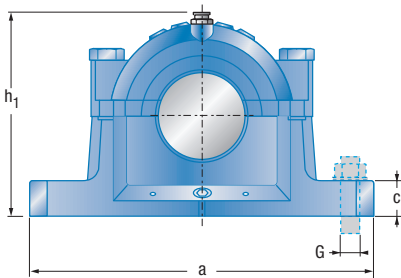

d	Type	Housing dimensions														Weight ¹ ≈ [kg]				
		d ₁	D	a	b	c	g	h	l	m	G	u	v	h ₁	m ₁		n ₁	m ₂	n ₂	n ₃
[mm]																				
70	SNC214	80	125	275	80	30	44	80	115	230	M16	18	23	154	220	58	252	48	66	7.6
	SNC314	80	150	320	90	32	61	95	125	260	M20	22	28	183	252	66	292	52	76	9.8
75	SNC215	85	130	280	80	30	56	80	115	230	M16	18	24	155	220	58	257	48	72	7.0
	SNC315	85	160	345	100	35	65	100	140	290	M20	22	28	192	280	74	319	58	80	12.4
80	SNC216	90	140	315	90	32	58	95	120	260	M20	22	28	175	252	66	288	52	72	9.5
	SNC316	90	170	345	100	35	68	112	145	290	M20	22	28	212	280	70	317	58	88	15.5

1. Pillow block housing

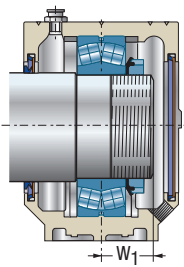

V-ring seal
SC..SV + Cover
SC..EC

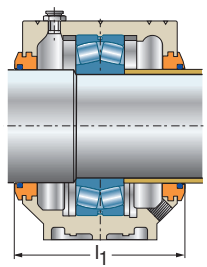

Labyrinth seal
SC..LA

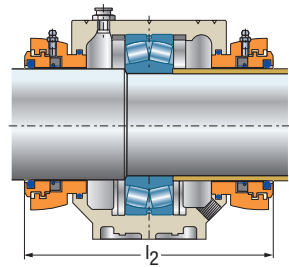

Tacomite seal
SC..TA

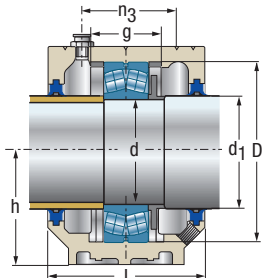

Double lip seal
SC..DS + Regulation disc
RDC

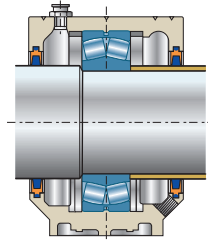

Felt strip seal
SC..FS

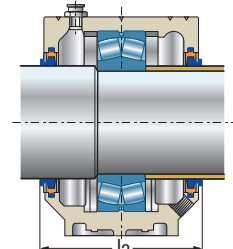

Felt strip seal
SC..FS + V-ring seal
V..A

Housing	Seal ²	V-ring seal ³	Cover	w ₁	l ₁	l ₂	l ₃	Regulation disc	Bearing	Locating ring 2 x per housing
SNC214	SC214DS	V80A	SC517EC	28.5	130	181	142	RDC214	1214	FR125x10
	SC214FS			32					2214	FR125x6.5
	SC214SV			32					22214	FR125x6.5
	SC214LA									
	SC214TA									
SNC217-314	SC314DS	V80A	SC217-314EC	34	140	201	152	RDC314	1314	FR150x13
	SC314FS			42					2314	FR150x5
	SC314SV			34					21314	FR150x13
	SC314LA			42					22314	FR150x5
	SC314TA									
SNC215-312	SC215DS	V85A	SC518-615EC	29	132	181	142	RDC215	1215	FR130x15.5
	SC215FS			32					2215	FR130x12.5
	SC215SV			32					22215	FR130x12.5
	SC215LA									
	SC215TA									
SNC218-315	SC315DS	V85A	SC218-315EC	35	157	216	167	RDC315	1315	FR160x14
	SC315FS			44					2315	FR160x5
	SC315SV			35					21315	FR160x14
	SC315LA			44					22315	FR160x5
	SC315TA									
SNC216-313	SC216DS	V90A	SC216-313EC	30.5	137	190	147	RDC216	1216	FR140x16
	SC216FS			34					2216	FR140x12.5
	SC216SV			34					22216	FR140x12.5
	SC216LA									
	SC216TA									
SNC219-316	SC316DS	V90A	SC519-616EC	37	159	212	172	RDC316	1316	FR170x14.5
	SC316FS			46.5					2316	FR170x5
	SC316SV			37					21316	FR170x14.5
	SC316LA			46.5					22316	FR170x5
	SC316TA									

2. Seals must be ordered for each side of the housing.

3. Optional V-ring available for felt strip seal (FS).



Pillow block housing for bearings with cylindrical bore *(continued)*

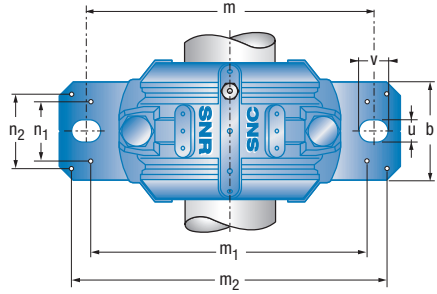
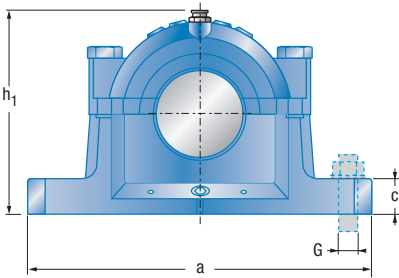

d	Type	Housing dimensions														Weight ¹				
		d_1	D	a	b	c	g	h	l	m	G	u	v	h_1	m_1	n_1	m_2	n_2	n_3	\approx
85	SNC217	95	150	320	90	32	61	95	125	260	M20	22	28	183	252	66	292	52	76	9.8
	SNC317	95	180	380	110	40	70	112	160	320	M24	26	32	215	300	78	348	66	104	18.7
90	SNC218	100	160	345	100	35	65	100	140	290	M20	22	28	192	280	74	319	58	80	12.4
	SNC318	105	190	380	110	40	74	112	160	320	M24	26	32	220	300	78	348	66	104	18.5
95	SNC219	110	170	345	100	35	68	112	145	290	M20	22	28	212	280	70	317	58	88	15.5
	SNC319	110	200	410	120	45	80	125	175	350	M24	26	32	242	320	88	378	74	110	24.8

1. Pillow block housing

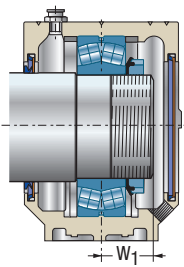

V-ring seal
SC..SV + Cover
SC..EC

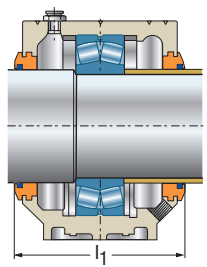

Labyrinth seal
SC..LA

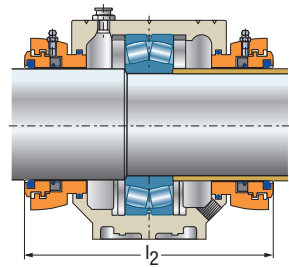

Tacomite seal
SC..TA

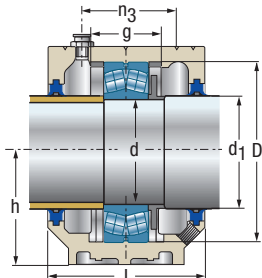

Double lip seal
SC..DS + Regulation disc
RDC

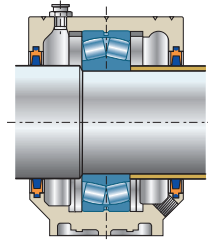

Felt strip seal
SC..FS

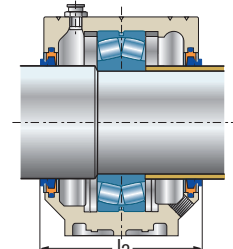

Felt strip seal
SC..FS + V-ring seal
V..A

Housing	Seal ²	V-ring seal ³	Cover	w ₁	l ₁	l ₂	l ₃	Regulation disc	Bearing	Locating ring 2 x per housing
SNC217-314	SC217DS	V95A	SC217-314EC	33.5	142	201	152	RDC217	1217	FR150x16.5
	SC217FS			37.5					2217	FR150x12.5
	SC217SV			37.5					22217	FR150x12.5
	SC217LA									
	SC217TA									
SNC220-317	SC317DS	V95A	SC520-617EC	40	174	227	187	RDC317	1317	FR180x14.5
	SC317FS			49.5					2317	FR180x5
	SC317SV			40					21317	FR180x14.5
	SC317LA			49.5					22317	FR180x5
	SC317TA									
SNC218-315	SC218DS	V100A	SC218-315EC	35.5	157	216	167	RDC218	1218	FR160x17.5
	SC218FS			40.5					2218	FR160x12.5
	SC218SV			40.5					22218	FR160x12.5
	SC218LA			46.8					23218	FR160x6.25
	SC218TA									
SNC318-618	SC318DS	V110A	SC318-618EC	42	174	227	191	RDC318	1318	FR190x15.5
	SC318FS			52.5					2318	FR190x5
	SC318SV			42					21318	FR190x15.5
	SC318LA			52.5					22318	FR190x5
	SC318TA									
SNC219-316	SC219DS	V110A	SC519-616EC	36.5	159	212	176	RDC219	1219	FR170x18
	SC219FS			42					2219	FR170x12.5
	SC219SV			42					22219	FR170x12.5
	SC219LA									
	SC219TA									
SNC222-319	SC319DS	V110A	SC522-619EC	43	189	242	206	RDC319	1319	FR200x17.5
	SC319FS			54					2319	FR200x6.5
	SC319SV			43					21319	FR200x17.5
	SC319LA			54					22319	FR200x6.5
	SC319TA									

2. Seals must be ordered for each side of the housing.

3. Optional V-ring available for felt strip seal (FS).



Pillow block housing for bearings with cylindrical bore *(continued)*

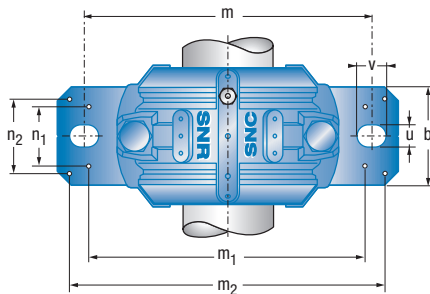
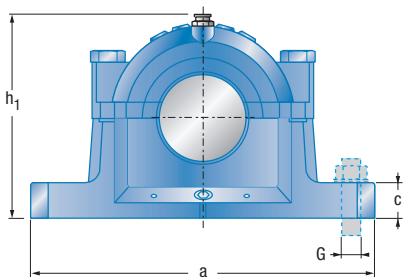

d	Type	Housing dimensions															Weight ¹ ≈ [kg]			
		d ₁	D	a	b	c	g	h	l	m	G	u	v	h ₁	m ₁	n ₁		m ₂	n ₂	n ₃
[mm]																				
100	SNC220	115	180	380	110	40	70	112	160	320	M24	26	32	215	300	78	348	66	104	18.7
	SNC320	115	215	410	120	45	86	140	185	350	M24	26	32	271	330	88	378	74	122	30.4
110	SNC222	125	200	410	120	45	80	125	175	350	M24	26	32	242	320	88	378	74	110	24.8
120	SNC224	135	215	410	120	45	86	140	185	350	M24	26	32	271	330	88	378	74	122	30.4
130	SNC226	145	230	445	130	50	90	150	190	380	M24	28	35	290	370	92	414	80	122	36.6
140	SNC228	155	250	500	150	50	98	150	205	420	M30	35	42	302	400	108	458	92	128	42.5

1. Pillow block housing

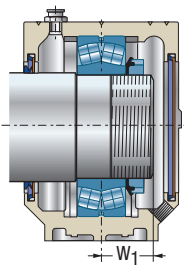

V-ring seal
SC..SV + Cover
SC..EC

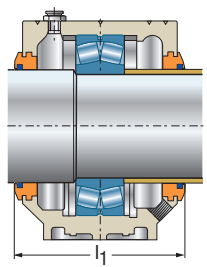

Labyrinth seal
SC..LA

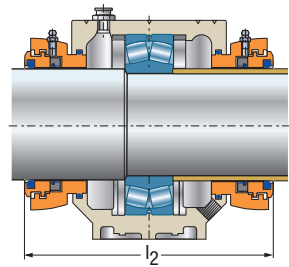

Tacomite seal
SC..TA

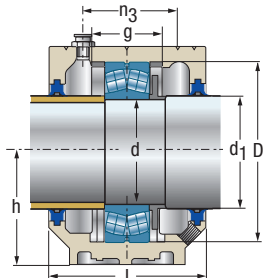

Double lip seal
SC..DS + Regulation disc
RDC

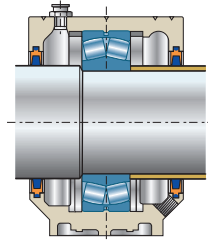

Felt strip seal
SC..FS

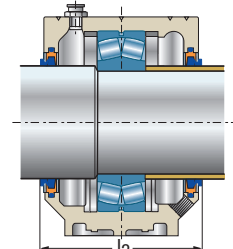

Felt strip seal
SC..FS + V-ring seal
V..A

Housing	Seal ²	V-ring seal ³	Cover	w ₁	l ₁	l ₂	l ₃	Regulation disc	Bearing	Locating ring 2 x per housing
SNC220-317	SC220DS	V120A	SC520-617EC	38.5	177	227	191	RDC220	1220	FR180x18
	SC220FS			44.5					2220	FR180x12
	SC220SV			44.5					2220	FR180x12
	SC220LA			51.7					23220	FR180x4.85
	SC220TA									
SNC224-320	SC320DS	V120A	SC524-620EC	45.0	200	249	216	RDC320	1320	FR215x19.5
	SC320FS			58.0					2320	FR215x6.5
	SC320SV			45.0					21320	FR215x19.5
	SC320LA			58.0					22320	FR215x6.5
	SC320TA									
SNC222-319	SC222DS	V130A	SC522-619EC	41.5	193	242	206	RDC222	1222	FR200x21
	SC222FS			49.0					2222	FR200x13.5
	SC222SV			49.0					2222	FR200x13.5
	SC222LA			57.4					23222	FR200x5.1
	SC222TA									
SNC224-320	SC224DS	V140A	SC524-620EC	53.5	201	249	216	RDC224	2224	FR215x14
	SC224FS			62.5					23224	FR215x5
	SC224SV									
	SC224LA									
	SC224TA									
SNC226-526	SC226DS	V150A	SC226-526EC	57.5	201	259	221	RDC226	2226	FR230x13
	SC226FS			65.5					23226	FR230x5
	SC226SV									
	SC226LA									
	SC226TA									
SNC228-528	SC228DS	V160A	SC228-528EC	60.5	221	275	241	RDC228	2228	FR250x15
	SC228FS			70.5					23228	FR250x5
	SC228SV									
	SC228LA									
	SC228TA									

2. Seals must be ordered for each side of the housing.

3. Optional V-ring available for felt strip seal (FS).



Pillow block housing for bearings with cylindrical bore *(continued)*

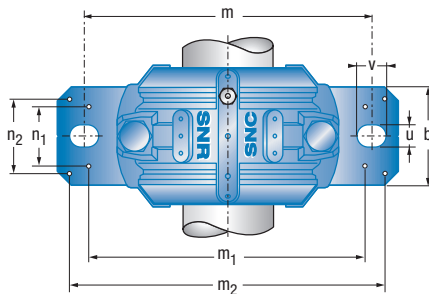
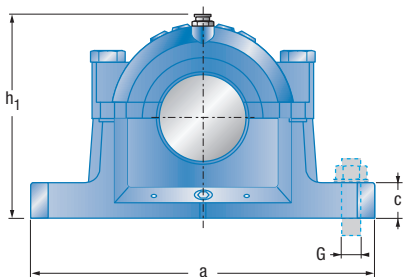

d	Type	Housing dimensions													Weight ¹						
		d_1	D	a	b	c	g	h	l	m	G	u	v	h_1	m_1	n_1	m_2	n_2	n_3	\approx	[kg]
150	SNC230	165	270	530	160	60	106	160	220	450	M30	35	42	323	430	116	486	10	140	55.2	
160	SNC232	175	290	550	160	60	114	170	235	470	M30	35	42	344	450	116	506	100	155	63.0	

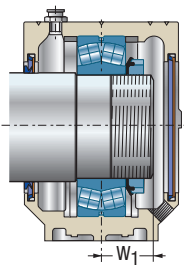

V-ring seal
SC..SV + Cover
SC..EC

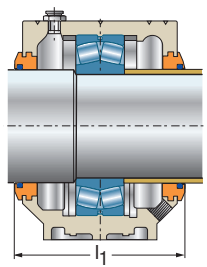

Labyrinth seal
SC..LA

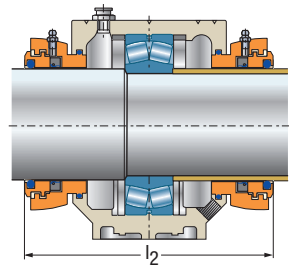

Tacanite seal
SC..TA

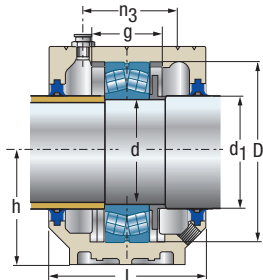

Double lip seal
SC..DS + Regulation disc
RDC

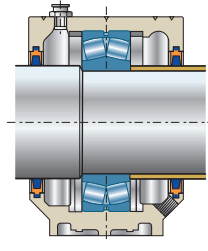

Felt strip seal
SC..FS

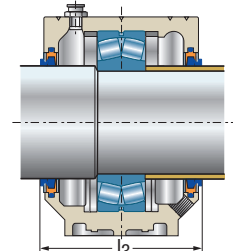

Felt strip seal
SC..FS + V-ring seal
V..A

Housing	Seal ²	V-ring seal ³	Cover	w ₁	l ₁	l ₂	l ₃	Regulation disc	Bearing	Locating ring 2 x per housing
SNC230-530	SC230DS	V170A	SC230-530EC	65.0	236	294	256	RDC230	22230	FR270x16.5
	SC230FS			23230					FR270x5	
	SC230SV									
	SC230LA									
	SC230TA									
SNC232-532	SC232DS	V180A	SC232-532EC	70.5	251	309	271	RDC232	22232	FR290x17
	SC232FS			23232					FR290x5	
	SC232SV									
	SC232LA									
	SC232TA									

2. Seals must be ordered for each side of the housing.

3. Optional V-ring available for felt strip seal (FS).



Maintenance

Maintenance products	676
■ SNR LUB Greases	676
■ Automatic lubricator SNR	676
■ Grease gun for bearings	677
■ Induction heaters	677
■ Heat insulating gloves	677
■ Installation kit	678
■ Spanner wrenches	678
■ Fitting compound	678
■ Hydraulic extractor (bearing puller)	679
■ Calibrated feeler gauges	679
■ Laser-targeting thermometer	679
SNR Industry Services	680
■ Expertise	680
■ Fitting/dismounting of bearings	680
■ Shaft alignment	681
■ Vibration analysis	681
■ Spindle renewal for machine-tools	681



Maintenance products

Products that meet your expectations



SNR LUB greases

Advantages	Description	Operating conditions	Applications
<ul style="list-style-type: none"> • Reliable : developed by a bearing manufacturer and approved petroleum suppliers. • Adapted to the needs: <ul style="list-style-type: none"> - different types as per applications - packaging method adapted to the types of grease. 	<ul style="list-style-type: none"> • NLGI 2 grade for all greases. • Operating temperature between -50°C (-122°F) to +250°C (+482°F) according to type. • Very good resistance to water and corrosion. 	Range adapted to following applications: <ul style="list-style-type: none"> • Multiservice MS, • Extreme pressure EP, • High speed GV+, • high viscosity FV, • Low speed, extreme pressure VX, • High temperature HT, • Very high temperature THT, • Food compatible grease AL1. 	<ul style="list-style-type: none"> • All types of bearings, pillow blocks and mounted units as per load and environmental requirements.



SNR automatic lubricator

Advantages	Description	Operating conditions	Applications
<ul style="list-style-type: none"> • Safe: inert gas produced within a sealed chamber. • Cerchar and Ineris approvals: electrical equipment usable in an explosive atmosphere. • Reliable lubrication: not readily accessible or dangerous areas. • Automatic: less frequent monitoring. • Flowrate adjustment: one product for all applications. • Sealed: operation possible when immersed. 	<ul style="list-style-type: none"> • Flowrate programmable via switches. • Can be stopped during operation (ON/OFF). • Pressure: 3 bar (43 psi) maximum. • Volume: 125 cm³ (4,2 ozfl). • Different types of grease can be used. 	<ul style="list-style-type: none"> • Direct installation on the component to be lubricated. • Remote installation (1m or 3 ft away) in case of excessive temperature, uneasy access or vibration. • Range of lubricators: <ul style="list-style-type: none"> AL1 EP HT MS VX 	<ul style="list-style-type: none"> • All types of machines regardless of the environment.

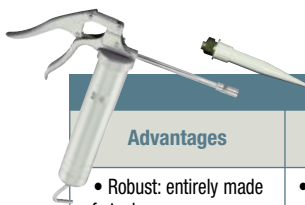

Grease gun for bearings

Advantages	Description	Operating conditions	Applications
<ul style="list-style-type: none"> • Robust: entirely made of steel. • Practical use: knurled body for an excellent grip, the pump can be actuated with one hand. • Precise: especially designed SNR union combined to a special profile greasing nozzle to inject the grease at the right point. • Clean: clean for the environment and the use. 	<ul style="list-style-type: none"> • Material: heavy steel plate. • Weight: 2-1/2 pounds with steep section and clip. • Content: 500 cm³. • Operating pressure: 180 bars. • Maximum pressure: 360 bars. • Flow rate: 0.80 cm³. • Greasing accessories supplied with the gun. 	<ul style="list-style-type: none"> • Maintenance operations (greasing, regreasing). 	<ul style="list-style-type: none"> • For all bearings.

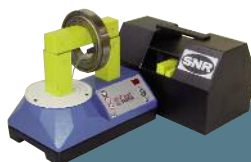

Induction heaters (Fast Therm 20/35/150/300/600/1000)

Advantages	Description	Operating conditions	Applications
<ul style="list-style-type: none"> • Easy to use: pivot arm, operator's safety, cleanliness. • Heating control and safety: temperature control. • Efficiency: turbo-boost technology that heats the part twice as rapidly. 	<ul style="list-style-type: none"> • 6 devices range. • Automatic demagnetizing on completion of the cycle. 	<ul style="list-style-type: none"> • All circular parts with a maximum bore diameter from 215 to 1150 mm. 	<ul style="list-style-type: none"> • Steel ring bearings, gear etc. with interference fit on the shaft.



Heat-insulating gloves

Advantages	Description	Operating conditions	Applications
<ul style="list-style-type: none"> • Non-flammable, resistance to temperatures up to: +350°C / 660°F. • High protection: arm + hand (glove length: 35 cm / 14 inches). • Very high resistance to cuts, tears and abrasion. 	<ul style="list-style-type: none"> • Made of Kevlar®. • Certified for EN388 mechanical and EN407 thermal risks. 	<p>–</p>	<ul style="list-style-type: none"> • Handling of oily and hot bearings.



Maintenance products *(continued)*



Installation kit

Advantages	Description	Operating conditions	Applications
<ul style="list-style-type: none"> • Do not damage the bearings during installation. • Complete kit. • Practical, thorough transportable kit. 	<ul style="list-style-type: none"> • 3 impact tubes. • 1 set of 33 impact rings. • 1 special hammer, anti-bounce, shot-loaded, to ensure maximum impact. 	-	<ul style="list-style-type: none"> • Bearings (bore diameter from 10 to 55 mm), spacer rings, pulleys and seals installation



Spanner wrench

Advantages	Description	Operating conditions	Applications
<ul style="list-style-type: none"> • Solid, safe, simple to use. • 5 sizes to cover all needs. • Capacity: 15 to 180 mm. • Pins are heat-treated to 40HRc rockwell hardness. 	<ul style="list-style-type: none"> • 2 types of wrenches to tighten drilled nuts (e.g. precision nuts) and castellated wrenches to tighten nuts with straight slots (or castellated nuts). 	<ul style="list-style-type: none"> • 5 sizes: 15-35 mm; 35-50 mm; 50-80 mm; 80-120 mm; 120-180 mm. 	<ul style="list-style-type: none"> • Tightening and removal operations for standard and precision nuts.



Fitting compound

Advantages	Description	Operating conditions	Applications
<ul style="list-style-type: none"> • Contact corrosion reduction. • Extended shaft and bearing housing life. • Water and washout resistant. • Stick-slip reduction. 	<ul style="list-style-type: none"> • Composition: lithium soap, synthetic oil, solid organic lubricants. • Operating temperature: -45°C (110°F) to +150°C (302°F), • NLGI grade: 1. 	-	<ul style="list-style-type: none"> • Installation or removal by fitting (bearings, wheels, flanges,...).



Hydraulic extractor

Advantages	Description	Operating conditions	Applications
<ul style="list-style-type: none"> • Simple thanks to its integrated hydraulic pump. • Solid, robust. • No energy loss. 	<ul style="list-style-type: none"> • 2 or 3 interchangeable jaws. • Light weight. • Extraction force: 10 tons. 	<ul style="list-style-type: none"> • Always position the protection cover over the jaws when using the extractor. 	<ul style="list-style-type: none"> • Removal of bearing assemblies. • Removal of bearings either by the bore or by the outer diameter, by reversing the jaws.



Calibrated feeler gauges

Advantages	Description	Operating conditions	Applications
<ul style="list-style-type: none"> • High precision measurement. • Set of gauges protected by a steel frame. 	<ul style="list-style-type: none"> • Set of 18 gauges, round tip. • Calibrated to 1/100th. • 2 lengths available: 90x10 mm to 150x10 mm. 	<ul style="list-style-type: none"> • Control of bearings fit. • 2 sets available (+1 in inch). 	<ul style="list-style-type: none"> • Internal radial clearance measurement in spherical and cylindrical roller bearings.



Laser-targeting thermometer

Advantages	Description	Operating conditions	Applications
<ul style="list-style-type: none"> • Simple to use. • Precise. 	<ul style="list-style-type: none"> • Non-contact infrared measurement. • Emissivity adjustment 0.20 to 1.00. • °C/°F switching. 	<ul style="list-style-type: none"> • Functional monitoring. 	<ul style="list-style-type: none"> • Bearings, plain bearings, lubrication systems, surface temperature, live components...



SNR Industry services

→ Expertise

If the bearing is damaged or operates incorrectly, our experts are at your disposal to analyse the failed bearing. They can visit your site upon request.



In case of premature bearing damage, the bearing state will provide significant information.

Just send the bearing, without cleaning it along with an analysis request sheet, duly completed (available from your SNR contact or distributor).

Please provide maximum information concerning the bearing operation and environment.

→ Installation / Removal

Our experts can intervene on-site, everywhere in the world and on short notice.

Their mission consists of providing suitable consulting advice for bearing installation and removal to ensure optimum service life.

Therefore, this service is effective at all collaboration stages between SNR and its clients, before and after sales, and also during the bearing service life. If you do not possess suitable means, or if you lack the time or availability, SNR is there to help you.



→ Shaft alignment

Misalignment causes stress loading and vibrations that give rise to premature deterioration of bearings, and also coupling, packing and sealing, etc.

Abnormal stress loading associated with misalignment also causes increased energy consumption. Misalignment has a direct impact on maintenance costs and the availability of your production tool.

By entrusting your shaft alignment operations to the teams of SNR experts, you will guarantee the precision of alignment and will ensure the quality of your rotating machines elements.

→ Vibration analysis

Vibration analysis is the most commonly used on-site condition monitoring method for rotating machines, which are essential elements at the heart of the manufacturing process. Measurements on operating machines are easy to implement and the process allows early detection of most faults encountered on production machines.

Many anomalies such as shaft line unbalance play, misalignment of coupled machines, coupling deterioration, clearances, bearing wear, or even electrical faults can be detected with sufficient anticipation to plan an intervention before failure.

SNR has developed a whole range of measuring and monitoring instruments in order to accurately analyse all environmental constraints likely to affect correct operation of your facilities and, notably, your bearings.

In order to detect weak points in your equipment and facilities and solve them, we also propose a range of products and services, suitable for vibration monitoring of the rotating machines, together with our partner, 01dB, a renowned expert in this field.



→ Spindle renewal for machine-tools*

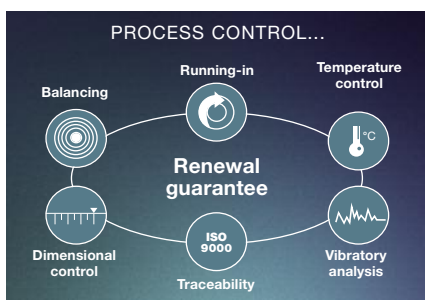

Based on its extensive experience in the field of machine-tool bearings and in the machine-tool spindle renewal activity for the maintenance of its own machine fleet, SNR proposes a machine-tool spindle renewal service to its French clients.

This renewal service is proposed for all types of spindles (either mechanical or electro-mechanical), all activity sectors (mechanics, platurgy, wood industry, etc.) and all bearing makes or brands.

* Service available in France only.



Other products

Linear motion	684
■ AXC compact modules	685
■ AXDL parallel module	685
■ AXLT linear tables	686
■ AXS systems modules	686
■ Specific solutions	687
Special bearings	688
■ Description and capabilities	688
■ Series	690
■ Individualized solutions	692
<i>Ball bearings units</i>	692
<i>Split housing units</i>	693
<i>Complete systems</i>	693
Aerospace	694
Automotive	695
Railway applications	696
Other applications	697
■ SNR and quarries – mines	697
■ SNR and paper mill industry	698
■ SNR and steel industry	698
■ SNR and agri-food industry	699



Linear motion

The range of SNR linear modules and tables offers many solutions for production automation, notably in assembly, measurement or handling sectors.

■ The modular, flexible design allows us to propose a type of drive and guidance function perfectly tailored to each application, with extensive specific adaptation capabilities. High quality components guarantee optimum service lives and reliability. Finally, low product footprint facilitates installation in all types of mechanical systems.

The SNR technicians at our design offices provide technical support during solution-finding and recommendation phases.

All SNR linear motion units are developed, manufactured and tested in our Bielefeld workshop (Germany). Linear module production has been certified since January 2000 to DIN EN ISO standard 9001:2000. If application requires, modules can be assembled under protected environment, in a clean room.

SNR linear modules address the most diversified application in various industrial sectors: automation, machine-tools, electrotechnology, electronics, motor industry, printing, special machine construction, white rooms in semi-conductor and food industries.

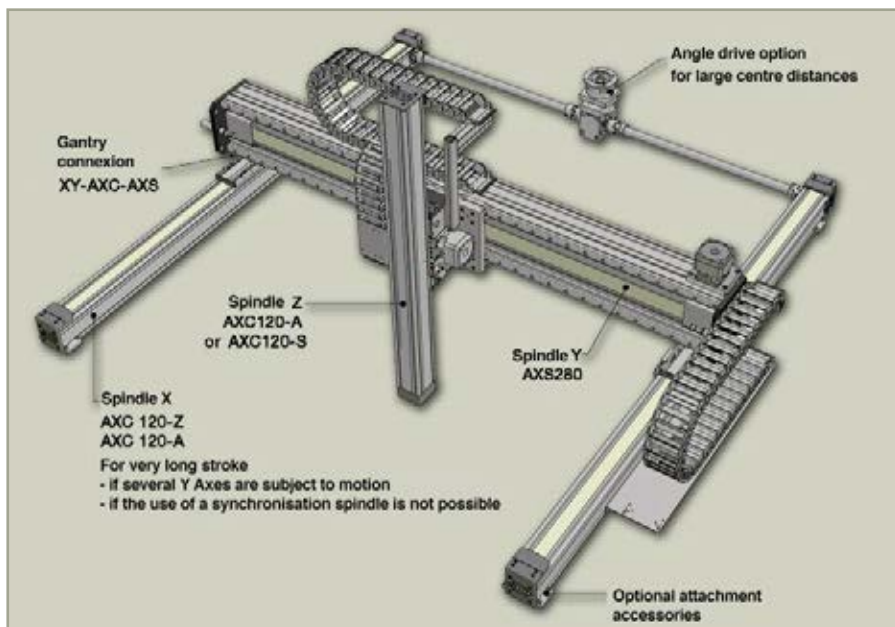

■ The linear motion range breaks down into four complementary families:

- **AXC compact modules:** based on open sections integrating guiding and driving functions for general applications.
- **AXDL parallel module:** excellent high levels of torsion rigidity and two interior parallel linear motion systems.
- **AXLT linear tables:** for applications requiring accuracy and stiffness.
- **AXS system modules:** based on close sections, tailored to heavy load handling applications.

AXC compact modules

The range of AXC compact modules is built on 40, 60, 80 and 120 mm aluminium sections. These products feature versatility and compactness. They can be used either singly or interconnected thanks to a range of interconnection components allowing multi-axis assembly creation.

■ Various guide / drive variants are proposed to adapt the mechanical solution to each application:

- Roller drive or various types of rails / boltage cursors
- Ball screw or notched belt drive

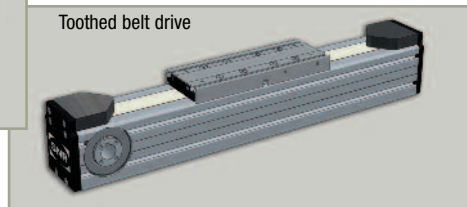
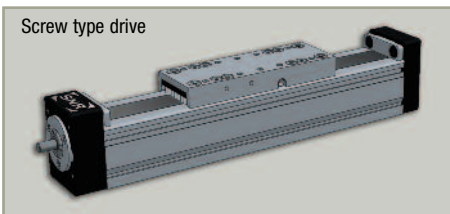

■ Various suitable optional items are proposed:

Protection strip, pre-tensioning, clamps and coupling for motor mount, integral reduction gears, limit switches, ...

AXDL parallel module

The three of the available size – 110, 160, 240 – could mount alternatively with toothed belt or ball screw drive. In the torsion rigid aluminium were profile parallel integrated. As a linear motion alternative Roller guide or profile rail guide could be chosen. With a coordinated construction the engineers have been succeed an extremely favourable ratio between the over-all length and the possible stroke.



Linear motion *(suite)*

AXLT linear tables

■ AXLT series linear tables are tailored to high load applications requiring good accuracy. The standard range is built on 155, 225, 325 and 455 mm wide aluminium support plates. For applications where the table plays a structural role, the base plates can be delivered in steel construction.

Carriage drive is ensured by ball screws or trapezoidal thread screws. Loads are sustained by engaged ball guides. These mechanical components are protected from outside environment by boots.

■ **Optional items are available:** sensors, motor coupling and flanges, belt angle drive,...

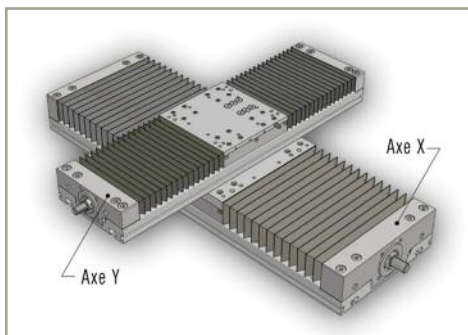

AXS system modules

■ AXS modules are required to handle heavy loads. The range breaks down into horizontal gantries, vertical lifting modules and telescopic modules.

Horizontal modules are based on large-section closed aluminium beams with high capacity ball-type guide pads and a belt or rack drive system. These modules can move loads up to 6,000 Kg with cantilever lengths (overhang) up to 10 m.

For vertical motion, lifting modules can displace loads up to 1,000 Kg thanks to reinforced gear-rack systems. Design allows use of these modules on long spans, with various moving carriages, independent from one another.

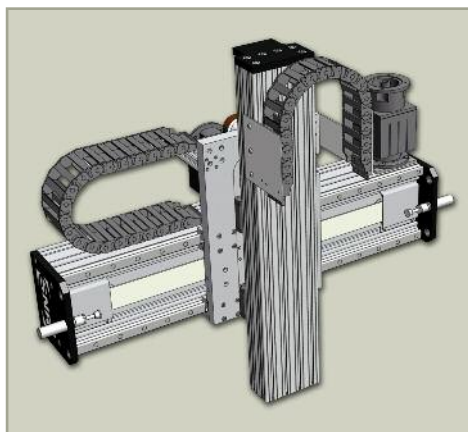

Finally, telescopic modules can be used for vertical or horizontal displacements requiring low footprint. Design allows very high travelling rates (up to 10 m/s).

All AXS range modules can easily be combined to compose full-featured assemblies by integrating various optional items (position sensors, pods, cable carrier chains, ...)

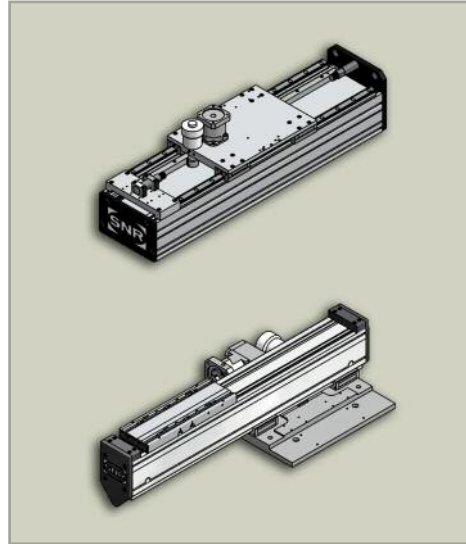

Specific solutions

■ In addition to the standard range, SNR proposes solutions addressing high technology applications which require specific technical solutions.

Notably, the standard range can be adapted to address particular environmental requirements, such as in white rooms or in agri-food systems. When standard solutions are not suitable, the SNR design office is at your disposal for designing specific solutions tailored to your own needs.



Special bearings

Description and capabilities

■ The design office engineers and technicians are trying constantly to improve the technical and economic performance of their products by expanding their limits.

SNR has found that the synergy obtained by working hand-in-hand with our customers results in original and innovative approaches to rotational functions that can remove some of the constraints limiting their products.

A fruitful collaboration must be tangible at all levels : technical creativity, lasting economic competitiveness and industrial responsiveness. SNR has dedicated the necessary human and material resources to meet the design, production and commercial requirements of such collaborations:

- All developments follow our ISO 9001 certified procedures
- Prototypes and pre-production models can be rapidly produced to validate calculated performance. If necessary, a test centre is available to test variants of your products.
- An industrialization and production unit, which is specialized for small and medium quantities, can devote the necessary attention to the particular details of your product.



- Field service augmented by powerful technical support groups facilitate product integration into its application.
- Product and service quality require reciprocal commitments. For this purpose, SNR proposes a cooperation agreement which details these commitments and provides an additional guarantee of success.







■ The agreement is grounded on a program based on previous issues, whatever the industry or branches where special SNR bearings are used. The special products developed by SNR directly benefit from State-of-the-Art innovations from our research & development plan.



Special bearings *(continued)*

Series

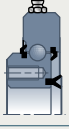
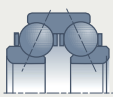
■ Comparative table of different bearing types

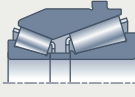
Product		Market	Capabilities	
Type		Examples of applications	Radial load	Axial load
QR		Robotics, special reducing gears, civil engineering, mines, transport, telecommunications, agricultural machinery, railway applications.		
QJ		Automatic systems, robotics, special reducing gears, civil engineering, mines, transport, handling, agricultural machinery, railway applications.		
AB		Transport, agricultural machinery, textiles, material handling, lifting, reducing gears, railways applications, food industry, machine-tools, pump-turbines, chemical industry, cam and conveyor rollers.		
GB		Transport, civil engineering equipment, mines, textiles, agriculture, food industry, material handling, reducing gear, gearboxes.		
N		Transport, agricultural machinery, iron and steel industry, printing, civil engineering, railway applications, textiles.		
GNU		Iron and steel industry, food industry, reducing gears, conveyors, railway applications, civil engineering.		
FC		Transport, railway applications, iron and steel industry, agriculture, civil engineering, mines, material handling.		

Our applications engineers will determine the SNR solution that the best meets your requirements.

- QR** : crossed roller bearings
- QJ** : ball bearings with 4 contact points
- AB** : single-row ball bearings
- GB** : double-row angular contact ball bearings TWINLINE
- N** : cylindrical roller bearing
- GNU** : single or double-row cylindrical roller bearing with a large outer ring
- FC** : double tapered bearings

Capabilities			Additional Characteristics				
Speed of rotation	Canting moment	Friction moment	Lubrication	Protection	Adjustment	Connection	Transmission

Special bearings *(continued)*

Customized solutions

→ Self-aligning bearings

In addition to a very extensive range of standard self-aligning bearings, SNR can propose solutions tailored to your requirements and help you face the challenges in terms of bearing applications.

Together with highly diversified raw material choices such as grey iron, modular iron, cast steel, steel sheet or plate, or thermoplastic resin, SNR can also propose tailor-made designs.

Efficient sealing systems which ensure suitable bearing operation were specially developed for our clients.

Bearing and insert surface protection is ensured thanks to high performance processes such as nickel plating or galvanising.

SNR bearings can be painted, coated by spraying process or finished following innovative methods.

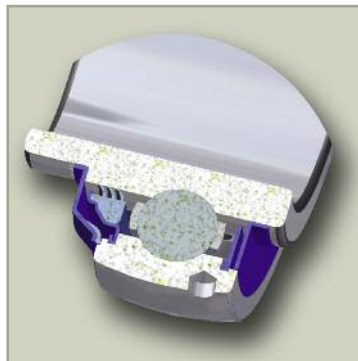

→ Split housing units

Special applications require special concepts.

For example, SNR proposes base plate bearing units for high load requirements such as mining, or industrial fan bearings in cement mills. Through its extensive technological knowledge of bearings and long experience in this sector, SNR has become the ideal partner.

In addition to standard designs, we can propose customized solutions designed to enhance our clients' machine performance and service life.

We have integrated many environment criteria and optimised, amongst others, the bearing sealing systems. We have also equipped the bearings with oil circulation or vapour lubrication devices.

As for self-aligning bearings, pillow block housings can be manufactured on demand, from modular iron or steel casting.

We develop and manufacture tailored bearing variants allowing perfect integration into your applications.

We also propose particularly attractive and competitive turnkey solutions comprising tailor-made bearing-bearing unit-shaft assemblies to be installed directly.



→ Complete systems

One of SNR's main assets is its capacity to develop system solutions in cases where standard solutions are not applicable.



Beyond the bearing's main function, we take into account mechanical interfaces, thereby simplifying integration into the existing system. This cost-saving approach also reduces commissioning times and incorrect assembly errors.

Your single source: SNR.



Aerospace

Aerospace: SNR on board means comfort

Today, SNR bearings are chosen in the major aerospace programmes: Airbus, Boeing, Dassault, Ariane 5 European launcher... they all use engines equipped with SNR bearings. Likewise, helicopter manufacturers are proud to rely on the European leader of helicopter transmission bearings.

The significant resources assigned to R&D and tests by SNR and a good comprehension of specifications have enabled the company to meet the increasing requirements of its clients for more than 50 years.

Quality, reliability and efficient organisation have positioned SNR amongst the major leaders of the Aerospace sector worldwide.



Production methods and means, high training and qualification have enabled our Aerospace division to obtain quality certificates from the major Aeronautics manufacturers.

Aerospace requires the highest performance bearings with highest reliability. Turbojet and turboshaft engines expose the bearing to high speeds, high temperatures, while requiring weight savings. In helicopter transmissions, bearings are subject to high loads, vibrations and structural deformation.

As a complement to OEM activity, SNR aerospace has obtained the required approvals delivered by civil aviation authorities (JAA, FAA, CAAC) to propose to engine and aircraft operators and after-sales facilities a wide range of services broken down into two main categories:

- aerospace bearing maintenance.

The "SNR MRO Services" offer, exhaustively addresses the requirements of engine maintenance facilities, either affiliated with airlines, OEM's, or independant contractors.

- aftermarket spares.

Automotive

Automotive: the European reference

■ In the world of motor car and OEM manufacturers, the conventional "supplier" was replaced by a concept of "cooperating company", leading the suppliers and their clients to jointly work and develop common technologies and synergies. SNR is one of the major cooperating companies in the automotive sector and this cooperation process is deeply rooted in its culture. With bearings present in 8 of the 10 best selling cars in Europe, SNR clearly identifies itself as the European leader of wheel bearings.



SNR follows the worldwide market evolution and acts as a privileged contact for the leading motorcar and OEM manufacturers, covering the whole range of motor and bearing applications:



- ▶ Wheel bearings, 1st, 2nd and 3rd generations
- ▶ Chassis
- ▶ Gearbox
- ▶ Transmission shafts
- ▶ Steering column
- ▶ Engines and accessories

SNR created ASB® (Active Sensor Bearing), an instrumented bearing which has become a worldwide standard, illustrating the company's involvement in automotive sector progress and development. The ASB® technology has now been adopted by all the world leaders in the bearings sector in Europe and Japan.

This technology is a decisive contribution to design and implementation of State-of-the-Art technologies referred to as "mechatronics", which currently change the conventional vehicle concepts and provide the driver with a leading-edge advantage in terms of safety and performance.

Our technical competence and know-how are also at your disposal for the Aftermarket, which directly benefits from SNR's prevailing position in the OEM sector as well as its genuine product offer.



Rail

SNR solutions : the future on rails

■ SNR solutions : the future on rails

SNR, at the very heart of big European rail projects for more than 40 years. Its cutting edge technological know-how has made it the indispensable partner of the main international players in OEM and AFT (aftermarket).

After giving our contribution to the TGV's world speed record at 574.8 km/hr with our bearings in all TGV components (bearing axle boxes, transmissions and electrical drive motors), SNR is the first bearing manufacturer officially approved at 350 km/hr for axle bearings.

To efficiently meet the strong expectations from our clients, taking into account extreme conditions incurred by the bearings, SNR implements best technical solutions (material, design) and also develops innovative processes for surface treatments such as phosphating, copper plating or nitriding.

SNR also allows you to benefit from its reliable maintenance analysis tools.

To optimize solution integration and to ensure the excellence and responsiveness of its maintenance services: fitting advice and assistance on site, assembly of series solutions on site, bearing training, axle blocks bearings maintenance and reconditioning...

KTX Train, Korea
774 tonnes
300 km/h
935 passengers

Bearings: SNR

Reading the newspaper at 300 km/h seems natural to passengers today. However, this achievement is only made possible by detailed work on every mechanical component. SNR plays a major role in this research, and with the experience of its specialists, produces bearings suitable for the most extreme conditions.

Our bearings are all around you

www.snr-bearings.com



For more information, ask for our brochure dedicated to this sector.

Other applications

Our capacity to design bearings which integrate complementary, innovative functions (instrumentation, solid lubrication, ...) and our dedication to work in cooperation with our clients to pool our competences are the reasons for our presence in the major industrial markets and in higher diversified applications. From textile to rail and including film drawing machines, paper mills, iron & steel, agri-food, or even farming and bobbin-winding machinery..., SNR is present everywhere.

SNR and quarries - mines

■ The SNR career in quarries... The most severe applications

The work done in a quarry is more than just the extraction of the ore. A complete mechanical process is required to obtain a product with a specific granularity: crushing, grinding, screening process.

Heavy radial load, contamination, shocks, unbalanced load, vibration, high temperatures that can exceed 100°C (212°F), low rotating speed, misalignments: these are environmental constraints of a quarry.



SNR offers an extensive line of product, particularly PREMIER spherical roller bearings in steel cage or machined brass cage (or in special shaker screen, EF800 series) to withstand difficult operating conditions.

For each step in the ore process, SNR has just the right bearing.



For more information, ask for our brochure dedicated to this sector.



SNR and paper mill industry

■ SNR bearings: the sense of the fiber...

The transformation of a tree trunk into spotless paper requires a large number of operations. Working and treating the fibrous mass resulting from the wood involves the use of numerous machines, in which bearings are key components.

The paper environment is particularly difficult : presence of water and hot steam, high speeds of rotation and heavy loads, need for rotational accuracy, high temperature, aggressive chemical products particularly during the bleaching process, dust...



To face the numerous constraints in this sector, SNR proposes a range of bearings addressing the needs of paper mills, the Premier spherical roller bearings.

For accessory application (pumps, motors,...), our range of standard bearings is perfectly adapted.

SNR offers the paper mill Industry the appropriate solution for each step of the papermaking process.



For more information, ask for our brochure dedicated to this sector.

SNR and steel Industry

■ SNR bearings: as strong as iron & steel

Steel Industry process consists in transforming rough ore into value added steel, which have precise characteristics.

Due to high temperatures and loads, this sector imposes unmatched requirements on bearings.



The application conditions supported by the bearings are variable but always very difficult: very high pressures (rolling), high temperatures and heavy loads, humidity (water projection cooled the high temperature parts), vibration and shocks.

SNR develops products interchangeable with those in your machines :

- either standard bearings with performance optimized by shields or seals and appropriate clearance and grease;
- or, our special bearings designed to meet your specific needs, with identical dimensions to those of the bearings currently in place: no modifications are required.

The EF800 Premier spherical roller bearings for conveyors, shaker screen applications. The pillow block housing SNC bearings and the SNR carrier rollers and drive rollers are also major assets for your iron and steel equipment.



For more information, ask for our brochure dedicated to this sector.

SNR and agri-food industry

■ **SNR bearings: the indispensable ingredient in the agri-food process**

New ingredients, new modes of consumption, new preservation processes, the food industry is a fast-changing market. The industrial facilities must maintain high performance and reliability to guarantee sustained productivity.

In the agri-food industry, bearings must perform in: high and low temperatures, wet areas and water splashing, vibrations, misalignment...

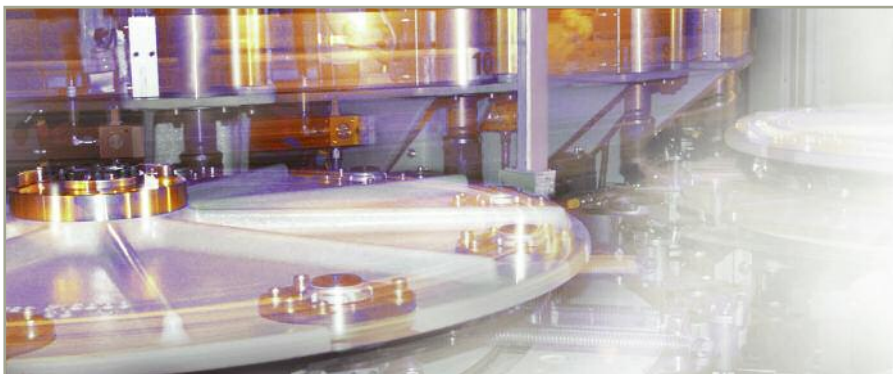

SNR has been present for years in many agri-food systems. Each trade has its own particulars requiring specific solutions in regards to bearings. Therefore, all SNR products have mechanical, thermal and chemical properties which address these requirements. Our TOPLINE range, our stainless steel bearings and bearing units meet all your expectations.



For more information, ask for our brochure dedicated to this sector.



Mechatronics

SNR Mechatronics

	702
■ Customized Motion Sensing	702
■ Development and Production	703
■ Production	703
■ Engineering	704
■ Magnetic encoders	704
■ Sensing elements	704
■ ASB® - Active Sensor Bearing	705
■ SLE - Sensorline Encoder	705
■ Radial sensor	706
■ Motor racing: Pescarolo Sport	706
■ Brushless motor	707

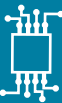

SNR Mechatronics – Customized Motion Sensing

■ SNR Mechatronics was created in 2002 to develop the SNR group's mechatronic activities. The division is seen as a pioneer in sensor bearings.

SNR Mechatronics proposes solutions, either integrated or not for bearings involved in speed or position sensing.

We were the first to introduce a sensor bearing for motorcar wheels integrating a magnetic encoder and an active sensor.

ASB is a major innovation which has now become a standard nearly adopted by all automotive manufacturers in Europe and Japan.

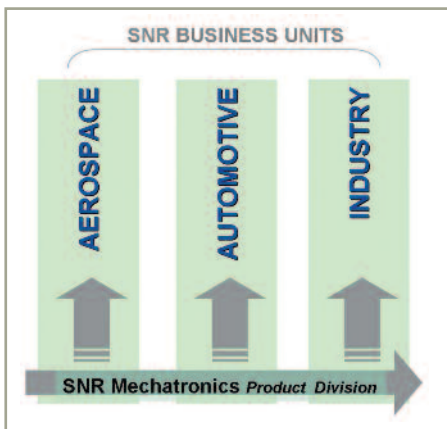
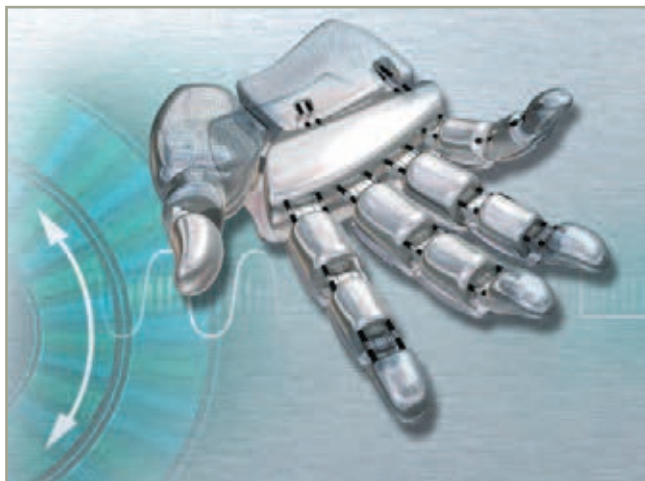

Thanks to our experience in high-precision applications, we have developed and manufactured mechatronic products for more than 15 years. This know-how, together with high professionalism in Automotive, Aerospace and Industrial sectors lead us to offer "tailor-made" products for full satisfaction of our clients.

Today, our ambition is to propose specific solutions for each demand in our activity sectors.

Development and Production

■ SNR Mechatronics is based on a unique magnetising process (magnetic encoder) and perfectly adapted magnetic sensing technologies (magneto-resistors, Hall-effect elements, SNR-proprietary ASIC, "Application-Specific Integrated Circuit") to develop specific applications. We can deliver high resolution signals for speed measurement, angle or direction sensing, and reference pulse generation for short-distance rotation or linear measurements.



Most of the new developments are specific and require fine studies which involve our basic technology. SNR Mechatronics possesses all resources required for designing these solutions: design and simulation tools, test laboratories and prototype processes.

Our specialists in each one of the Automotive, Industrial or Aerospace domains are fully liable for the management of the mechatronics projects from pre-design studies to serial-production. By combining SNR Mechatronics's expertise with the know-how of all SNR divisions, we ensure reliable, strict and economical studies for you.

Production

■ The SNR production sites integrate sophisticated production lines and test and monitoring equipment for our mechatronics products. SNR uses electronic components from the market leaders.

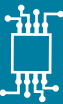
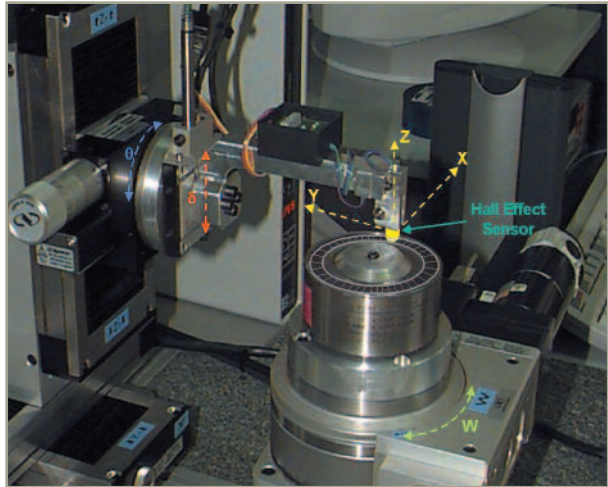

Engineering

■ We have a deep experience and strong know-how in displacement/motion sensors, magnetism, microelectronics, software and mechanical integration. Based on our clients' needs and activity field, our experts from the various company's sectors control the project from the beginning to the end.

We develop high competence in magnetic sensing: writing and reading magnetic data from an angular or linear encoder is the basic technology of our solutions.

This technology delivers a high resolution output signal for angular rotation rate and direction, and reference pulse generation.

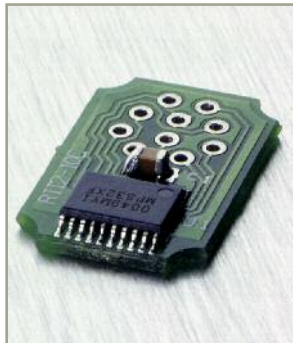

Magnetic encoders

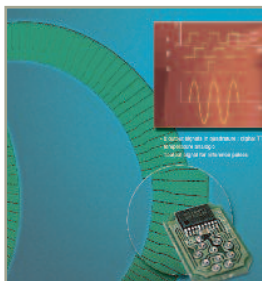

■ The use of magnetic data supports built from elastomer base magnetic materials lead us to develop a unique know-how in simulation, materials and system design, as well as writing and final inspection processes.

Magnetic encoding is ensured either in single track mode, as in the ASB product, or in bi-track which then integrates a much richer information base, whenever the SNR-proprietary ASIC reading head MPS40S is used.

Sensing elements

■ The SNR-proprietary Hall effect ASIC, MPS40S, is designed for simultaneous reading of 2 encoded magnetic tracks. It controls two quadratic signals on one of the tracks and one or more reference pulses on the other. Its main property lies in its capacity to interpolate up to 40 times the excitation magnetic encoding resolution. Therefore, a multipolar target with 32 pairs of poles can generate up to 1,280 pulses/revolution (5,120 fronts).

Temperature compensation (-40/+125°C) is integrated, as well as automatic gap variation compensation between ASIC and magnetic target during utilisation.

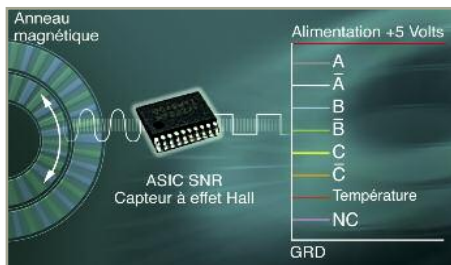

ASB® - Active Sensor Bearing

■ ASB® is an SNR registered trademark pertaining to the innovative wheel speed sensor bearing technology, an application which has been in high volume automobile production since 1997.

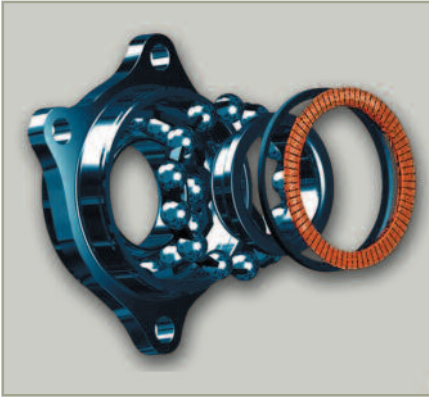

ASB® is a wheel bearing incorporating a rotating magnetic encoder seal, able to activate a tiny active sensor located close by.

The multipole magnetic encoder is made up of an elastomer-based anisotropic magnetic material, saturated by means of a specific magnetisation process. The active sensor which integrates a Hall effect sensor and a magneto-resistant element is attached to the bearing by a clip or more conventionally screwed to the Knuckle.

Any type of modern wheel bearing may be fitted with ASB technology

With the quality of signals provided (zero speed, rotation direction, etc.) through ASB®, SNR has opened up new possibilities for automobile designers.

An example of the type of products SNR Mechatronics is able to design for you is SLE.

SLE – Sensorline Encoder

■ **Sensor Line Encoder:** a high resolution increment encoder integrated in a bearing.

By integrating a by-track magnetic encoder and an SNR-proprietary ASIC, MPX32X (first generation SNR ASIC) in a bearing, the Sensor Line Encoder provides reliable measurements in a very compact envelope. It operates as a bearing, easily integrated into a mechanical environment, and benefits from SNR's experience in bearing instrumentation.

Our company's experience also guarantees bearing precision and durability: two vital conditions for reliable measurements.

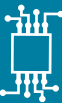

Radial sensor

■ SNR developed a high resolution radial speed sensor with rotating direction indication (Power supply in 5V or in 8-30V. Interfaces: Push/pull 15mA (Standard) and optionally RS422, Push/Pull 50mA, or Open Drain).

These sensors operate with radial magnetic encoders available in-house at SNR, in various diameters.

On request, SNR Mechatronics can develop specific encoders tailored to the application, either in specific diameters or in terms of the number of pairs of poles.

For an encoder with 48 pairs of poles, the sensor can deliver the following information: 48, 96, 192, 384, 768, 1,536 periods/channel/revolution.

Depending on the operating electronic circuitry, you can obtain information on rotational speed, relative displacement and rotating direction.

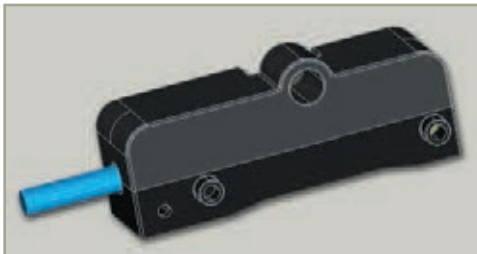

Motorcar racing: Pescarolo Sport

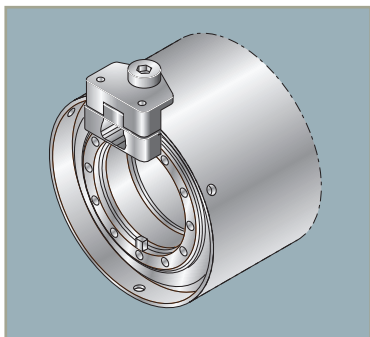

■ The flexibility of our technology enabled Pescarolo Sport to equip its Le Mans racing cars with high resolution wheel speed sensors: a vital information for measurement of the car behaviour during the race, and for timely intervention as required. As is often the case, technologies developed for racing will then be applied to daily industrial designs.



Brushless motor

■ The by-track magnetic encoding technology associated with the SNR-proprietary ASIC, MPS40S, allows efficient control of brushless DC motors (DLDC). In fact, the track which generated the reference pulses will ensure switching control whereas the "high resolution" track allows torque variation control (torque ripple).

The SNR technology is highly reputed for compact design. In fact, the optimised magnetic encoder is preferably integrated to a bearing, without changing its external dimensions.



ASIC integrates signal processing functions which appreciably reduce the sensor's footprint.

